



# StorageTek SL3000

## Modular Library System

**User's Guide**

Part Number: 316194401

Revision AC





# Sun StorageTek™ SL3000

User's Guide

Revision AC

Sun Microsystems, Inc.  
[www.sun.com](http://www.sun.com)

Part No. 316194401  
September 2009, Revision AC

Submit comments about this document by clicking the Feedback[+] link at: <http://docs.sun.com>



Sun Microsystems, Inc.  
[www.sun.com](http://www.sun.com)

Submit comments about this document by clicking the Feedback[+] link at: <http://docs.sun.com>

Copyright 2007–2009 Sun Microsystems, Inc., 4150 Network Circle, Santa Clara, California 95054, U.S.A. All rights reserved.

Sun Microsystems, Inc. has intellectual property rights relating to technology that is described in this document. In particular, and without limitation, these intellectual property rights may include one or more of the U.S. patents listed at <http://www.sun.com/patents> and one or more additional patents or pending patent applications in the U.S. and in other countries.

This document and the product to which it pertains are distributed under licenses restricting their use, copying, distribution, and decompilation. No part of the product or of this document may be reproduced in any form by any means without prior written authorization of Sun and its licensors, if any.

Third-party software, including font technology, is copyrighted and licensed from Sun suppliers.

Parts of the product may be derived from Berkeley BSD systems, licensed from the University of California. UNIX is a registered trademark in the U.S. and in other countries, exclusively licensed through X/Open Company, Ltd.

Sun, Sun Microsystems, the Sun logo, Java, AnswerBook2, docs.sun.com, Solaris, and StorageTek are trademarks or registered trademarks of Sun Microsystems, Inc. in the U.S. and in other countries.

All SPARC trademarks are used under license and are trademarks or registered trademarks of SPARC International, Inc. in the U.S. and in other countries. Products bearing SPARC trademarks are based upon an architecture developed by Sun Microsystems, Inc.

The OPEN LOOK and Sun™ Graphical User Interface was developed by Sun Microsystems, Inc. for its users and licensees. Sun acknowledges the pioneering efforts of Xerox in researching and developing the concept of visual or graphical user interfaces for the computer industry. Sun holds a non-exclusive license from Xerox to the Xerox Graphical User Interface, which license also covers Sun's licensees who implement OPEN LOOK GUIs and otherwise comply with Sun's written license agreements.

U.S. Government Rights—Commercial use. Government users are subject to the Sun Microsystems, Inc. standard license agreement and applicable provisions of the FAR and its supplements.

DOCUMENTATION IS PROVIDED "AS IS" AND ALL EXPRESS OR IMPLIED CONDITIONS, REPRESENTATIONS AND WARRANTIES, INCLUDING ANY IMPLIED WARRANTY OF MERCHANTABILITY, FITNESS FOR A PARTICULAR PURPOSE OR NON-INFRINGEMENT, ARE DISCLAIMED, EXCEPT TO THE EXTENT THAT SUCH DISCLAIMERS ARE HELD TO BE LEGALLY INVALID.

Copyright 2007–2009 Sun Microsystems, Inc., 4150 Network Circle, Santa Clara, Californie 95054, Etats-Unis. Tous droits réservés.

Sun Microsystems, Inc. a les droits de propriété intellectuels relatants à la technologie qui est décrit dans ce document. En particulier, et sans la limitation, ces droits de propriété intellectuels peuvent inclure un ou plus des brevets américains énumérés à <http://www.sun.com/patents> et un ou les brevets plus supplémentaires ou les applications de brevet en attente dans les Etats-Unis et dans les autres pays.

Ce produit ou document est protégé par un copyright et distribué avec des licences qui en restreignent l'utilisation, la copie, la distribution, et la décompilation. Aucune partie de ce produit ou document ne peut être reproduite sous aucune forme, par quelque moyen que ce soit, sans l'autorisation préalable et écrite de Sun et de ses bailleurs de licence, s'il y en a.

Le logiciel détenu par des tiers, et qui comprend la technologie relative aux polices de caractères, est protégé par un copyright et licencié par des fournisseurs de Sun.

Des parties de ce produit pourront être dérivées des systèmes Berkeley BSD licenciés par l'Université de Californie. UNIX est une marque déposée aux Etats-Unis et dans d'autres pays et licenciée exclusivement par X/Open Company, Ltd.

Sun, Sun Microsystems, le logo Sun, Java, AnswerBook2, docs.sun.com, Solaris et StorageTek sont des marques de fabrique ou des marques déposées de Sun Microsystems, Inc. aux Etats-Unis et dans d'autres pays.

Toutes les marques SPARC sont utilisées sous licence et sont des marques de fabrique ou des marques déposées de SPARC International, Inc. aux Etats-Unis et dans d'autres pays. Les produits portant les marques SPARC sont basés sur une architecture développée par Sun Microsystems, Inc.

L'interface d'utilisation graphique OPEN LOOK et Sun™ a été développée par Sun Microsystems, Inc. pour ses utilisateurs et licenciés. Sun reconnaît les efforts de pionniers de Xerox pour la recherche et le développement du concept des interfaces d'utilisation visuelle ou graphique pour l'industrie de l'informatique. Sun détient une licence non exclusive de Xerox sur l'interface d'utilisation graphique Xerox, cette licence couvrant également les licenciées de Sun qui mettent en place l'interface d'utilisation graphique OPEN LOOK et qui en outre se conforment aux licences écrites de Sun.

LA DOCUMENTATION EST FOURNIE "EN L'ÉTAT" ET TOUTES AUTRES CONDITIONS, DECLARATIONS ET GARANTIES EXPRESSES OU TACITES SONT FORMELLEMENT EXCLUES, DANS LA MESURE AUTORISEE PAR LA LOI APPLICABLE, Y COMPRIS NOTAMMENT TOUTE GARANTIE IMPLICITE RELATIVE A LA QUALITE MARCHANDE, A L'APTITUDE A UNE UTILISATION PARTICULIERE OU A L'ABSENCE DE CONTREFAÇON.



# Summary of Changes

EC	Date	Revision	Description
—	September 2009	AC	<p>Updated for the following features:</p> <ul style="list-style-type: none"><li>■ Cleaning cartridge import – See the following sections for details:<ul style="list-style-type: none"><li>■ <a href="#">“CAP Assignment Mode” on page 81</a></li><li>■ <a href="#">“Managing Automatic Cleaning Through the SL Console” on page 92</a></li><li>■ <a href="#">“Change the CAP Assignment Mode for an FC-SCSI Library” on page 138</a></li><li>■ <a href="#">“Enter Cleaning or Diagnostic Cartridges” on page 183</a></li><li>■ <a href="#">“Eject Cleaning or Diagnostic Cartridges” on page 184</a></li></ul></li><li>■ SCSI FastLoad – See the following sections for details:<ul style="list-style-type: none"><li>■ <a href="#">“SCSI FastLoad Feature” on page 94</a></li><li>■ <a href="#">“Configure SCSI FastLoad in a Non-Partitioned Library” on page 189</a></li><li>■ <a href="#">“Configure SCSI FastLoad for a Partition” on page 191</a></li></ul></li><li>■ Barcode presentation – See the following sections for details:<ul style="list-style-type: none"><li>■ <a href="#">“Barcode Presentation” on page 88</a></li><li>■ <a href="#">“Configure Barcode Presentation in a Non-Partitioned FC-SCSI Library” on page 147</a></li><li>■ <a href="#">“Configure Cartridge Barcode Presentation for an FC-SCSI Partition” on page 149</a></li></ul></li><li>■ Cartridge Table report – See the following sections for details:<ul style="list-style-type: none"><li>■ <a href="#">“Display Library Cartridge Information in Tabular Format” on page 151</a></li></ul></li></ul>

EC	Date	Revision	Description
	September 2009 (continued)	AC	<ul style="list-style-type: none"> <li>■ Linux local operator panel – See the following sections for details:               <ul style="list-style-type: none"> <li>■ “Virtual Keypad” on page 40</li> <li>■ “Touch Screen Calibration” on page 41</li> <li>■ “Re-calibrate the Local Operator Panel” on page 62</li> <li>■ “Reset the Local Operator Panel Calibration” on page 65</li> </ul> </li> </ul>
EC001137	May 2009	AB	<p>Updated for the following features:</p> <ul style="list-style-type: none"> <li>■ Access Expansion Module (AEM) – See the following sections for details:               <ul style="list-style-type: none"> <li>■ “Access Expansion Module” on page 15</li> <li>■ “CAP Operations” on page 79</li> <li>■ “AEM Operations” on page 84</li> <li>■ “Rotational and AEM CAP Management Tasks” on page 126</li> <li>■ “Cartridge Management Tasks” on page 140</li> <li>■ “AEM Safety Door Management Tasks” on page 198</li> <li>■ “Partitions and Rotational and AEM CAPs” on page 275</li> <li>■ “AEM Safety Door Utility Tasks” on page 471</li> <li>■ “Manual Operation Tasks” on page 478</li> <li>■ FIGURE B-5, “Access Expansion Module Walls” on page 514</li> </ul> </li> <li>■ Non-disruptive library capacity changes. See “Non-disruptive Capacity Changes” on page 227.</li> <li>■ Non-disruptive partitioning. See “Non-Disruptive Partitioning” on page 280.</li> <li>■ Status alert messages. See “Status Alert Messages” on page 78.</li> <li>■ Library energy monitor reports. See the following:               <ul style="list-style-type: none"> <li>■ “Display the “Last 24 Hours” Library Energy Monitor Report” on page 120</li> <li>■ “Display the “Last Month” Library Energy Monitor Report” on page 122</li> <li>■ “Display the “Last Year” Library Energy Monitor Report” on page 124</li> </ul> </li> </ul>



<b>EC</b>	<b>Date</b>	<b>Revision</b>	<b>Description</b>
EC001137 continued	May 2009	AB	<ul style="list-style-type: none"> <li>■ Drive and media events reports. See the following: <ul style="list-style-type: none"> <li>■ <a href="#">“Display the Media Events Report” on page 165</a></li> <li>■ <a href="#">“Display the Drive Events Report” on page 176</a></li> <li>■ <a href="#">“Display the Drive Media Events Report” on page 178</a></li> </ul> </li> <li>■ Log snapshot file. See the following: <ul style="list-style-type: none"> <li>■</li> </ul> </li> </ul>
EC000348	April 2008	A	Initial release



# Contents

## **Preface xxxi**

Organization xxxi

Alert Messages xxxii

Conventions xxxiii

Related Documentation xxxiii

Documentation, Support, and Training xxxv

Third-Party Web Sites xxxv

Sun Welcomes Your Comments xxxv

## **1. SL3000 Introduction 1**

SL3000 Features 2

Modular Design 3

    Modules 3

    CenterLine Technology 3

    Any cartridge, Any slot™ Technology 5

    Physical Capacities 5

    Optional Fire/Smoke Detection 5

Base Module 7

Drive Expansion Module 10

Cartridge Expansion Module 13

Parking Expansion Module 14

Access Expansion Module 15

Tape Drives 17

    Drive Trays 18

Cartridge Access Ports 19

Robotics Units	20
Redundant (Dual) TallBots	21
Power Options	22
AC Power Configurations	22
Power Redundancy	22
DC Power	22
Cooling	23
Library Electronics	23
Tape Drives	23
DC Power Supplies	23
Interfaces	24
Library Control Path	24
TCP/IP Interface	24
FC-SCSI Interface	26
Data Path	26
Command Line Interface	27
SNMP	27
SL Console	27
Library Management Software	28
Nearline Control Solutions	28
Host Software Component	28
Storage Management Component	29
Sun StorageTek HTTP Server	29
Automated Cartridge System Library Software (ACSLs)	29
Operating Modes	30
Automated Mode	30
Manual Mode	30
Maintenance Mode	30
Degraded Mode	31
<b>2. StorageTek Library Console</b>	<b>33</b>
Introduction	33
SL Console Modes	33
SL Console Security	34

User IDs	34
Activation Password	34
SL Console Screen Display	35
Modifying the Screen Layout	36
Synchronizing the Display With the Controller Database	36
Logging In	36
Making Library Configuration Updates	36
SL Console Help	38
Accessing the SL Console Help	38
Help Navigation	38
Tips for Using the SL Console Help	39
Local Operator Panel	40
Virtual Keypad	40
Touch Screen Calibration	41
Web-launched SL Console	42
Security Considerations	42
Client Requirements	42
Web-launched SL Console Updates	42
Starting the Web-launched SL Console on a Client	43
Standalone SL Console	44
Security Considerations	44
Installation Requirements	44
Standalone SL Console Updates	45
SL Console Task Summary	46
General SL Console Usage Tasks	47
Log in to the Local Operator Panel	48
Log in to the Web-launched SL Console Using a Browser or Command Line	49
Log in to the Web-launched SL Console Using an Icon	54
Log in to the Standalone SL Console	58
Log Off the SL Console	59
Change a User Password	60
Local Operator Panel Calibration Tasks	61
Re-calibrate the Local Operator Panel	62

Reset the Local Operator Panel Calibration	65
Standalone SL Console Installation Tasks	66
Download the Standalone SL Console Installer	67
Install the Standalone SL Console	68
<b>3. SL3000 Automated Library Operations</b>	<b>73</b>
Automated Mode of Operation	73
Cartridge Mount and Dismount Activities	73
Mount Sequence	73
Dismount Sequence	74
Determining When the Library is Not in Automated Mode	74
Library and Device Status	75
Communications Failures	76
Library Reports	77
Report Types	77
Report Options Bar	77
Status Alert Messages	78
CAP Operations	79
Rotational CAPs	79
AEM CAPs	79
CAP Open Sequence	79
CAP Close Sequence	80
CAP Auto Enter Mode	80
Manual CAP Mode	80
CAP States	80
CAP Assignment Mode	81
CAP Priorities for Cartridge Ejects by FC-SCSI Hosts	81
Using CAPS in a Partitioned Library	82
Additional CAP Information	83
AEM Operations	84
AEM Access Door	84
AEM Safety Door	84
AEM CAP Functions	85
Partitions and AEMs	85

Non-disruptive Maintenance	85
Additional AEM Information	85
Cartridge Management	87
Entering Cartridges	87
Ejecting Cartridges	87
Locating Cartridges	88
Barcode Presentation	88
Recovery Moves	89
Cartridge Management Procedures	89
Drives	90
Drive Identification	90
Drive States	90
Drive Management Procedures	90
Drive Cleaning	91
Cleaning Cartridges	91
Ejecting Expired Cleaning Cartridges	91
Managing Automatic Cleaning Through the SL Console	92
Importing and Exporting Cleaning Cartridges	92
Manual Cleaning	92
Drive Cleaning Procedures	93
TallBots	94
SCSI FastLoad Feature	94
TallBot Procedures	95
Power Supplies	96
Power Supply Procedures	96
Host Interface Type	97
Non-Partitioned Libraries	97
Partitioned Libraries	97
Special Configuration Options for FC-SCSI Libraries	97
SCSI FastLoad	97
Barcode Presentation	98
Automated Operation Tasks	99
Library Management Tasks	100

Display Library Status	101
Display Library Status Alerts	102
Clear Library Status Alerts	104
Display HLI Port Status	106
Display FC-SCSI Port Status	107
Display Library Configuration Information	108
Display Library Controller Properties	109
Display Drive Controller Properties	110
Change the Library Interface Type (Non-Partitioned Libraries)	111
Display a Library Report	114
Search a Library Report	116
Save Library Report Data to a File	118
Display the "Last 24 Hours" Library Energy Monitor Report	120
Display the "Last Month" Library Energy Monitor Report	122
Display the "Last Year" Library Energy Monitor Report	124
Rotational and AEM CAP Management Tasks	126
Display Rotational and AEM CAP Summary Information	127
Display Current Rotational or AEM CAP Status	128
Display Rotational or AEM CAP Properties	131
Unlock a CAP or AEM Access Door	134
Lock a CAP or AEM Access Door	136
Change the CAP Assignment Mode for an FC-SCSI Library	138
Cartridge Management Tasks	140
Enter Cartridges Through a Rotational CAP	141
Eject Cartridges Through a Rotational CAP	142
Bulk Load Cartridges Through an AEM CAP	143
Bulk Unload Cartridges Through an AEM CAP	145
Configure Barcode Presentation in a Non-Partitioned FC-SCSI Library	147
Configure Cartridge Barcode Presentation for an FC-SCSI Partition	149
Display Library Cartridge Information in Tabular Format	151
List Library Cartridges	154
Locate a Cartridge by VOLID	157
Locate a Cartridge by Address	159



Move a Specified Cartridge by VOLID	161
Move a Cartridge From a Specified Location	163
Display the Media Events Report	165
Drive Management Tasks	167
Display Drive Summary Information	168
Display Drive Status	170
Display Drive Properties	171
Display Drive VOP	172
Display Drive Network Data	173
Display Drive LED Status	174
Display Drive Tray Status	175
Display the Drive Events Report	176
Display the Drive Media Events Report	178
Drive Cleaning Tasks	180
Configure Drive Auto Clean	181
Enter Cleaning or Diagnostic Cartridges	183
Eject Cleaning or Diagnostic Cartridges	184
Display Cleaning Cartridges	185
Display Drive Cleaning Status	186
Clean a Drive Manually	187
Robot and Power Supply Tasks	188
Configure SCSI FastLoad in a Non-Partitioned Library	189
Configure SCSI FastLoad for a Partition	191
Display Robot Summary Information	193
Display Robot Status	194
Display Robot Properties	195
Display Power Supply Summary Information	196
Display Power Supply Detail	197
AEM Safety Door Management Tasks	198
Display AEM Safety Door Status	199
Display AEM Safety Door Properties	200
<b>4. Licensing</b>	<b>201</b>
License Key File	201

License Expirations	202
Licensing Tasks	203
License Installation Process	203
Licensing Task Summary	204
Receive a New License Key File	205
Display and Verify New License Contents	206
Install a New License on the Target Library	209
Display Current Library License	212
Licensing Screen Reference	213
License Management > Current License	214
License Management > Install License	216
License Management > Install License—Compare	219
License Management > Install License—Install	221
<b>5. Capacity on Demand</b>	<b>223</b>
Capacity on Demand Features and Restrictions	223
Terminology	224
Active Storage Region Configuration	224
Cell Activation Rules	225
Non-Partitioned Libraries	225
Partitioned Libraries	225
De-activating Storage Capacity	225
Orphaned Cartridges in Non-Partitioned Libraries	226
Non-disruptive Capacity Changes	227
Active Capacity Changes and HLI Connections	227
Adding Active Capacity	227
Removing Active Capacity	227
Active Capacity Changes and FC-SCSI Connections	228
Increasing Licensed Capacity	229
Decreasing Licensed Capacity	229
Capacity Management Tasks	230
Storage Capacity Installation Process	230
SL Console Active Storage Region Workspace	230
Capacity Management Tasks	232

Define Active Storage Regions	233
Commit Active Storage Region Changes	236
Display an Active Storage Region Report	239
Print Active Storage Region Report Data	241
Save Active Storage Region Report Data	242
Display Active Cell Detail	243
Active Storage Region Screen Reference	245
Select Active Cells > Module Map	246
Select Active Cells > Select Active Cells	248
Select Active Cells > Select Active Cells—Confirm Apply	254
Select Active Cells—View Reports	257
Select Active Cells—View Reports—Cartridge Cell and Media Summary	259
Select Active Cells—View Reports—Orphaned Cartridge Report	262
Select Active Cells—Current Active Cells	264
<b>6. Library Partitioning</b>	<b>267</b>
Partitioning Features and Restrictions	267
Enabling and Disabling Partitioning	268
Partition Planning	268
Installing the Partitioning Feature	268
Allocated Storage Capacity	268
Partition Configurations	269
Partition Summary Information	269
Host-Partition Connections	269
Partition Boundaries	270
Partitions and Library Resources	270
Library Resource Addresses	270
Library Internal Address	271
Host FC-SCSI Element Address	271
HLI-PRC Address	272
Storage Cells and Drives	273
Orphaned Cartridges in Partitioned Libraries	273
Partitions and Rotational and AEM CAPs	275
Using CAPS in a Partitioned Library	275

CAP Allocations	275
Shared CAPs	276
CAP Auto Enter Mode	276
CAP “Ownership”	276
CAP States	277
CAP Reservations	278
HLI CAP Reservations	278
FC-SCSI CAP Reservations	279
Shared FC-SCSI CAP Associations	279
Non-Disruptive Partitioning	280
NDP and HLI Partitions	280
Allocating Additional Resources to a Partition	280
Removing Allocations from a Partition	281
NDP and FC-SCSI Partitions	281
Host Connection Changes	281
Partition Configuration Changes	281
Partitioning Process	283
Partition Configuration Process	283
SL Console Partition Workspace	284
Partitioning Task Summary	285
Partition Configuration Tasks	286
Review Partitioning Instructions	287
Create a Partition	288
Configure a Host-Partition Connection	289
Design a Partition – Base, DEM, or CEM Modules	291
Design a Partition – AEM Modules	294
Verify Partition Configurations	296
Resolve Orphaned Cartridges	299
Commit Partition Configuration Changes	300
Partition Management Tasks	303
Modify Partition Summary Information	304
Delete a Partition	305
Modify the Interface Type of a Host-Partition Connection	307

Modify FC-SCSI Host-Partition Connection Detail	309
Delete a FC-SCSI Host-Partition Connection	311
Refresh the SL Console Partition Workspace	313
Reallocate Library Resources	314
Make a Hardware Change to a Partitioned Library	315
Partition Report Tasks	316
Display a Partition Report	317
Print Partition Report Data	319
Save Partition Report Data	320
Display Partition Detail	321
CAP Operation Tasks	323
Associate an FC-SCSI Partition to Its Shared CAPs	324
Enter Cartridges Into a Partition	326
Eject Cartridges From a Partition	327
Remove a Partition-CAP Association	328
Override a CAP Reservation	329
Partition Screen Reference	332
Partition Summary Screens	333
Partitions—Instructions (Step 1)	334
Partitions—Summary (Step 2)	336
Partitions—Summary (Step 2)—Add Connection	342
Partitions—Summary (Step 2)—Delete Connection	344
Partitions—Summary (Step 2)—Modify Connection	346
Partitions—Summary (Step 2)—Add Partition	348
Partitions—Summary (Step 2)—Delete Partition	350
Partitions—Summary (Step 2)—Modify Partition	351
Partition Design and Commit Screens	353
Partitions—Module Map (Step 3a)	354
Partitions—Design (Step 3b)	356
Partitions—Design (Step 3b) - AEMs Only	362
Partitions—Design (Step 3b)—Verify Results	368
Partitions—Commit (Step 4)	371
Partitions—Commit (Step 4)—Confirm Apply	374

Partitions—Current Partition Definitions	377
Partition Report Screens	379
Partitions—Reports	380
Partitions—Reports—Cartridge Cell and Media Summary	382
Partitions—Reports—Host Connections Summary	385
Partitions—Reports—Orphaned Cartridge Report	388
Partitions—Reports—Partition Details	391
Partitions—Reports—Partition Summary	395
Partition CAP Operation Screens	398
Shared CAP Assignment	399
Diagnostics > CAP—Unreserve	402
<b>7. SL Console Diagnostics and Utilities</b>	<b>405</b>
Library Events	405
Event Monitors	405
Library Self-Tests	406
Library Firmware Upgrades	407
Firmware Download Site	407
Firmware Installation Process	407
Audits	408
Physical Audit	408
Verified Audit	409
Robot Diagnostic Moves	410
Target Address Range	410
Pool Address Range	410
Move Access Order	411
Sequential Access Order	411
Random Access Order	411
Robot Selection	411
Diagnostic Move Control Functions	411
Troubleshooting	413
Diagnostic Support Files	415
MIB File	415
Library Log Snapshot File	415

Diagnostic and Utility Tasks	416
Event Monitor Tasks	417
Display an Event Monitor	418
Spool Event Monitor Data to a File	419
Display Multiple Monitors	420
List a Device Status Code	421
List a Result Code	423
Library Utility Tasks	424
Perform a Library Self-Test	425
Reboot the Library	426
Download Code to the Library Controller	428
Activate Code on the Library Controller	430
Transfer the Library MIB File	432
Transfer the Library Log Snapshot File	434
Audit Tasks	437
Audit the Entire Library	438
Audit a Range of Cells	440
Perform a Verified Audit	442
Rotational and AEM CAP Utility Tasks	444
Perform a Self-Test on a Rotational or AEM CAP	445
Vary a Rotational or AEM CAP Offline	446
Vary a Rotational or AEM CAP Online	448
Drive Utility Tasks	450
Perform a Drive Self-Test	451
Vary a Drive Offline	452
Vary a Drive Online	453
TallBot Utility Tasks	454
Perform a TallBot Self-Test	455
Vary a TallBot Offline	456
Vary a TallBot Online	457
Define a Diagnostic Move	458
Manage Diagnostic Move Definitions	463
Save a Diagnostic Move to a File	465

	Start a Diagnostic Move	467
	Monitor and Control Open Diagnostic Moves	469
	AEM Safety Door Utility Tasks	471
	Reboot an AEM Safety Door	472
<b>8.</b>	<b>Manual Operations</b>	<b>475</b>
	Library Safety	475
	General Safety Precautions	475
	SL3000 Door Interlocks	476
	SL3000 Servo Power Interrupt	476
	Mechanical Door Releases	477
	Interior Lighting	477
	Physical Restrictions	477
	Manual Operation Tasks	478
	Vary the Library Offline	479
	Vary the Library Online	481
	Power Down the Library	483
	Power Up the Library	484
	Open the Library Main Access Door	486
	Close and Lock the Library Main Access Door	487
	Perform an AEM "Fast Access"	488
	Close the AEM Access Door After a "Fast Access"	489
<b>A.</b>	<b>Library Resource Addresses</b>	<b>491</b>
	CenterLine Technology	491
	Library Internal Address	493
	Storage Cells	493
	Library Internal Address Example – Base Module	493
	Library Internal Address Example – DEM	495
	System/Reserved Cells	496
	CAP Cells	497
	Library Internal Address Examples – CAP Cells	497
	HLI-PRC Locations	499
	Storage Cells	499



HLI-PRC Storage Cell Locations – Example One	500
HLI-PRC Storage Cell Locations – Example Two	500
HLI-PRC Storage Cell Locations – Example Three	501
Drive Slots	502
HLI-PRC Drive Locations – Example One	502
HLI-PRC Drive Locations – Example Two	503
CAP Cells	503
Rotational CAPs	503
AEM CAPs	503
FC-SCSI Element Locations	504
Drive Hardware Numbers	507
Drive Dynamic World-Wide Names	508
<b>B. Wall Diagrams</b>	<b>509</b>
Configuration Block	515
Row Numbering	516
Reserved/System Cells	517
<b>C. Cartridge Handling</b>	<b>519</b>
Cartridge Requirements	519
Valid Cartridge Labels	519
Media Domain and Media ID	520
Cleaning and Diagnostic Cartridges	520
Cartridge Codes	520
Sun StorageTek Tape Drives and Cartridges	521
LTO Tape Drives and Cartridges	521
Handling Cartridges	522
Inserting a Cartridge in a Drive or Cell	522
Unreadable Cartridges	523
Unlabeled Cartridges	523
Upside-Down Cartridges	523
Sun StorageTek Cartridges	523
LTO Cartridges	524
Maintaining Cartridges	524

Cleaning the Cartridge Exterior	524
Repairing a Detached Leader Block	524
Storing Cartridges	524
Ordering Cartridges and Labels	525
Apply the Label on a Cartridge	526
<b>D. Web-launched SL Console Server</b>	<b>527</b>
Security Considerations	527
Server Requirements	527
Server Installation and Management	528
▼ Download the Java System Web Server	528
Install the Sun Java System Web Server	532
Log in to the Java System Web Server Administration Console	536
Install and Deploy the Web-launched SL Console	539
Start the Web-launched SL Console	545
Update the Web-launched SL Console	547
Common Problems and Solutions	552
Windows 2000 Sun Java System Web Server Installation Errors	552
Windows MSVCP60.dll Error	552
▼ Remedy for Windows MSVCP60.dll Error	553
Solaris 9 & 10 Sun Java System Web Server Installation Errors	554
Java Home Error	554
▼ Remedy for Solaris Java Home Error	554

# Figures

FIGURE 1-1	SL3000 Modular Library System	1
FIGURE 1-2	Library Configurations Around CenterLine	4
FIGURE 1-3	Base Module – Front View	7
FIGURE 1-4	Base Module – Rear View Drawing	9
FIGURE 1-5	Drive Expansion Module – Front View	10
FIGURE 1-6	Drive Expansion Module – Rear View Drawing	12
FIGURE 1-7	Cartridge Expansion Module with Base Module	13
FIGURE 1-8	Parking Expansion Module	14
FIGURE 1-9	Access Expansion Module	16
FIGURE 1-10	Drive Tray	18
FIGURE 1-11	Cartridge Access Port	19
FIGURE 1-12	TallBot	20
FIGURE 8-1	Mechanical Door Release	477
FIGURE A-1	Centerline and Column Addressing	492
FIGURE B-1	Base Module Walls	510
FIGURE B-2	Drive Expansion Module Walls	511
FIGURE B-3	Cartridge Expansion Module Walls	512
FIGURE B-4	Parking Expansion Module Walls	513
FIGURE B-5	Access Expansion Module Walls	514
FIGURE B-6	Configuration Block	515
FIGURE B-7	Row Numbering	516
FIGURE B-8	Reserved Slots	517



# Tables

TABLE 1-1	Accessible Physical Cell Count Per Module	6
TABLE 1-2	Supported Tape Drives	17
TABLE 1-3	Power Options and Number of Drives	17
TABLE 7-1	Troubleshooting Table	413
TABLE A-1	Base Module – Rear Wall Locations (viewed from the front of the library)	493
TABLE A-2	Drive Expansion Module – Rear Wall Locations (viewed from the front of the library)	496
TABLE A-3	Reserved Cells	497
TABLE A-4	Host Library Interface Cell Locations – Example One	500
TABLE A-5	Host Library Interface Cell Locations – Example Two	500
TABLE A-6	Host Library Interface Cell Locations – Example Three	501
TABLE A-7	Host Library Interface Tape Drive Locations	502
TABLE A-8	FC-SCSI Element Locations – Back Walls (as viewed from the front))	505
TABLE A-9	FC-SCSI Element Locations – Front Walls (as viewed from the front)	506
TABLE A-10	Base Module Tape Drive Numbering – Hardware	507
TABLE A-11	Drive Expansion Module Tape Drive Numbering – Hardware	508
TABLE C-1	Sun StorageTek Cartridge Codes	521
TABLE C-2	LTO Cartridge Codes	521



# Preface

---

This guide is intended primarily for SL3000 library system administrators and operators. It can also be used by Sun StorageTek partners and support representatives.

Most of the information pertains to the library hardware, the StorageTek Library Console, and related operations. For specific drive information or for client application software commands, see the appropriate drive or software documentation.

---

## Organization

---

Chapter 1	<b>SL3000 Introduction.</b> Overview of the Sun StorageTek SL3000 modular library system features and functions.
Chapter 2	<b>StorageTek Library Console.</b> Topics and procedures for installing and using the SL Console graphical user interface.
Chapter 3	<b>SL3000 Automated Library Operations.</b> Topics and procedures for using the SL Console to configure, manage, and monitor the SL3000 library in automated mode.
Chapter 4	<b>Licensing.</b> Topics, procedures, and screen reference for installing and managing SL3000 feature licenses.
Chapter 5	<b>Capacity on Demand.</b> Topics, procedures, and screen reference for installing and managing SL3000 licensed capacity.
Chapter 6	<b>Library Partitioning.</b> Topics, procedures, and screen reference for installing and managing SL3000 library partitions.
Chapter 7	<b>SL Console Diagnostics and Utilities.</b> Topics and procedures for using the SL Console to perform diagnostic and utility functions on the SL3000 library.
Chapter 8	<b>Manual Operations.</b> Topics and procedures for safely using the SL3000 library in manual mode.
Appendix A	<b>Library Resource Addresses.</b> Reference information regarding storage cell, CAP, and drive addressing used with the SL3000 library.
Appendix B	<b>Wall Diagrams.</b> Detailed diagrams of storage cell, CAP, and drive layouts.

---

---

Appendix C	<b>Cartridge Handling.</b> Reference information on labeling and using cartridges in the SL3000 library.
Appendix D	<b>Web-launched SL Console Server.</b> Topics and procedures for installing and configuring the Web-launched SL Console server.
Index	Alphabetical list of topics in this manual.

---

---

## Alert Messages

Alert messages call your attention to information that is especially important or that has a unique relationship to the main text or graphic.

---

**Note** – A note provides additional information that is of special interest. A note might point out exceptions to rules or procedures.

---

---

**Caution** – A caution informs the reader of conditions that might result in damage to hardware, corruption of data, corruption of application software, or long-term health problems in people. A caution always precedes the information to which it pertains.

---

---

**Warning – Possible Physical Injury.** A warning alerts the reader to conditions that might result in injury or death. A warning always precedes the information to which it pertains.

---



---

# Conventions

Typographical conventions highlight special words, phrases, and actions in this publication.

Typeface*	Meaning	Examples
AaBbCc123	The names of commands, files, and directories; on-screen computer output	Edit your <code>.login</code> file. Use <code>ls -a</code> to list all files. % You have mail.
<b>AaBbCc123</b>	What you type, when contrasted with on-screen computer output	% <b>su</b> Password:
<i>AaBbCc123</i>	Book titles, new words or terms, words to be emphasized. Replace command-line variables with real names or values.	Read Chapter 6 in the <i>User's Guide</i> . These are called <i>class</i> options. You <i>must</i> be superuser to do this. To delete a file, type <code>rm filename</code> .

\* The settings on your browser might differ from these settings.

---

## Related Documentation

SL3000 Modular Library Publications	Part Number
<i>SL3000 Systems Assurance Guide</i>	3161941xx
<i>SNMP Guide for SL3000 Libraries</i>	3161945xx
<i>SL3000 Troubleshooting Guide</i>	4186091xx

<b>Tape Drive Documentation</b>	<b>Part Number</b>
<i>Hewlett Packard Ultrium Tape Drive Manual</i>	CD included with drive
<i>IBM Ultrium Tape Drive Manual</i>	CD included with drive
<i>T10000 Tape Drive Installation Manual</i>	96173
<i>T10000 Tape Drive Service Manual</i>	96175
<i>T10000 Virtual Operator's Panel User's Guide (for Service Representatives)</i>	96180
<i>T9840 Tape Drive User's Reference Manual</i>	95739
<i>T9x40 Tape Drive Installation Manual</i>	95879
<i>T9x40 Tape Drive Service Reference Manual</i>	95740
<i>Seagate Ultrium Tape Drive Product Manual</i>	CD included with drive
<i>Super DLT600 Product Manual</i>	CD included with drive
<i>T9840 Tape Drive User's Reference Manual</i>	95739
<i>T9940 Tape Drive Operator's Guide</i>	95989

<b>Tape Management Software Publications</b>	<b>Part Number</b>
--	--------------------

**Automated Cartridge System Library Software (ACSLS)**

<i>ACSLS Administrator's Guide</i>	3161201xx
<i>ACSLS Messages</i>	3161202xx
<i>ACSLS Quick Reference</i>	3161204xx

**Host Software Component (HSC) MVS Publications**

<i>HSC Configuration Guide</i>	3126422xx
<i>HSC Messages and Codes Guide</i>	3126425xx
<i>HSC Operator's Guide</i>	3126423xx
<i>HSC Reference Summary Guide</i>	3126426xx
<i>HSC System Programmer's Guide</i>	3126424xx

<b>Other Publications</b>	<b>Part Number</b>
---------------------------	--------------------

<i>Product Regulatory and Safety Compliance Manual</i>	3161956xx
<i>American National Standard Dictionary for Information Processing Systems</i>	ANSI X3/TR-1-82
<i>American National Standard Magnetic Tape and Cartridge for Information Interchange</i>	ANSI X3B5/87-009
<i>Magnetic Tape Labels and File Structure for Information Interchange</i>	ANSI X3.27-1978
<i>SCSI-3 Parallel Interface (SPI)</i>	ANSI X3T9.2/91-010R7
<i>Small Computer System Interface</i>	ISO 9316:1989
<i>Fibre Optics User's Guide</i>	9433

---

# Documentation, Support, and Training

---

Sun Function	URL	Description
Documentation	<a href="http://www.sun.com/documentation/">http://www.sun.com/documentation/</a>	Download PDF and HTML documents, and order printed documents
Support and Training	<a href="http://www.sun.com/supporttraining/">http://www.sun.com/supporttraining/</a>	Obtain technical support, download patches, and learn about Sun courses

---

---

## Third-Party Web Sites

Sun is not responsible for the availability of third-party web sites mentioned in this document. Sun does not endorse and is not responsible or liable for any content, advertising, products, or other materials that are available on or through such sites or resources. Sun will not be responsible or liable for any actual or alleged damage or loss caused by or in connection with the use of or reliance on any such content, goods, or services that are available on or through such sites or resources.

---

## Sun Welcomes Your Comments

Sun welcomes your comments and suggestions. You can submit your comments by going to:

<http://docs.sun.com>

Please include the title and part number of your document with your feedback:

*SL3000 User's Guide*, part number 316194401



## SL3000 Introduction

---

The SL3000 is the latest addition to the Sun StorageTek modular library family, which includes the SL500 and SL8500 modular library systems.

FIGURE 1-1 SL3000 Modular Library System



This chapter introduces you to the SL3000 library and its components and configurations, including the following topics:

- [“SL3000 Features” on page 2](#)
- [“Modular Design” on page 3](#)
- [“Base Module” on page 7](#)
- [“Drive Expansion Module” on page 10](#)
- [“Cartridge Expansion Module” on page 13](#)
- [“Parking Expansion Module” on page 14](#)
- [“Access Expansion Module” on page 15](#)
- [“Tape Drives” on page 17](#)
- [“Cartridge Access Ports” on page 19](#)
- [“Robotics Units” on page 20](#)
- [“Power Options” on page 22](#)
- [“Cooling” on page 23](#)
- [“Interfaces” on page 24](#)
- [“Library Management Software” on page 28](#)
- [“Operating Modes” on page 30](#)

## SL3000 Features

The SL3000 library offers customers the benefits of:

- Scalability in storage capacity from 200 to 5821 storage cells
- Performance from 1 to 56 tape drives
- Support of a variety of tape drives
- Any cartridge, Any slot™ support of mixed-media
- Heterogeneous attachments using standard interfaces
- Multiple library management software options and programs

The SL3000 was designed to:

- Address medium to large open systems and entry-level mainframe markets.
- Occupy a standard datacenter footprint with measurements of approximately:
  - Height: 198 cm (78 in.),
  - Depth: 124 cm (48.8 in.),
  - Length: varies from 91.5 cm (36 in.) with one module, to 478 cm (188 in.) with six modules

---

# Modular Design

The SL3000 library provides a modular design, which allows customers to meet the demands of a rapidly growing and constantly changing environment.

## Modules

There are five types of modules in an SL3000 library. The Base Module is the only one that is required.

- **Base Module** – one only
- **Drive Expansion Module (DEM)** – one only, attached directly to the left side of the Base Module
- **Cartridge Expansion Module (CEM)** – up to eight total, with up to four on the left side of the Base Module (and optional DEM) and up to four on the right
- **Parking Expansion Module (PEM)** – installed always in pairs, one on each end of the library configuration
- **Access Expansion Module (AEM)** – one or two, always installed on the end of the library configuration.

---

**Note** – AEMs and PEMs cannot be installed in the same library.

---

The modules consist of walls, columns, and rows that house cartridge storage cells, tape drives, cartridge access ports (CAPs), and robotics units (TallBots).

## CenterLine Technology

The SL3000 modular design uses CenterLine technology to help balance the work load and improve the performance of the library. The left side of the Base Module serves as the centerline. You can add other modules to the left and right of the Base Module. Columns to the right of the centerline have positive (+) numbers, while columns to the left have negative (-) numbers.

**FIGURE 1-2 on page 4** shows the library centerline and some possible module configurations, including:

- Base module only
- Base module and drive expansion module (DEM)
- Addition of cartridge expansion modules (CEMs) and parking expansion modules (PEMs) s

FIGURE 1-2 Library Configurations Around CenterLine

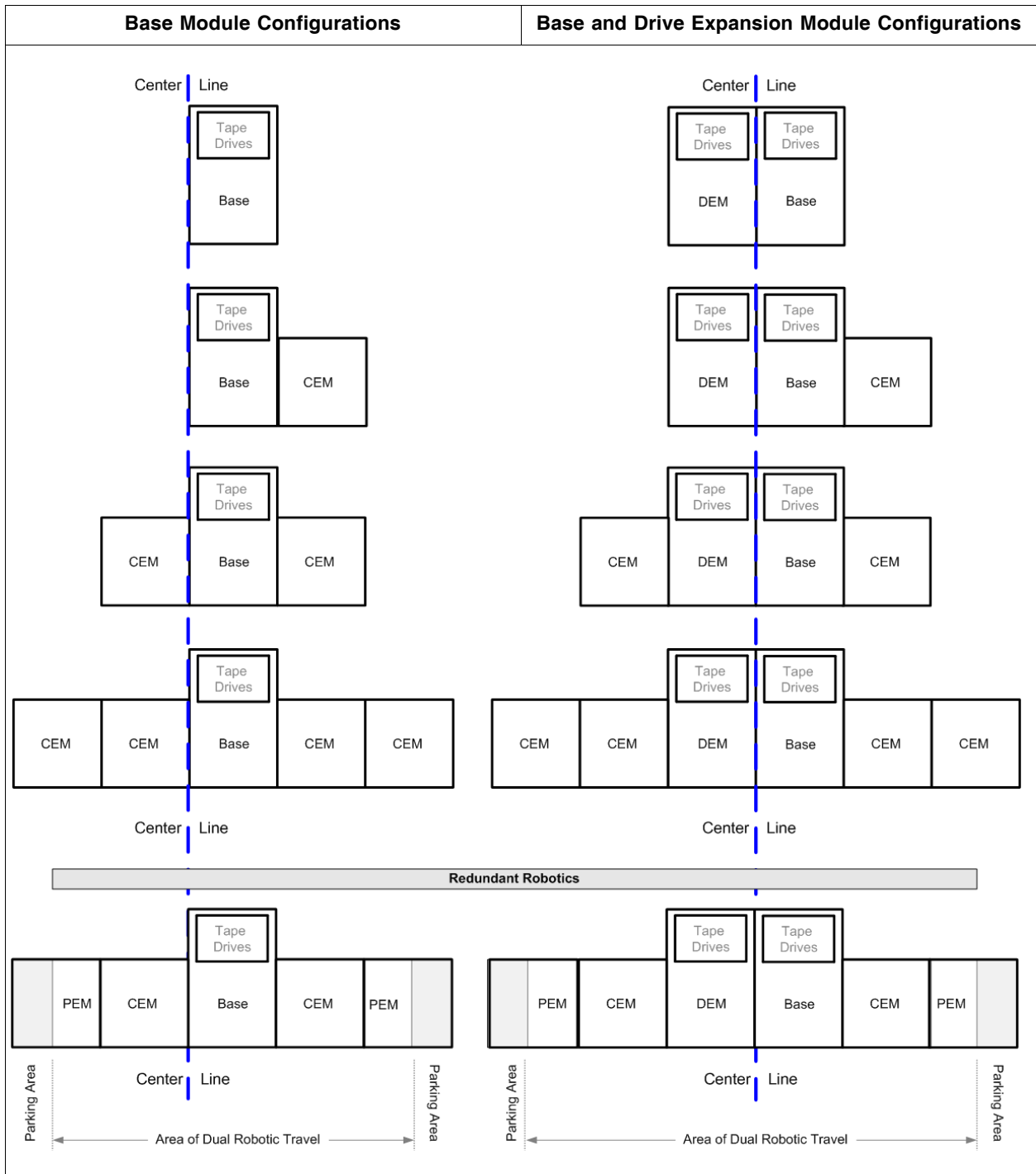



## Any cartridge, Any slot™ Technology

Mixed-media storage cells are used to hold the cartridges. This allows the SL3000 library to support the Sun StorageTek Any cartridge, Any slot technology and accept a variety of media types without reconfiguring the library.

Cartridges lie flat and are placed in the storage cells with hub down and parallel to the floor. To prevent slippage, cartridges are held in place by internal retainer clips.

## Physical Capacities

The SL3000 is scalable, with physical storage capacities from 200 to 5821 storage cells. In addition, the Capacity on Demand feature allows you to pay for only the capacity you actually use and expand capacity with minimal disruption to library operations.

See [Chapter 5, “Capacity on Demand” on page 223](#) for details about installing and managing library storage capacity.

See [TABLE 1-1 on page 6](#) for detailed physical capacities for each module type. To calculate the total accessible physical storage cells for a configuration, start with the standard configuration cell count, outlined with a heavy border, and then make the appropriate adjustments for options and positioning. Following are some examples:

- Base Module with operator’s panel, a module installed on the right, and three total drive arrays:
 
$$320 + 0 + 13 - 55 - 60 = 218$$
- DEM, a module installed on the left, window arrays, a CAP, and four drive arrays:
 
$$410 + 88 + 23 - 77 - 66 - 72 - 78 = 228$$
- CEM installed to the left of CenterLine, a module installed on the left, and a CAP:
 
$$516 + 104 - 78 = 542$$
- PEMs (always installed in pairs), one with a CAP, one without:
 
$$308 + 312 - 78 = 542$$

## Optional Fire/Smoke Detection

Access ports in the ceilings of the modules are provided for optional fire suppression or smoke detection equipment. Installation and maintenance of this equipment must be arranged by the customer.

TABLE 1-1 Accessible Physical Cell Count Per Module

Module Options	Standalone or Position-Independent	Adjacent Module Installed on the:		Total Count
		Right	Left	
<b>Base Module</b>				
Standard (with viewing window), standalone	320	+13	+88	
With operator's panel	+0			
With window storage arrays		+23		
With second drive array	-55		-66	
With third drive array	-60		-72	
<b>Drive Expansion Module (DEM)</b>				
Standard (with viewing window and no CAP)	—	410	+88	
With window storage arrays	—	+23		
With CAP	—	-77		
With second drive array	—	-55	-66	
With third drive array	—	-60	-72	
With fourth drive array	—	-65	-78	
<b>Cartridge Expansion Module (CEM)</b>				
Standard (no CAP), to the left of CenterLine	516	+0	+104	
Standard (no CAP), to the right of CenterLine	620	+0	+0	
With CAP		-78		
<b>Parking Expansion Module (PEM)</b>				
Standard (no CAP), to the left of CenterLine	308			
Standard (no CAP), to the right of CenterLine	312			
With CAP	-78			
<b>Access Expansion Module (AEM)</b>				
Cannot be used for long-term storage	0			
<b>Total accessible storage cell count</b>				

## Base Module

The Base Module provides both cartridge storage and a minimum of eight tape drives. This module includes the power configurations, robotics, electronic modules, cartridge access port, cartridge storage cells, tape drives, and operator controls. It centralizes the infrastructure for all other modules in the library.

One and only one Base Module is required for every library installation.

FIGURE 1-3 Base Module – Front View

	<b>Configurations</b>		<b>Capacity</b>
	8 drives 16 drives 24 drives		See <a href="#">TABLE 1-1</a> on page 6
	8 drives, CAP 16 drives, CAP 24 drives, CAP		
	8 drives, CAP, and Operator panel/Window 16 drives, CAP, and Operator panel/Window 24 drives, CAP, and Operator panel/Window		
<b>Dimensions</b>		<b>Measurement</b>	
Height		197 cm (77.625 in.) to 200 cm (78.63 in.) fully adjusted	
Width		76.76 cm (30.22 in.) without covers <sup>1</sup> 91.5 cm (36 in.) with covers	
Depth		121.9 cm (48 in.) without handles 124 cm (49 in.) with handles	
Weight		265 kg (584 lb) frame only	
Service clearance		Front: 46 cm (18 in.) Rear: 81 cm (32 in.)	
Both doors open		262 cm (103 inches)	
Side clearance <sup>2</sup>		Cooling: 5 cm (2 in.) Installation: 91 cm (36 in.)	
<b>Notes:</b>			
1. When additional modules are installed, the covers are removed from the Base Module and replaced on the ends of the last module in the string.			
2. Required to install or remove the sides covers; they swing out and lift off of brackets.			

The front of the Base Module includes the following components:

- Single, 26-cartridge, dual-magazine cartridge access port (CAP)
- Service door for library access
- Front panel with three LEDs: Library Active, Service Required, and Wait.
- Standard viewing window, which can be replaced by either of the following options:
  - Touch-screen operator panel
  - Cartridge storage cells

The Base Module can hold up to 24 tape drives in any combination that the library supports – see [“Tape Drives” on page 17](#) for a list and description. The minimum configuration includes one drive bay that can hold from one to eight drives. Two additional drive bays can be added to accommodate either 8 or 16 more drives, for a maximum of 24 drives.

---

**Note** – Adding a drive bay displaces approximately 55 to 72 additional storage cells, depending on the library configuration. See [TABLE 1-1 on page 6](#) for the exact number.

---

See [FIGURE 1-4 on page 9](#) for a rear view of the Base Module. The rear door allows access to the following:

- Electronics control module (ECM)
- Power distribution units (PDUs)
- DC power supplies
- Tape drives
- Two one-unit rack spaces (1 unit = 44.5 mm [1.75 in.]) for vertically mounting auxiliary equipment, such as Ethernet switches

---

**Note** – The Base Module does not contain any general-purpose 19-inch rack space.

---

See [FIGURE B-1, “Base Module Walls” on page 510](#) for a detailed diagram of the wall layout.

FIGURE 1-4 Base Module – Rear View Drawing

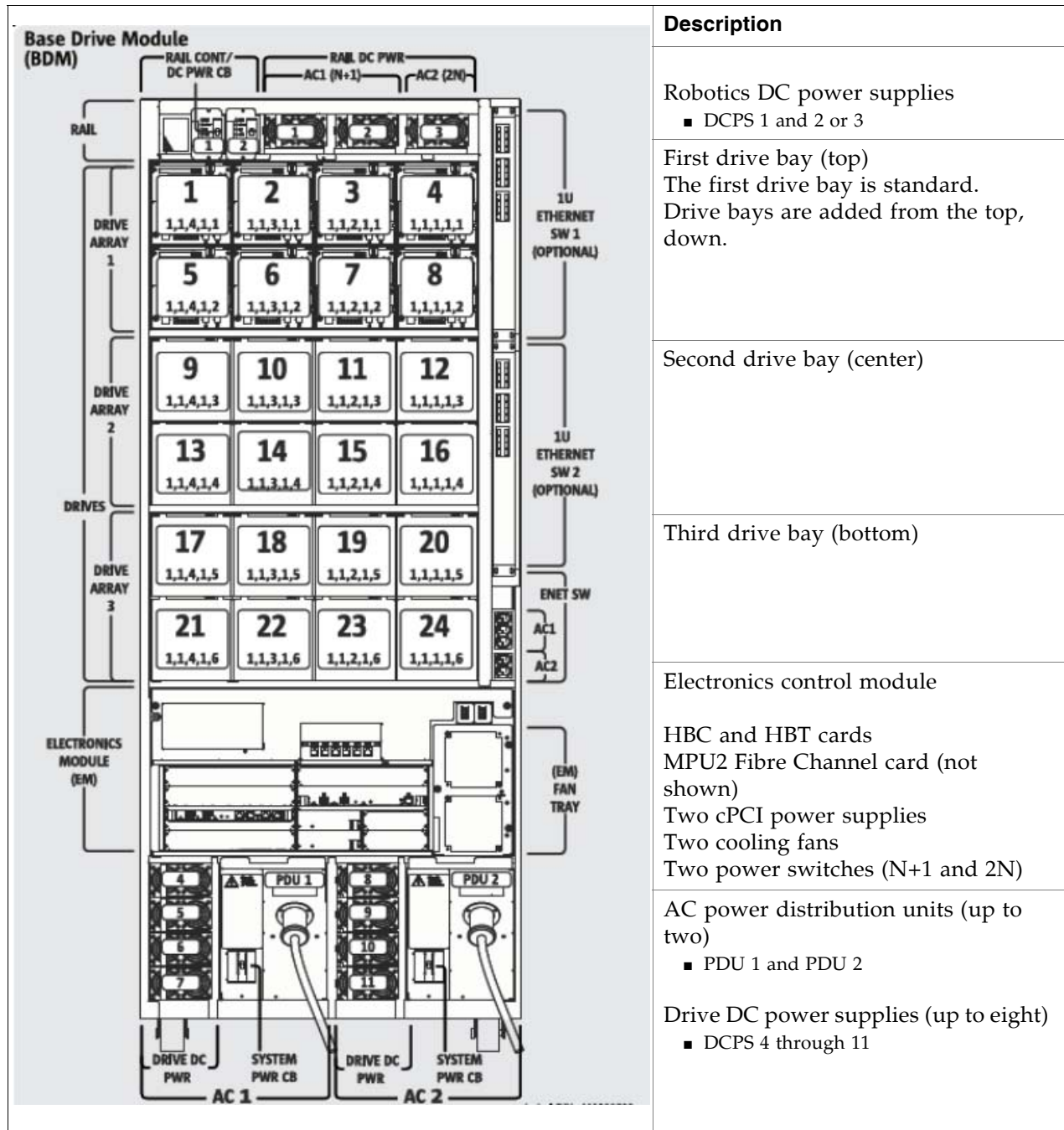

Description
Robotics DC power supplies <ul style="list-style-type: none"> <li>■ DCPS 1 and 2 or 3</li> </ul>
First drive bay (top) The first drive bay is standard. Drive bays are added from the top, down.
Second drive bay (center)
Third drive bay (bottom)
Electronics control module  HBC and HBT cards MPU2 Fibre Channel card (not shown) Two cPCI power supplies Two cooling fans Two power switches (N+1 and 2N)
AC power distribution units (up to two) <ul style="list-style-type: none"> <li>■ PDU 1 and PDU 2</li> </ul>
Drive DC power supplies (up to eight) <ul style="list-style-type: none"> <li>■ DCPS 4 through 11</li> </ul>

# Drive Expansion Module

The optional Drive Expansion Module (DEM) provides the library with additional tape drives and cartridge storage capacity. One DEM can be included in a library installation, always to the left of the Base Module.

FIGURE 1-5 Drive Expansion Module – Front View

	<b>Configurations</b>		<b>Capacity</b>	
	8 drives 16 drives 24 drives 32 drives		See <a href="#">TABLE 1-1</a> on page 6	
	8 drives, CAP 16 drives, CAP 24 drives, CAP 32 drives, CAP			
	8 drives, CAP, and Operator panel/Window 16 drives, CAP, and Operator panel/Window 24 drives, CAP, and Operator panel/Window 32 drives, CAP, and Operator panel/Window			
	<b>Dimensions<sup>1</sup></b>	<b>Measurement</b>		
	Height	197 cm (77.625 in.) to 200 cm (78.63 in.)		
	Width DEM only Base and DEM	76.76 cm (30.22 in.) 168.2 cm (66.22 in.) with covers <sup>2</sup>		
	Depth	121.9 cm (48 in.) without handles 124 cm (49 in.) with handles		
	Weight	265 kg (584 lb) frame only		
	Service clearance Both doors open	Front: 46 cm (18 in.) Rear: 81 cm (32 in.) 262 cm (103 inches)		
Side clearance <sup>3</sup>	Cooling: 5 cm (2 in.) Installation: 91 cm (36 in.)			
<b>Notes:</b>				
1. The dimensions of the DEM are the same as the Base module.				
2. When additional modules are installed, the covers are removed from the Base Module and replaced on the ends of the last module in the string.				
3. Required to install or remove the side covers; they swing out and lift off of brackets.				

The front of the DEM includes space for the following components:

- Service door for library access (standard)
- Front panel with three LEDs: Library Active, Service Required, and Wait
- Optional 26-cartridge, dual-magazine cartridge access port (CAP)
- Standard viewing window, which can be replaced by either of the following options:
  - Touch-screen operator panel, if not already in the Base Module
  - Cartridge storage cells

The DEM comes standard with drive slots to support up to eight tape drives. DEM drive slots can optionally be increased, in increments of eight, to a maximum of 32.

---

**Note** – Adding a drive bay displaces approximately 55 to 78 additional storage cells, depending on the library configuration. See [TABLE 1-1 on page 6](#) for the exact number.

---

There is an additional power system integral to the DEM to support the additional tape drives.

See [FIGURE 1-6 on page 12](#) for a rear view of the DEM. The rear door allows access to the following:

- Tape drives
- Drive DC power supplies
- AC power distribution units (PDUs)

See [FIGURE B-2, “Drive Expansion Module Walls” on page 511](#) for a detailed diagram of the wall layout.

FIGURE 1-6 Drive Expansion Module – Rear View Drawing

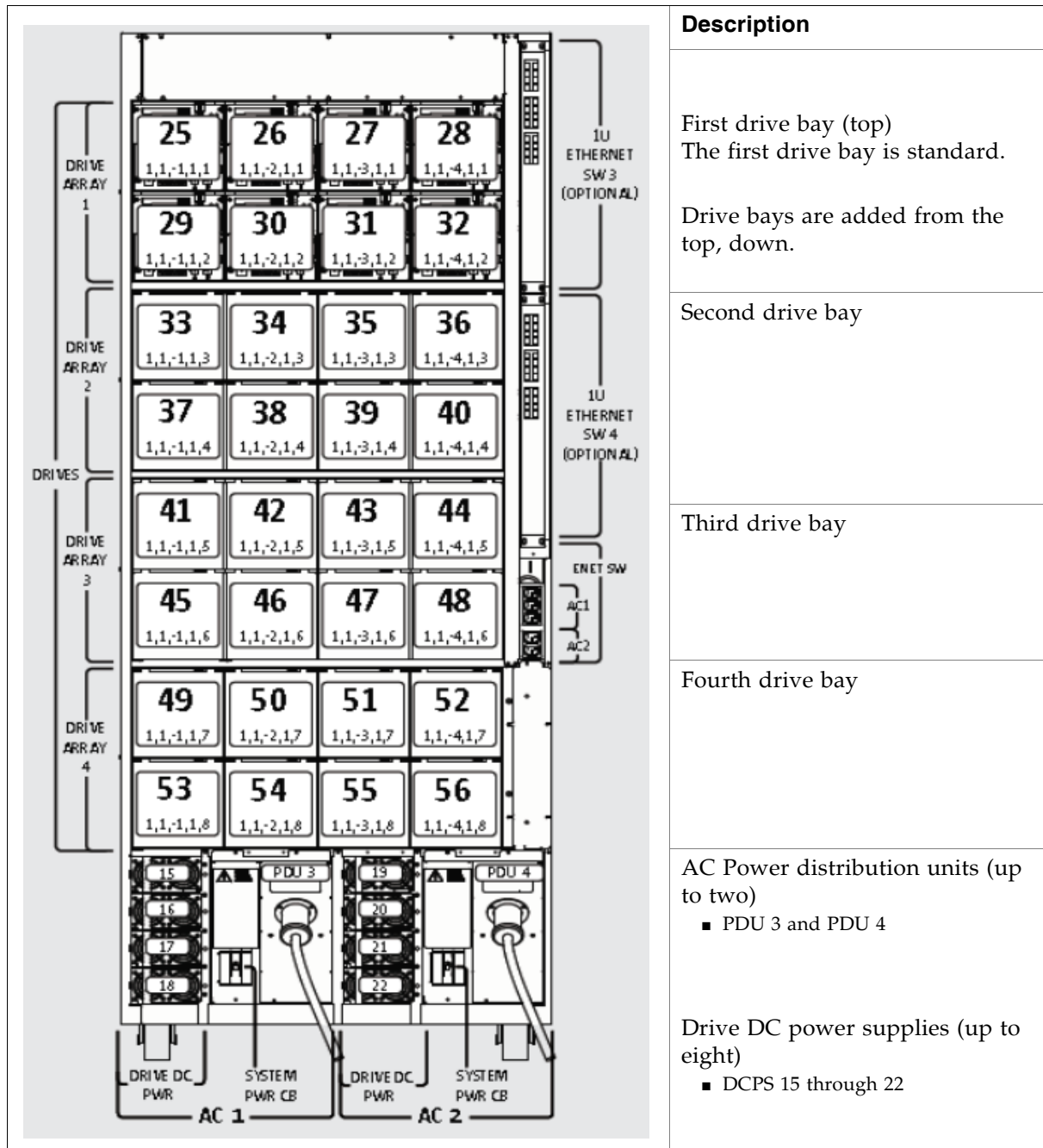

Description	
First drive bay (top) The first drive bay is standard.	
Drive bays are added from the top, down.	
Second drive bay	
Third drive bay	
Fourth drive bay	
AC Power distribution units (up to two) <ul style="list-style-type: none"> <li>■ PDU 3 and PDU 4</li> </ul>	
Drive DC power supplies (up to eight) <ul style="list-style-type: none"> <li>■ DCPS 15 through 22</li> </ul>	



# Cartridge Expansion Module

The optional Cartridge Expansion Module (CEM) provides additional storage cell capacity and growth. No tape drives are in this module. A maximum of eight CEMs are supported in a single library.

The following considerations will maximize library efficiency:

- As a best practice, CEMs should be alternated on either side of the Base Module and optional DEM, with the initial CEM installed directly to the right of the Base Module. This decreases the amount of robotics travel and provides the best use of cartridge storage cells.
- If redundant TallBots are installed, the two outside CEMs are converted to parking extension modules (PEMs). This provides areas for the TallBots to get out of the way of one another.

Each CEM adds up to 620 data cartridge physical storage cells. The capacity varies depending on the direction of growth (left or right) and the presence of a CAP.

FIGURE 1-7 Cartridge Expansion Module with Base Module

	<b>Configuration</b>		<b>Capacity</b>
	(next to Base with 24 drives)		
	CEM (expanded left) CEM with optional CAP (left)	See <a href="#">TABLE 1-1</a> on page 6	
	CEM (expanded right) CEM with optional CAP (right)		
	<b>Dimensions</b>	<b>Measurement</b>	
	Height	197 cm (77.625 in.) to 200 cm (78.63 in.) fully adjusted	
	Width	76.75 cm (30.22 in.) without covers <sup>1</sup> Cover adds 7.62 cm (3 in.)	
	Depth	80 cm (31.5 in.)	
	Weight	175 kg (385 lb) frame only	
	Side clearance <sup>2</sup>	Cooling: 5 cm (2 in.) Installation: 91 cm (36 in.)	
Service clearance, front and rear	None required		
<b>Notes:</b>			
1. When additional modules are installed, the covers are removed from the Base Module and replaced on the ends of the last module in the string.			
2. Required to install or remove the sides covers; they swing out and lift off of brackets.			

See [FIGURE B-3, "Cartridge Expansion Module Walls"](#) on page 512 for a detailed diagram of the wall layout.

# Parking Expansion Module

The optional Parking Expansion Modules (PEMs) provide additional storage cell capacity and growth, as well as space for defective TallBots to be “parked” for service. The parking space makes the three outer-most columns of storage cells on the front and rear walls inaccessible. The inaccessible cells can be left out of the module, or they can be installed to allow later conversion of the PEM to a CEM. PEMs do not include tape drives.

PEMs are only used with redundant TallBots, and they are always installed in pairs. They must be the last modules on the right and left sides of the library string.

---

**Note** – AEMs and PEMs cannot be installed in the same library.

---

FIGURE 1-8 Parking Expansion Module

	<b>Configuration</b>		<b>Capacity</b>
	PEM (expanded left) 308 cells PEM (expanded right) 312 cells CAP –78 cells Installed in pairs for the redundant TallBot feature.		See <a href="#">TABLE 1-1 on page 6</a>
	<b>Dimensions<sup>1</sup></b>	<b>Measurement</b>	
	Height:	197 cm (77.625 in.) to 200 cm (78.63 in.) fully adjusted	
	Width:	76.75 cm (30.22 in.) without covers 77.5 cm (30.5 in.) with covers <sup>2</sup>	
	Depth:	80 cm (31.5 in.)	
	Weight:	103.4 kg (277 lb) frame only	
	Side clearance	Cooling: 5 cm (2 in.) Installation: 91 cm (36 in.) <sup>3</sup>	
	Service clearance front and rear	None required	
	<b>Notes:</b> 1. The dimensions of the PEM are the same as the cartridge expansion module. 2. When additional modules are installed, the covers are removed from the Base Module and replaced on the ends of the last module in the string. 3. Required to install or remove the sides covers; they swing out and lift off of brackets.		

See [FIGURE B-4, “Parking Expansion Module Walls” on page 513](#) for a detailed diagram of the wall layout.

---

# Access Expansion Module

The optional Access Expansion Module (AEM) provides the following capabilities:

- Bulk loading and unloading of up to 234 cartridges at a time to and from the SL3000 library through the AEM CAP. The AEM is essentially a very large CAP, with all the characteristics of a CAP, such as online/offline state, ability to be shared by partitions, etc. The cartridge slots in the AEM cannot be used for long-term cartridge storage.
- Non-disruptive robot maintenance through the use of a safety door (or “garage” door), which sections off a defective robot from the other library modules. A Sun service representative can safely access the disabled robot through the AEM access door while the library remains online. If redundant robots are installed, the library can continue normal operations through the remaining functional robot.

The library can include one or two AEMs. The AEM must be installed at the very end of the library string. If the library includes redundant robots, then two AEMs must be installed, one on each end of the library.

---

**Note** – AEMs and PEMs cannot be installed in the same library.

---

AEMs do not include tape drives.

See [“AEM Operations” on page 84](#) for additional details about AEM functions and usage.

FIGURE 1-9 Access Expansion Module

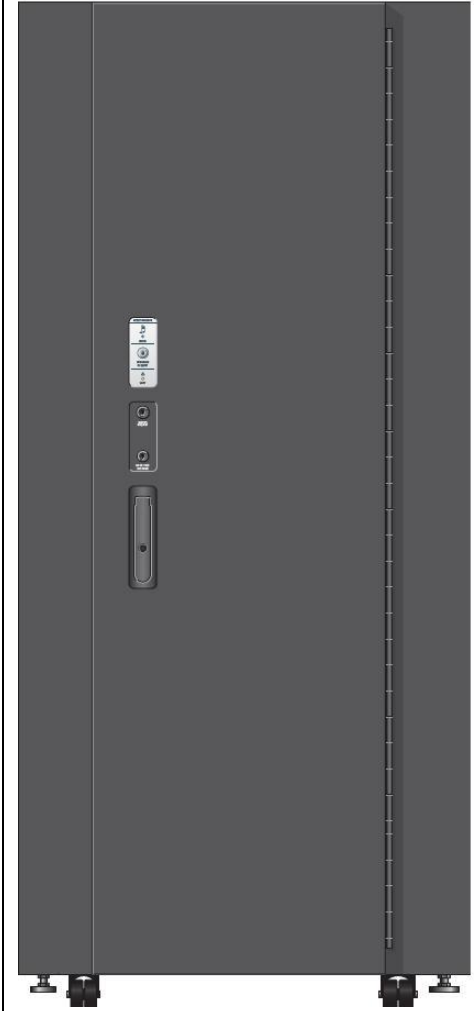
	<b>Configuration</b>		<b>Capacity</b>
	AEM (expanded left) 234 CAP cells AEM (expanded right) 234 CAP cells Installed in pairs for the redundant TallBot feature.		See <a href="#">TABLE 1-1 on page 6</a>
	<b>Dimensions</b>	<b>Measurement</b>	
	Height:	197 cm (77.625 in.) to 200 cm (78.63 in.) fully adjusted	
	Width:	91.5 cm (36.0 in.) without covers 96.5 cm (38.0 in.) with covers <sup>1</sup>	
	Depth:	80 cm (31.5 in.)	
	Weight:	204.12 kg (450 lb.)	
	Side clearance	Cooling: 5 cm (2 in.) Installation: 91 cm (36 in.) <sup>2</sup>	
	Service clearance	Front: 58.7 cm (23.1 in.) Rear: Need access for Ethernet; there is no cover.	
	<b>Notes:</b>		
1. When additional modules are installed, the covers are removed from the Base Module and replaced on the ends of the last module in the string. 2. Required to install or remove the side covers; they swing out and lift off of brackets.			

# Tape Drives

See [TABLE 1-2](#) for the tape drives, data path interfaces, and media types supported by the SL3000 library.

TABLE 1-2 Supported Tape Drives

Vendor	Drive Type	Interface Type	Media
Sun StorageTek <sup>1</sup>	T9840C T9840D (encryption capable)	Fibre Channel FICON ESCON	9840 VolSafe capable
Sun StorageTek	T10000A, T10000B (encryption capable)	2 Gb/4 Gb Fibre Channel FICON	T10000 Standard, Sport, and VolSafe
HP	LTO 3 LTO 4 (encryption capable)	Fibre Channel	LTO 3 LTO 4 WORM (LT) LTO 2 (read-only) <sup>4</sup>
IBM	LTO 3 LTO 4	Fibre Channel	LTO 3 LTO 4 WORM (LT) LTO 2 (read-only) <sup>2</sup>
<b>Notes:</b>			
1. Sun StorageTek T9840 drives, models A & B, and T9940 drives, models A & B, are not supported.			
2. LTO 2 media is supported for backward compatibility of LTO products (data migration).			

You can install up to 56 drives within one library, as follows:

- Up to 24 in the Base Module
- Up to 32 in a DEM

The actual number of drives varies, depending on the AC power option and the media types. See [TABLE 1-3](#) for details.

TABLE 1-3 Power Options and Number of Drives

	110–127 PDU		220–240 PDU	
	Base Module	DEM	Base Module	DEM
T9840	12	14	24	32
T10000	13	16	24	32
LTO 3, 4	24	32	24	32
Mixed media	varies		any intermix	

## Drive Trays

In the SL3000, a single, universal drive tray accommodates all types of tape drives and interfaces. The SL3000 drive trays have two layers, as follows:

- The power supply and connections are on the top.
- The tape drive is under the power supply.

Each drive tray slides into an eight-drive bay.

FIGURE 1-10 Drive Tray

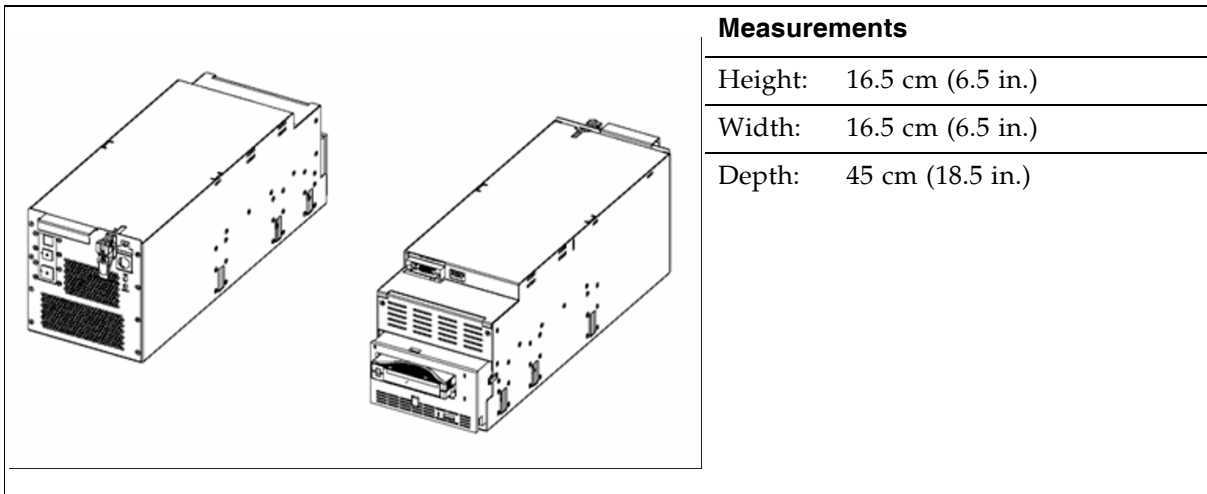

Internal power supply cards and cabling are unique, depending on the drive type and interface within the drive tray. Cabling to the drive itself is out of the rear of the drive tray and library, then routed through the strain relief system. Both floor and ceiling cabling access is allowed.

## Cartridge Access Ports

The cartridge access port (CAP) is a vertically-mounted, rotating cylinder with two removable 13-slot magazines (26 cells total). CAPs are used to enter or eject cartridges from the library.

The Base Module comes with one CAP as a standard feature. Optionally, one CAP can be installed in each expansion module, up to a maximum of ten CAPs for the library.

Each CAP has its own set of controls, consisting of a small keypad and indicators. The CAP and its magazines rotate as a single unit.

See [“CAP Operations” on page 79](#) for details about using CAPs.

FIGURE 1-11 Cartridge Access Port

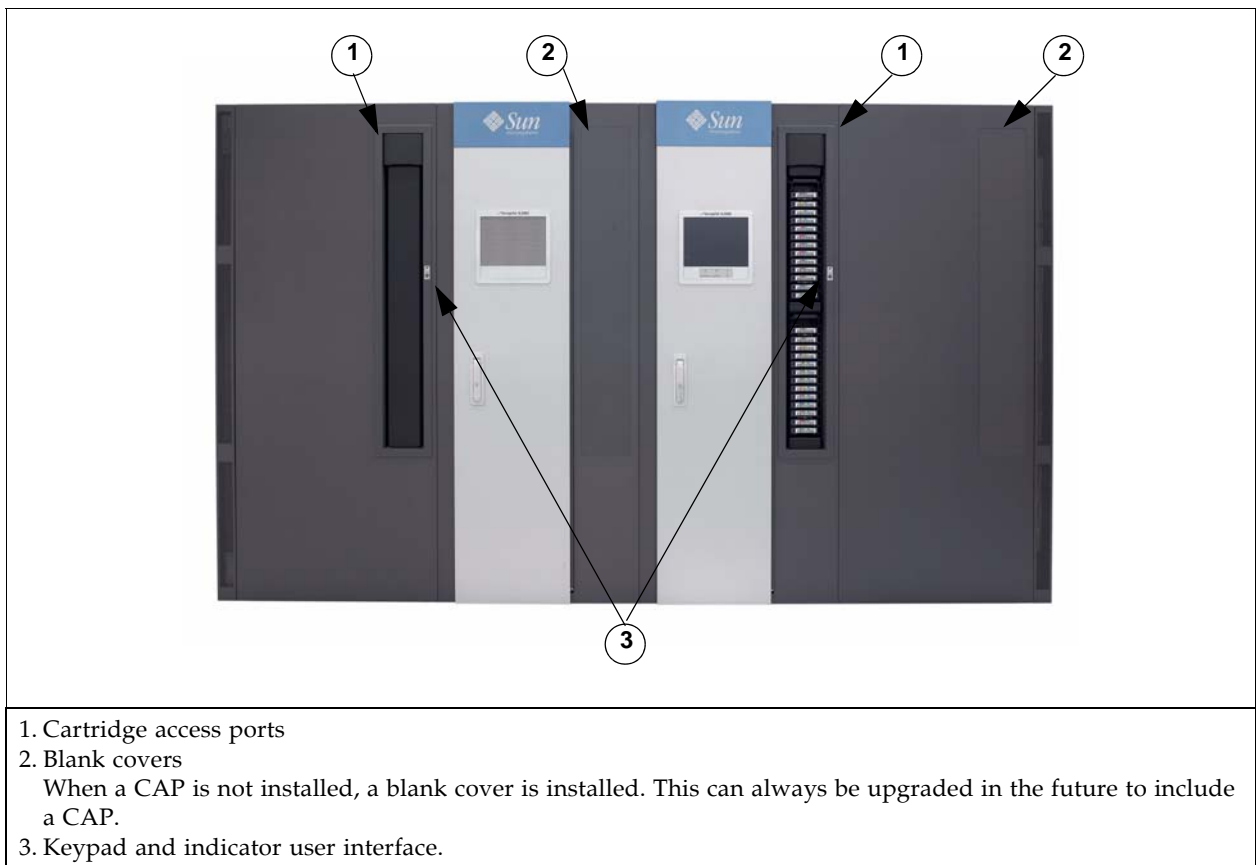

---

## Robotics Units

The robotics unit in an SL3000 library is called a TallBot. Each library can have either one (standard) or two (redundant) TallBots.

TallBots are responsible for the movement and cataloging – or audit – of cartridges throughout the library.

FIGURE 1-12 TallBot

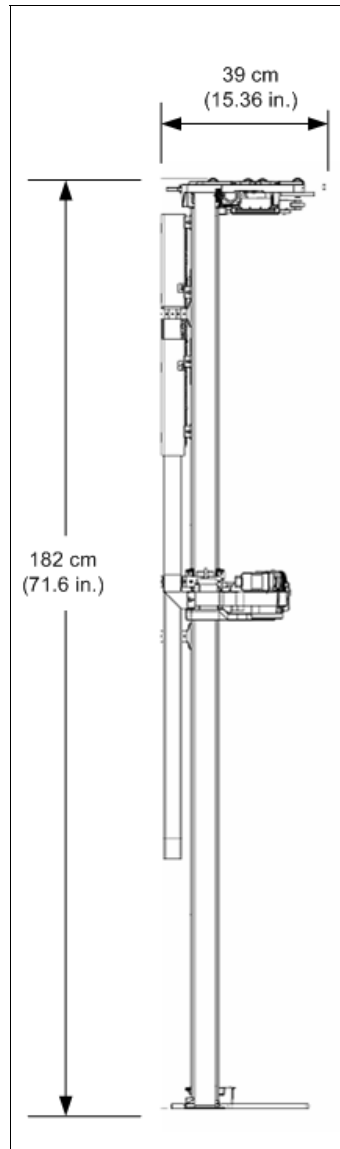

TallBot measurements are:

- Width: 30 cm (11.84 in.)
- Depth: 39 cm (15.36 in.)
- Weight: 8.6 kg (19 lb)



TallBots are driven along two rails on the rear wall of the library – one rail at the top and one attached to the floor.

Two copper strips are inserted into the top rail to provide both power and signal paths for TallBot operation.

- Power comes from +48 VDC, 1200 Watt, load-sharing power supplies.
- Signals are received and transmitted between the TallBots and the library controller.
- A Rail Power Enable module is installed as a safety circuit for rail power.

Handling of the cartridges by the TallBots include:

- Retrieving cartridges from a CAP
- Inserting cartridges into a CAP
- Inserting and retrieving cartridges to and from storage cells
- Mounts and dismounts of cartridges to and from tape drives

TallBots contain a laser bar code scanner that:

- Reads the configuration blocks in each module during library initialization. See [FIGURE B-6 “Configuration Block” on page 515](#) for an example.
- Targets on cartridge storage/CAP cells and tape drives. Targets have the following shape, similar to the letter “N”:

| \ |

- Identifies volume IDs (VOLIDs) of cartridges during:
  - CAP entries
  - Audits

The TallBot reads cartridge VOLIDs during audits and CAP enters only. Each cartridge’s assigned location is stored in the library controller database, and the TallBot uses that location to retrieve the cartridge.

## Redundant (Dual) TallBots

Redundant TallBots are offered as a high availability option. This affords:

- A speed increase for library operations
- A backup TallBot in case one should fail

This option requires PEMs at each end of the library. A defective TallBot will take itself offline and may move, or can be pushed, into one of the PEMs, allowing the library to continue operations with one TallBot until time can be scheduled to replace the defective TallBot.

The requirements for redundant TallBot operation are:

- A 240 VAC, 2N power configuration
- PEMs on each end of the library
- Dual TallBot license

# Power Options

## AC Power Configurations

The following AC power source options are available:

- Limited features: 110 VAC, 50/60 Hz, at 20 Amps (range: 100–127 VAC, 50–60 Hz, 16 Amps)
- Full features: 220 VAC, 50/60 Hz, at 30 Amps (range: 200–240 VAC, 50–60 Hz, 24 Amps)

Power Distribution Units (PDUs) are located at the rear of the Base Module and optional DEM.

## Power Redundancy

The SL3000 provides full redundancy for tape drives, robotics units, and electronics. The following redundancy options are available:

- N+1 – One AC PDU, with one extra DC power supply for DC power redundancy. This is the standard power configuration for the SL3000. This configuration requires at least a 20 Amp circuit breaker at the customer's branch service panel.
- 2N – Two PDUs for AC redundancy; each PDU has a set of DC power supplies (N DC power supplies). This configuration requires a second, separate customer power source.
- 2N+1 – Two PDUs for AC redundancy; each PDU has extra DC power supplies for N+1 redundancy for each PDU. The second PDU does not have N+1 for the TallBot.

## DC Power

Load sharing 1200 Watt DC power supplies are required for distribution of +48 VDC for TallBot and tape drive operation. The number of DC power supplies required depends on the power configuration and total number of drives in the library.

A Rail Power Enable module is also installed as a safety circuit for rail power. Two cPCI power supplies (200 Watts each) distribute power to the Electronics Control Module. These power supplies are located below the HBT card – two on the left for N+1, or one on each side for 2N.

---

# Cooling

Cooling within the SL3000 is divided into three areas:

- Library electronics
- Tape drives
- DC power supplies

## Library Electronics

There are two fans located to the right of the electronics control module that provide cooling for the electronics in the library. Air is drawn from the floor and sides of the library and flows through the fans to the rear of the library.

- These fans are monitored by the HBC card for proper operation.
- An amber Fault indicator is on the fan assembly to indicate a failure.

While there are two dedicated fans, one fan is sufficient to provide adequate cooling for the library/electronics. Nevertheless, since the fans can be replaced without interfering with library operations, it is best to replace a defective fan when it is detected.

## Tape Drives

Each tape drive tray contains one or two fans for drive cooling.

Power for the fans is supplied through the tape drives power converter card. Air is drawn from the front of the drive and flows through the fan to the rear of the drive/library.

## DC Power Supplies

Each 1200 Watt DC power supply contains a fan that pulls air from the front of the library, through the rear of the supply, and out the rear of the library.

---

# Interfaces

The SL3000 library supports the following types of interfaces:

- **Library Control Path** – Transfers library management commands, such as cartridge mounts and dismounts, between the host and the library components. No host data is present on this interface.
- **Data Path** – Transfers data between the host and the tape drives.
- **Command Line Interface** – Allows a Sun support representative to configure and diagnose the library.
- **SNMP** – Allows system administrators to query the library and receive information about potential problems.
- **SL Console** – Allows library operators and administrators to configure and manage the library from a graphical user interface.

## Library Control Path

---

**Note** – When a new library is integrated into a network, it is strongly recommended that the system/network administrator work closely with a Sun StorageTek representative to define the configuration.

---

The control path provides for the transfer of library management commands between the host and the library. The SL3000 supports the following host connection types for the control path:

- **TCP/IP Interface** – TCP/IP protocol using Ethernet 10/100 Base-T and CAT-5 cables
- **FC-SCSI Interface** – Small Computer System Interface (SCSI) protocol and command set over a physical Fibre Channel interface

A non-partitioned library can use only one interface type – either FC-SCSI or TCP/IP. Using the optional Partitioning feature, a library can connect to multiple hosts over a combination of the two interface types. See [Chapter 6, “Library Partitioning” on page 267](#) for details.

Library addressing depends on the host connection type:

- TCP/IP hosts use a panel, row, column (PRC) numbering scheme.
- FC-SCSI hosts use a sequential element numbering scheme, with each element type (storage cells, tape drives, and CAPs) having its own sequential range.

See [Appendix A, “Library Resource Addresses” on page 491](#) for full details.

## TCP/IP Interface

The TCP/IP interface type uses the TCP/IP protocol over an Ethernet physical interface, (CAT-5, Ethernet, 10/100 BaseT cable). This interface enables either of the following host platforms to connect to and communicate with the library:

- Open system platforms with ACSLS (see [“Automated Cartridge System Library Software \(ACSLs\)” on page 29](#) for details).

- Enterprise-level mainframes with HSC (see [“Host Software Component”](#) on page 28 for details).

The library controller coordinates all component operations within the library and provides the interface connection with the host.

### *Connections*

There are two separate Ethernet connections on the library controller card for host-to-library communications.

- Port 2A provides the Dual TCP/IP connection – this is an optional, licensed feature that provides built-in redundancy.
- Port 2B provides the primary host connection – this is the standard connection for SL3000 libraries.

Both ports comply with the Institute of Electrical and Electronics Engineers standard—IEEE 802.3—for Ethernet networks. Both ports are capable of auto-negotiating the following functions:

- Method of transmission
  - Half-duplex: Transmits data in just one direction at a time
  - Full-duplex: Transmits data in two directions simultaneously
- Speed of the transmission
  - 10Base-T: 10 megabits per second (Mbps)
  - 100Base-T: 100 megabits per second (Mbps)

### *Network*

Because the SL3000 is installed on a network, it is preferable that library activity be isolated from regular network traffic. Therefore, the following distinct networks are present:

- Public network – handling all customer-attached networking for the public system controller ports, such as:
  - Internet access
  - Library-to-host commands
- Private network – handling all internal library networking for the private system controller ports, such as:
  - CAPs
  - Drive control path
  - Local operator panel

---

**Note** – A private network connection between the library and host management software, using an Ethernet hub or switch, is recommended for maximum throughput and minimum resource contention.

---

If a shared network is required, these actions can help with the communication between the host and the library:

- Directly connect the library to a switch.
- Place the library on its own subnet.

- Use a managed switch that can:
  - Set priorities on ports to give the host and library higher priority.
  - Provide dedicated bandwidth between the host and the library.
  - Create a VLAN between the host and the library.
- Use a virtual private network (VPN) to insulate host-to-library traffic.

Sun StorageTek's 9300 Control Path Adapter provides the hardware connection for mainframe hosts. This interface adapter is installed on the mainframe and converts data on the Ethernet network to compatible Host Library Interface (HLI) commands.

## FC-SCSI Interface

The FC-SCSI interface type uses the SCSI command set over a physical Fibre Channel connection. The Sun StorageTek implementation of Fibre Channel conforms to the following standards:

- American National Standards Institute (ANSI)
- National Committee for Information Technology Standards (NCITS)

Applications supporting the SCSI-3 protocol are required for FC-SCSI hosts.

The recommended Fibre Channel topology for the SL3000 is switched fabric. A switched fabric provides dynamic interconnections between nodes, and multiple, simultaneous Fibre Channel connections for the network.

If the SL3000 is connected to a Fibre Channel switch or fabric-capable host, it automatically configures itself as a switched topology and can support up to 16 million ports logged into the fabric.

See the *SL3000 Interface Reference Manual* (PN 3161952xx) for complete information. This manual contains information about the SCSI command set, plus information about Fibre Channel operations, command implementations, topologies, cables, and connectors.

---

**Note** – While the SL3000 supports the arbitrated loop topology, this topology is not recommended.

---



---

**Note** – The SL3000 does not support forcing arbitrated loop connection by setting Hard ALPAs (Arbitrated Loop Physical Addresses).

---

## Data Path

The data path, which is separate and distinct from the library control path supports the transfer of data between the host and the tape drive. Host data paths to the tape drives can be Fibre Channel, FICON, or ESCON, depending on the operational characteristics of the drive type. See ["Tape Drives" on page 17](#) for details.

## Command Line Interface

The SL3000 command line interface (CLI) is a library interface for trained and qualified Sun support representatives only. This interface allows support representative to configure and diagnose problems with the library.

---

**Note** – Customers do not have access to the CLI interface.

---

## SNMP

Simple Network Management Protocol (SNMP) allows system administrators and network managers to monitor and receive library status information, including the following:

- Operational state of the library (such as microcode level, serial number, online/offline status)
- Status of the CAPs (such as open, closed, number of cells)
- Library elements (number of TallBots, storage cells, CAPs)
- Number of storage cells and media types in the library
- Number and types of tape drives installed in the library

---

**Note** – By default, the SNMP agent is turned off and must be activated by your Sun support representative through the command line interface (CLI).

---

The SL3000 supports the following SNMP versions:

- SNMPv2c – For machine status queries; the information transmitted is not secure.
- SNMPv3 – For Sun Confidential: Internal Use Only information, since it supports encryption and strong user identification. SNMPv3, therefore, is the preferred protocol for proprietary data.

---

**Note** – See the *SL3000 SNMP Guide* (PN 3161945xx) for detailed information concerning SNMP and the setup procedures.

---

## SL Console

The StorageTek Library Console (SL Console) is a Java-based software application that provides a graphical user interface (GUI) for monitoring and managing the StorageTek SL3000 library. See [Chapter 2, “StorageTek Library Console” on page 33](#) for complete details.

# Library Management Software

Library management software components control the library to perform activities such as mounts and dismounts, enters and ejects. They also manage their own cartridge databases, containing volume location and attribute information.

Sun offers several software components depending on the platform, connection type, and operating system. These include the following:

- ACSLS
- HSC (MVS) – using a TCP/IP interface only
- Direct-attach SCSI – using a Fibre Channel interface only
- ExLM
- ExHPDM
- ExPR
- VSM
- VTL

---

**Note** – See the appropriate library management software documentation for the version levels required to support the SL3000.

---

---

**Note** – LibraryStation is not supported for the SL3000.

---

## Nearline Control Solutions

The SL3000 supports the following Sun Nearline Control Solutions (NCS) software products.

- [Host Software Component](#)
- [Storage Management Component](#)
- [Sun StorageTek HTTP Server](#)

### Host Software Component

When an SL3000 library is connected to an MVS host, the host must run a version of Sun StorageTek's Host Software Component (HSC) along with the Storage Management Component (SMC).

Together, Sun StorageTek's HSC and SMC perform the following functions:

- Influence allocations
- Intercept mount and dismount messages
- Receive host requests and translate them into library control commands

HSC resides within the MVS host, but is invisible to the actual operating system.



## Storage Management Component

Storage Management Component (SMC) is the interface between IBM's OS/390 and z/OS operating systems and a Sun StorageTek library. SMC performs the allocation processing, message handling, and SMS processing for the NCS solution. SMC resides on the MVS host system with HSC, or on a remote system using the Sun StorageTek HTTP server to communicate with the HSC. SMC communicates with HSC to determine policies, volume locations, and drive ownership.

---

**Note** – SMC is a required NCS component.

---

## Sun StorageTek HTTP Server

Sun StorageTek's HTTP Server for OS/390 and z/OS optionally provides the middleware to allow communication between the SMC (client) and a remote HSC subsystem (server). The HTTP server executes as a separate subsystem on the MVS host where the remote HSC subsystem resides.

## Automated Cartridge System Library Software (ACSL)

The ACSL software manages library contents and controls library hardware for the mounting and dismounting of cartridges.

ACSL provides library management services, such as cartridge tracking, pooling, reports, and library control. It maintains a database that tracks data volume names and their current locations in the libraries.

# Operating Modes

Four modes of operation are possible for the SL3000:

- [Automated Mode](#)
- [Manual Mode](#)
- [Maintenance Mode](#)
- [Degraded Mode](#)

## Automated Mode

When in automated mode of operation, the library automatically mounts and dismounts cartridges without physical intervention by a person.

Automated operations include the following activities:

- Mounting and dismounting cartridges
- Entering and ejecting cartridges through the CAP
- Logging library events
- Drive cleaning

See [Chapter 3, “SL3000 Automated Library Operations” on page 73](#) for complete details.

## Manual Mode

Manual mode of operation occurs when the library is unavailable for system use and human intervention is required. An example of this situation would be when a library experiences an unrecoverable error, making automated mounts and dismounts impossible.

Another example would be where a library component cannot perform a mount to a drive for a particularly important job request. In this case, the library may require a person to enter a library, locate the cartridge, and manually mount it into the requested drive.

---

**Warning – Possible Physical Injury. Anyone entering the library must be advised of the safety procedures required of them.**

---

See [Chapter 8, “Manual Operations” on page 475](#) for complete details.

## Maintenance Mode

In the case of a failure in a non-redundant library component (for example, a single TallBot for the entire library), the library is said to be “unavailable” to the system. In this case, the entire library must be placed offline until the repair is accomplished.

After the defective component has been repaired or replaced, the library can be placed in maintenance mode while verification tests are performed.

## Degraded Mode

When in degraded mode, the library is still operational and online, but its operational efficiency is degraded due to a failing component. Examples of degraded mode are:

- In a redundant TallBot configuration, one TallBot has failed; the other TallBot has assumed all mount and dismount operations for the entire library.
- A single tape drive has experienced a failure and must be replaced.



# StorageTek Library Console

---

---

## Introduction

The StorageTek Library Console (SL Console) is a Java-based software application that provides a graphical user interface (GUI) for monitoring and managing the StorageTek library.

Following are some of the activities you can perform with the SL Console:

- Manage available library storage capacity
- Manage and configure library partitions (optional feature)
- View and modify status and properties of the library and associated devices (drives, CAP, robots, and elevators)
- Perform an audit on all or part of the library
- Perform a self-test on the library or an associated device
- Perform a diagnostic move (exercise a robot)
- Locate a cartridge
- Move a cartridge from one location to another
- Display library logs
- Display library status event messages
- Display error explanations
- Download new library firmware while the library is in operation
- Display context-sensitive help

---

## SL Console Modes

Depending on your needs, you can run the SL Console in any of the following modes. For details and procedures, see:

- [“Local Operator Panel” on page 40](#)
- [“Web-launched SL Console” on page 42](#)
- [“Standalone SL Console” on page 44](#)

## SL Console Security

Security features built into the SL Console control both user authentication and user authorization. The security features include:

- User IDs – User IDs control user authentication. Each user must have a valid, active user ID and password to log in to the SL Console.
- Access permissions – Access permissions control user authorization. Each user ID is assigned a set of access permissions, which determine the types of requests the user can submit through the SL Console. For example, in order to modify the system properties of a drive, a user must log in with a user ID that has the proper access permissions.

When you log in to the SL Console with a valid user ID, password, and library name, the system authenticates your identity and then authorizes your access to the various SL Console functions.

### User IDs

To log in to the SL Console, you must have a valid, active user ID. Each user ID must be assigned a password.

There are a fixed set of user IDs at a site. The user IDs include `admin` (customer administrator), `service` (Sun Customer Services Engineer), and `oem` (third-party field service technician). When you log in successfully, the SL Console displays your user ID in the status bar of the screen.

Only one user at a time can be logged in to the local operator panel, but any number of users can connect to a library through the standalone SL Console or Web-launched SL Console.

### Activation Password

Before any users at your site can use the SL Console for the first time, your library administrator must activate the “admin” userid with a special activation password. Your Sun support representative provides your administrator with the activation password, which is valid for one-time use only.

After logging in with the activation password, the administrator must change the admin user ID password to ensure system security.

For details about this process, see the appropriate library *Installation Guide*.

# SL Console Screen Display

The following figure and table explain the components of the SL Console screen.

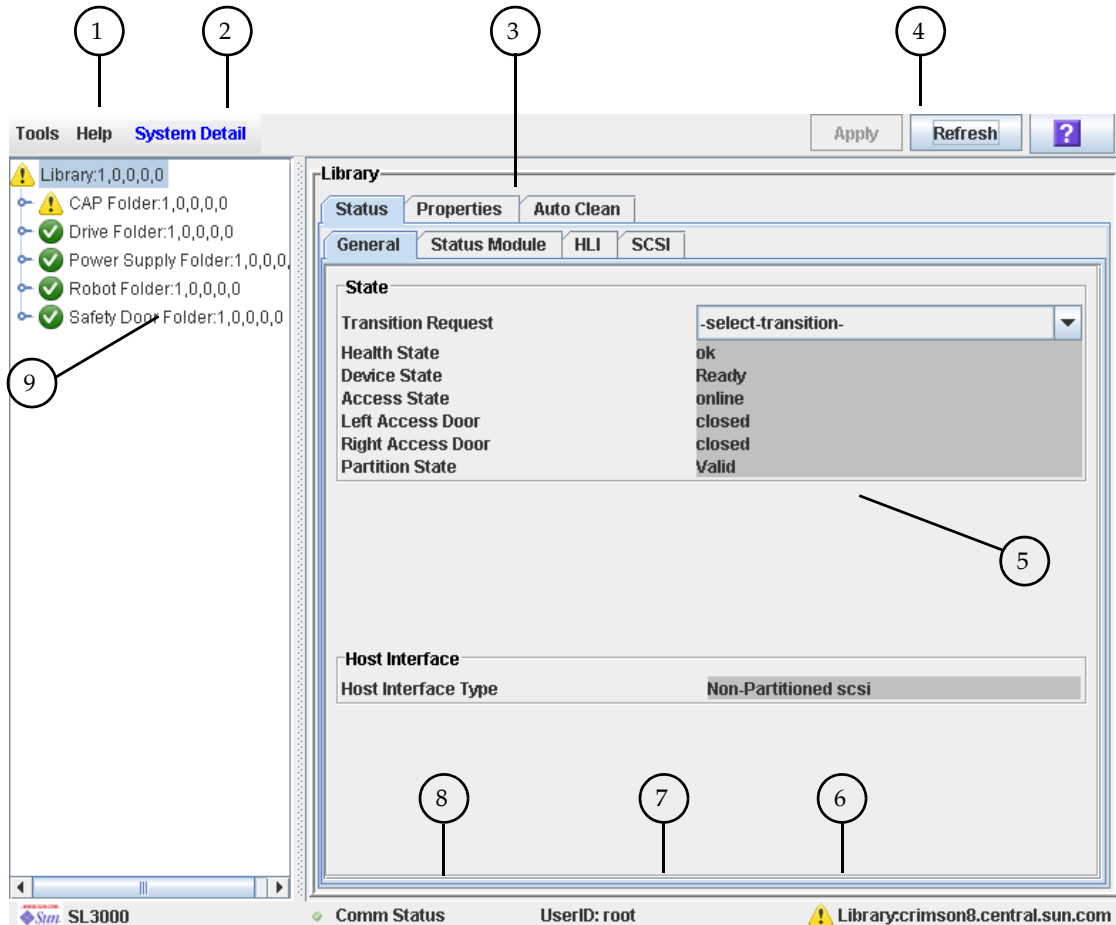

Component Name	Description
1	Menu bar – includes the Tools Menu and the Help Menu Tools menu provides access to System Detail, Reports, Monitors, Utilities, Partitioning, User Management, and Log off functions. Help menu provides access to the table of contents of the help system. It also identifies the version of the SL Console in use.
2	Title bar Displays the title of the current screen.
3	Function tabs Identifies the available functions for a screen.
4	Options bar Location of buttons related to the screen (for example, <b>Apply</b> , <b>Refresh</b> , <b>Print</b> ). Always includes the SL Console <b>Help</b> button (?). See <a href="#">“Synchronizing the Display With the Controller Database” on page 36</a> for details on using the <b>Apply</b> and <b>Refresh</b> buttons.

	<b>Component Name</b>	<b>Description</b>
5	Work area	Location of the screen data.
6	Library health indicator	Identifies the library to which the SL Console is connected, and displays a graphical representation of the library health.
7	UserID indicator	Displays the user ID currently logged in to the SL Console.
8	Server communication health indicator	Displays a graphical heartbeat monitor indicating the state of server communication health.
9	Device tree	Lists the devices included in the library.

## Modifying the Screen Layout

**Note** – This feature is available starting with SL Console version FRS\_3.30. It is available on selected screens only.

You can modify the layout and display of selected SL Console screens as follows.

<b>Display Option</b>	<b>Instructions</b>
Sort the display by any column	Click the heading of the column you want to sort by. Initially the sort is in ascending order. Click the heading again to switch between ascending and descending order.
Arrange the columns in any order	Click and drag a column heading horizontally to any position in the heading row.
Resize the columns	Click the border of the column heading and drag it left or right to change the column width.

## Synchronizing the Display With the Controller Database

### Logging In

The SL Console gets all library configuration data from the library controller. Therefore, you should be careful when logging in to the SL Console before the library has fully initialized. You may see warnings that configuration data is not yet available, in which case you need to exit and log in again at a later time. Additionally, if a library audit is performed as part of initialization, until the audit is complete, any configuration data displayed may not be completely up-to-date and accurate.

### Making Library Configuration Updates

When you first bring up an SL Console screen, the display reflects the most recently saved data from the library controller database. If you use the screen to modify the library contents or configuration, your changes do not update the controller database



until you commit your changes by clicking the **Apply** button. Multiple users can access the library at the same time, using the SL Console, command line interface, and various host applications to make their own changes to the library contents and configuration. If other users make changes and apply them to the controller database, you will not see these changes until you click **Apply** or **Refresh** on your screen. Therefore, the display you see on the SL Console may not reflect the actual saved library configuration at a given point in time.

For these reasons, if you are making major modifications to the library configuration – adding modules, defining partitions, etc. – it is important that you coordinate these changes with other library users. Failure to do so could result in conflicts within the controller database.

# SL Console Help

The SL Console Help displays information for library operators, system programmers, system administrators, and service representatives.

---

**Note** – The information relates specifically to the SL Console only. For information about library hardware, tape drives, or host software, see the appropriate product publication.

---

Following is a sample SL Console Help screen.

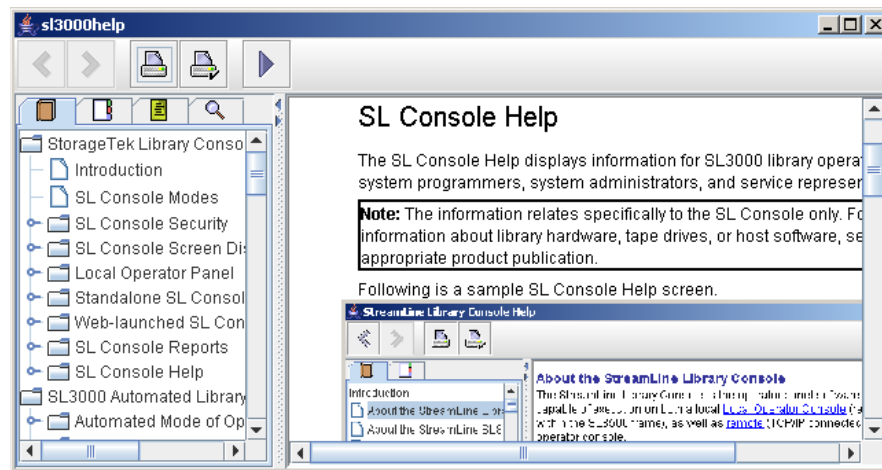

## Accessing the SL Console Help

You can display the SL Console Help from any SL Console screen. Use either of the following methods:

- To display context-sensitive help for the current SL Console screen, click the ? button in the Options bar.
- To display general help information, click **Help > Contents** in the Menu bar.







## Help Navigation

The left panel of the SL Console Help screen displays either of the following:

- Table of contents (TOC) – An outline of topics and subtopics
- Index – A list of terms and topics, in alphabetical order

The right panel displays the Help topic itself.

The top of the SL Console Help screen includes the following navigation buttons.

Button	Action
 <b>Back</b>	Retraces your steps, going backward one topic at a time.
 <b>Forward</b>	Retraces your steps, going forward one topic at a time.
 <b>Print</b>	Displays the <b>Print</b> popup, which allows you to print one or more topics: <ul style="list-style-type: none"> <li>■ To print the current topic, click the <b>Print</b> button.</li> <li>■ To print a different topic, click the topic title in the SL Console Help table of contents, and click the <b>Print</b> button.</li> <li>■ To print more than one topic, highlight the topics in the SL Console Help table of contents by pressing <b>Shift-Click</b> or <b>Ctrl-Click</b>, and then click the <b>Print</b> button.</li> </ul>
 <b>Print Setup</b>	Displays the <b>Page Setup</b> popup, which allows you to modify your print page layout.
 <b>TOC</b>	Displays the SL Console Help table of contents.
 <b>Index</b>	Displays the SL Console Help index.

## Tips for Using the SL Console Help

- You can minimize, maximize, or resize the Help screen to accommodate your needs.
- You can resize the left and right panels of the Help screen by clicking the border between them and dragging it left or right.
- Most topics include a **Related Topics** button at the bottom of the page. Click on this button to display and navigate to help topics containing related information.

# Local Operator Panel

The local operator panel is an optional feature of the library, which is built in to the Base Module. It enables you to run most of the SL Console application directly at the library from a flat-screen display with a touch screen interface.

The local operator panel has the following features:

- Flat-panel display (12.1-inch), resident within the library
- Touch screen interface, allowing alphanumeric data entry; stylus available; see “Virtual Keypad” for details.
- No keyboard or mouse option

LEDs located directly below the local operator panel provide the following status information:

- Library Active – Library processor is working.
- Wait – Library firmware is loading.
- Service Required – Library is rebooting.

## Virtual Keypad

Some screen fields require you to make a text entry. The local operator panel displays a keyboard icon next to these fields. By clicking on the keyboard icon, you can display a virtual keypad, which allows you to enter valid alphanumeric characters into the field. The following figure illustrates the keyboard icons on a sample screen.

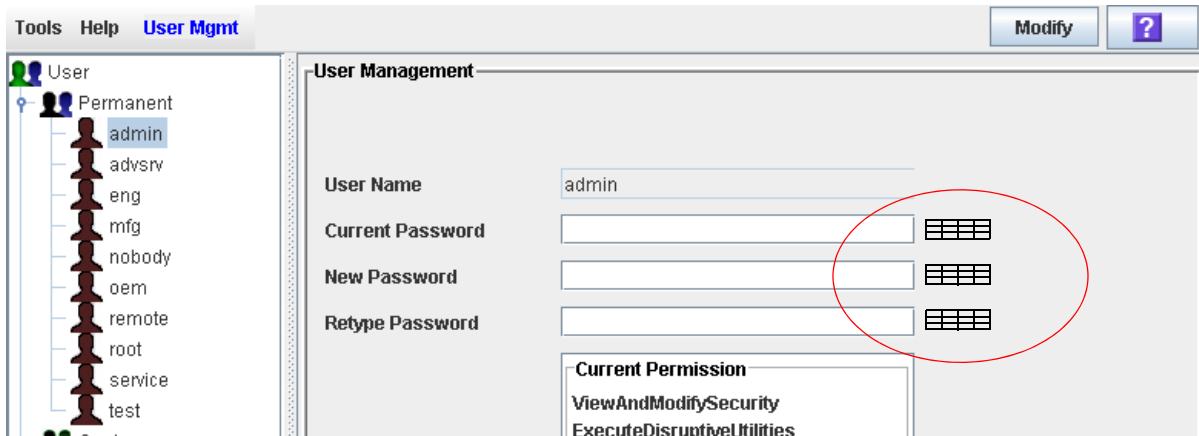

The virtual keypad provides the standard alphanumeric and symbol characters. It allows you to enter only characters that are valid for the current field; characters that are not valid are grayed out.

The virtual keypad also provides the following cursor movement buttons:

Button	Function
<b>Insert</b>	If highlighted, inserts text at the cursor position. If not highlighted, replaces text to the right of the cursor.
<b>Home</b>	Places cursor at the beginning of the field.
<b>Del</b>	Deletes character to the right of the cursor.
<b>End</b>	Places cursor at the end of the field.
<b>Back</b>	Deletes character to the left of the cursor
<b>Clear</b>	Clears the entire field
<b>Left</b>	Moves cursor one character to the left
<b>Right</b>	Moves cursor one character to the right
<b>OK</b>	Submits the text entry in the field
<b>Cancel</b>	Cancels the text entry in the field and dismisses the virtual keypad

## Touch Screen Calibration

Alignment of the local operator panel touch screen is calibrated at the factory. The factory settings are appropriate for most situations, and it is usually not necessary for you to make any adjustments. On rare occasions, however, the touch screen may come out of alignment or need adjustment.

To re-calibrate the touch screen, proceed as follows:

- If you have a Linux-based local operator panel, you can re-calibrate it yourself. See [“Re-calibrate the Local Operator Panel” on page 62](#) for detailed instructions.
- If you have a Windows-based local operator panel, contact your Sun support representative. Windows-based local operator panels can be re-calibrated only by an authorized service representative.

If you have a Linux-based local operator panel, you can re-set the touch screen to its factory settings at any time. See [“Reset the Local Operator Panel Calibration” on page 65](#) for detailed instructions.

---

## Web-launched SL Console

The Web-launched SL Console is a standard feature of the library. It enables the SL Console to be installed on a centralized Web server. Individual clients can then use a supported Web browser to download the Web-launched SL Console. Using the Web-launched SL Console you can connect to any library for which you have a valid user ID.

The Web-launched SL Console is delivered to clients as a Java Web Start process, which executes outside the browser.

## Security Considerations

The Web-launched SL Console software is digitally signed, which guarantees that it has been issued by Sun Microsystems, Inc. and has not been altered or corrupted since it was created. As a Java Web Start process, the Web-launched SL Console includes the security features provided by the Java 2 platform.

The customer is responsible for implementing all appropriate additional security systems, including firewalls, user access, etc.

## Client Requirements

You can download the Web-launched SL Console to clients meeting the following requirements:

---

<b>Platform</b>	Solaris 9 – SPARC (Firefox 2.x) Solaris 10 – SPARC (Firefox 2.x) Windows 2000 – 32 bit (IE 5, IE 5.5, Firefox 2.x) Windows XP – 32 bit (IE 6, IE 7, Firefox 2.x) Windows Vista – 32 bit (IE 7, Firefox 2.x)
<b>Other</b>	<ul style="list-style-type: none"><li>■ Java 1.5 Plug-in (the browser will install this automatically if it is not present already)</li><li>■ Ethernet connection to the library</li><li>■ Ethernet connection to the Web-launched SL Console server</li></ul>

---

## Web-launched SL Console Updates

Updates to the Web-launched SL Console only need to be installed on the centralized Web server. Once the updates are installed on the server, they are downloaded automatically to all clients whenever the application is started on the client.

## Starting the Web-launched SL Console on a Client

You can use either of the following methods to start and log in to the Web-launched SL Console on a client:

- From a command line (Solaris only) or supported browser. See [“Log in to the Web-launched SL Console Using a Browser or Command Line” on page 49.](#)
- By double-clicking the `slc.jnlp` icon on your client. In order to use this method from a client, you must use the browser method at least once and save the `slc.jnlp` file locally. See [“Log in to the Web-launched SL Console Using an Icon” on page 54.](#)

---

## Standalone SL Console

The standalone SL Console is a standard feature of the StorageTek library. It enables you to run the SL Console application remotely from a PC or workstation that has a network connection to the library. Using the standalone SL Console you can connect to any library for which you have a valid user ID.

## Security Considerations

The SL Console application interfaces with the primary library interface (PLI) over a security software layer (SSL). The SSL provides a secure communication path between the library and the customer's operator panel; this prevents an unauthorized network user from monitoring library activity.

## Installation Requirements

You can install the standalone SL Console on a computer meeting the following requirements:

---

<b>Platform</b>	Solaris 9 – SPARC Solaris 10 – SPARC Windows 2003 Server – 32 bit Windows XP Client – 32 bit Windows Vista – 32 bit
<b>Other</b>	Ethernet connection to the library

---

The standalone SL Console software is available for download at the following Sun Microsystems, Inc. sites:

---

<b>User</b>	<b>Location Name</b>	<b>URL</b>
Sun Customers	Sun Download Center	<a href="http://www.sun.com/download/index.jsp">http://www.sun.com/download/index.jsp</a>
Sun Partners and OEMs	Sun Partner Exchange	<a href="https://spe.sun.com/spx/control/Login">https://spe.sun.com/spx/control/Login</a>

---

**Note** – You must have a valid login ID and password for the download site you are using. Contact your Sun support representative for assistance.

---



## Standalone SL Console Updates

---

**Note** – Before you can install a new version of the standalone SL Console, you must uninstall the previous version. See your PC or workstation documentation for detailed instructions. Running multiple versions of the SL Console on the same PC or workstation can cause problems such as inconsistent data on reports.

---

Once you have uninstalled the previous version of the SL Console, see the following procedures for detailed instructions on upgrading the software.

- [“Download the Standalone SL Console Installer” on page 67](#)
- [“Install the Standalone SL Console” on page 68](#)

# SL Console Task Summary

SL Console tasks are divided into the following categories:

- [“General SL Console Usage Tasks” on page 47](#)
- [“Local Operator Panel Calibration Tasks” on page 61](#)
- [“Standalone SL Console Installation Tasks” on page 66](#)

---

# General SL Console Usage Tasks

<b>Task</b>	<b>Page</b>
<a href="#">Log in to the Local Operator Panel</a>	48
<a href="#">Log in to the Web-launched SL Console Using a Browser or Command Line</a>	49
<a href="#">Log in to the Web-launched SL Console Using an Icon</a>	54
<a href="#">Log in to the Standalone SL Console</a>	58
<a href="#">Log Off the SL Console</a>	59
<a href="#">Change a User Password</a>	60

## ▼ Log in to the Local Operator Panel

Use this procedure to log in to the local library.

---

**Note** – Only one user at a time can log in to the local operator panel.

---

1. If the touch screen panel is blank, touch the screen anywhere to activate the Login screen.
2. Use the virtual keypad to enter your login information (see [“Virtual Keypad” on page 40](#) for details).

User ID: *SLC\_login*

Password: *password*

where:

- *SLC\_login* is the SL Console user ID.
- *password* is the password assigned to this user ID.

---

**Note** – The user ID you use determines the screens you can access. See [“SL Console Security” on page 34](#).

---

3. Click **Log on**.

## ▼ Log in to the Web-launched SL Console Using a Browser or Command Line

---

**Note** – Before you perform this activity, you must obtain the DNS alias or IP address of the SL Console server. Depending on how your Web-launched SL Console server has been set up, it may be accessible only by IP address. See your library administrator for assistance.

---



---

**Note** – The command line option is available on Solaris platforms only.

---

On Windows 2000, you may need to install a Java plugin for your Web browser before performing this procedure. You can download the plugin from the following location: [http://java.sun.com/products/archive/j2se/5.0\\_04/index.html](http://java.sun.com/products/archive/j2se/5.0_04/index.html)

On Solaris platforms, it is easier to log in to the Web-launched SL Console using the command line. If you prefer to log in using a Web browser, however, you need to download a recent version of the Firefox Web browser from the following location: [www.mozilla.com](http://www.mozilla.com)

### 1. Choose your login method:

- Command line – available on Solaris only. Proceed to [Step 2](#).
- Web browser – available on either Windows or Solaris. Proceed to [Step 3](#).

### 2. Open a terminal window, and type the following command:

```
javaws http://server_ID/opel/slc.jnlp
```

where:

- *server\_ID* is either of the following:
  - IP address of the SL Console server (in *nnn.nnn.nnn.nnn* format)
  - DNS alias of the SL Console server
- *opel* is the name (context root) of the Web-launched SL Console application on the server.

Proceed to [Step 4](#).

### 3. Start a supported Web browser on your client PC or workstation (see “[Client Requirements](#)” on [page 42](#) for a list of supported browsers), and in the Location Bar or Address field, enter the URL of the SL Console Web Start application:

```
http://server_ID/opel
```

where:

- *server\_ID* is either of the following:
  - IP address of the SL Console server (in *nnn.nnn.nnn.nnn* format)
  - DNS alias of the SL Console server
- *opel* is the name (context root) of the Web-launched SL Console application on the server.

---

**Note** – You can bookmark this URL for future logins.

---

The **SL Console Launch** screen appears.

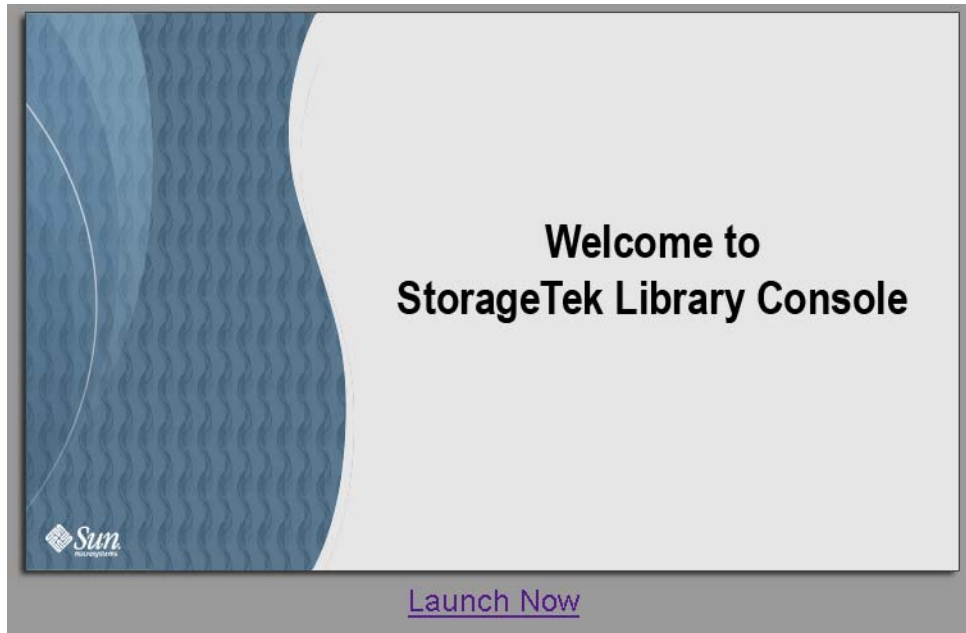

**4. Click Launch Now.**

The Web Start process retrieves the Web-launched SL Console application from the server. Any updates are downloaded automatically.

The **Opening slc.jnlp** popup appears.

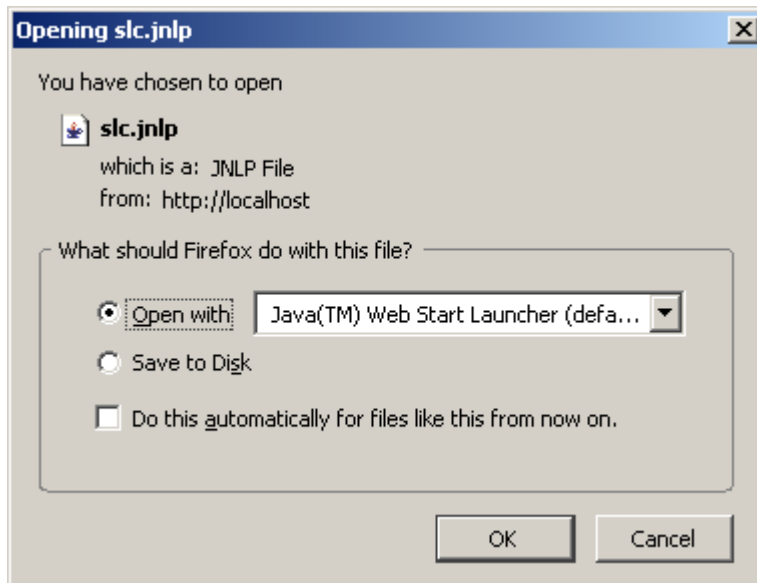

**5. Complete the popup as follows:**

- a. Specify the action you want to take with the `slc.jnlp` file:

- Click the **Open with Java(TM) Web Start Launcher** radio button if you want to start the SL Console directly.
  - Click the **Save to Disk** radio button if you want to save the `slc.jnlp` file to your client and log in to the SL Console later. See [“Log in to the Web-launched SL Console Using an Icon”](#) on page 54 for login instructions.
- b. Optionally click the **“Do this automatically for files like this from now on”** checkbox. If you make this selection, this popup will not appear during future logins.
- c. Click **OK**.

If this is the first time you are running the Web-launched SL Console, a digital signature warning popup appears.



6. Complete the popup as follows:
- a. Verify the Publisher.
  - b. Optionally click the **“Always trust content from the publisher”** checkbox. If you make this selection, this popup will not appear during future logins.

c. Click Run.

If this is the first time you are running the Web-launched SL Console, the **License Agreement** popup appears.





7. Scroll down to read the complete license agreement. Click, "I accept the terms of the License Agreement", and then click OK.

The SL Console Login screen appears.



8. Enter your login information, and click Log on.

User ID: *SLC\_login*

Password: *password*

Library: *library\_ID*

where:

- *SLC\_login* is the SL Console user ID.
- *password* is the password assigned to this user ID.
- *library\_ID* is the library to which you want to connect, expressed in either of the following ways:
  - IP address of the library, in dotted decimal notation (*nnn.nnn.nnn.nnn*)
  - DNS alias of the library

---

**Note** – The user ID you use determines the screens you can access. See ["SL Console Security" on page 34](#).

---

## ▼ Log in to the Web-launched SL Console Using an Icon

---

**Note** – In order to perform this activity, you must first save the Web-launched SL Console `slc.jnlp` file to your client. See [“Log in to the Web-launched SL Console Using a Browser or Command Line”](#) on page 49 for details.

---

1. **Double-click the `slc.jnlp` desktop icon on your client.**

The Web Start process retrieves the Web-launched SL Console application from the server. Any updates are downloaded automatically.

The **SL Console Launch** screen appears.

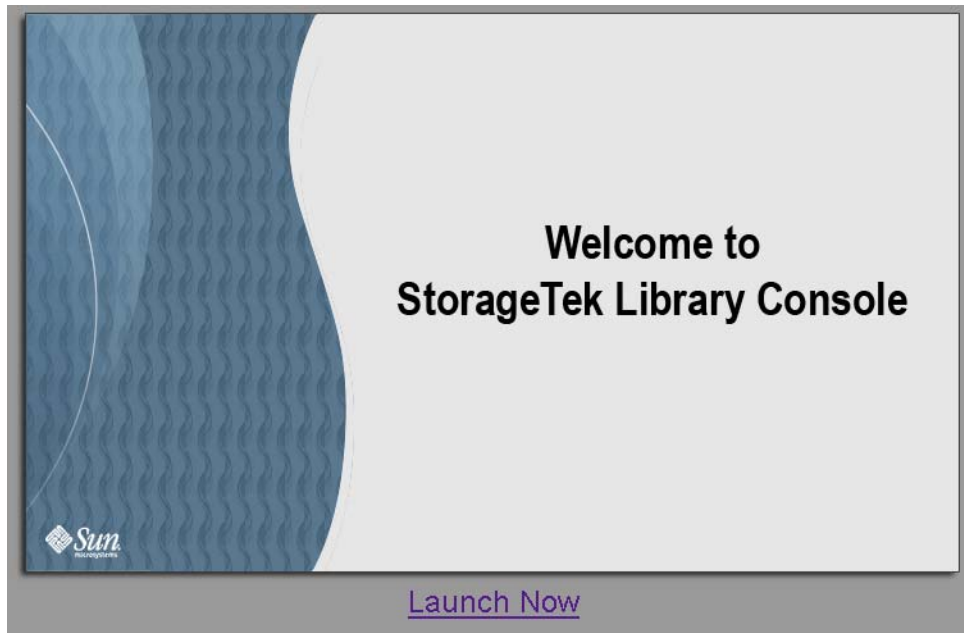

**2. Click Launch Now.**

The Web Start process retrieves the Web-launched SL Console application from the server. Any updates are downloaded automatically.

If this is the first time you are running the Web-launched SL Console, a security warning popup appears.

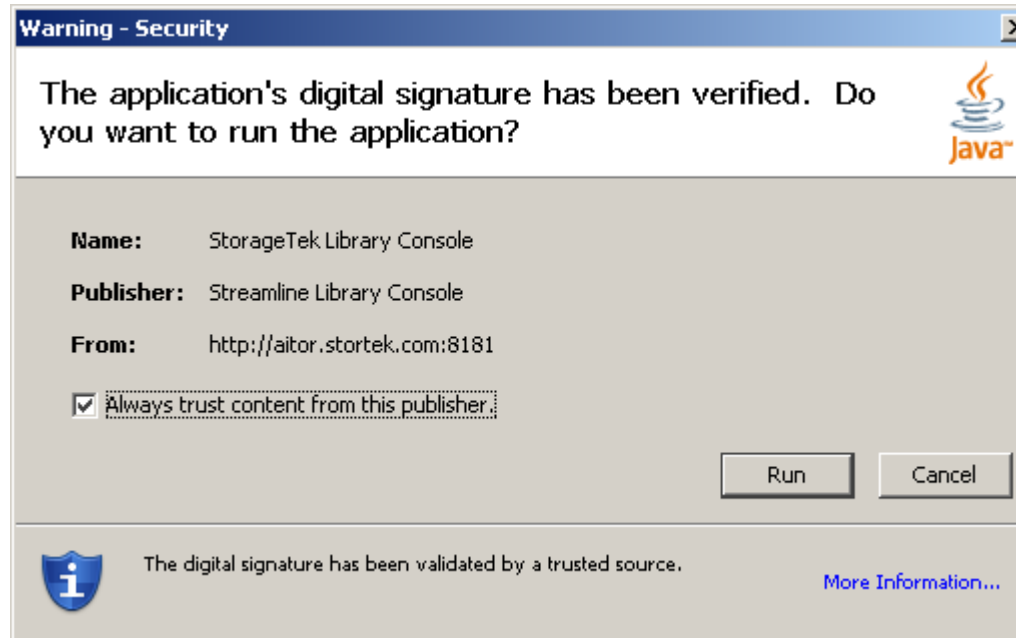
**3. Complete the popup as follows:**

- a. Verify that the Publisher is Sun Microsystems, Inc.
- b. Optionally click the "Always trust content from the publisher" checkbox. If you make this selection, this popup will not appear during future logins.

c. Click Run.

If this is the first time you are running the Web-launched SL Console, the **License Agreement** popup appears.



4. Scroll down to read the complete license agreement. Click, "I accept the terms of the License Agreement", and then click OK.

The SL Console Login screen appears.

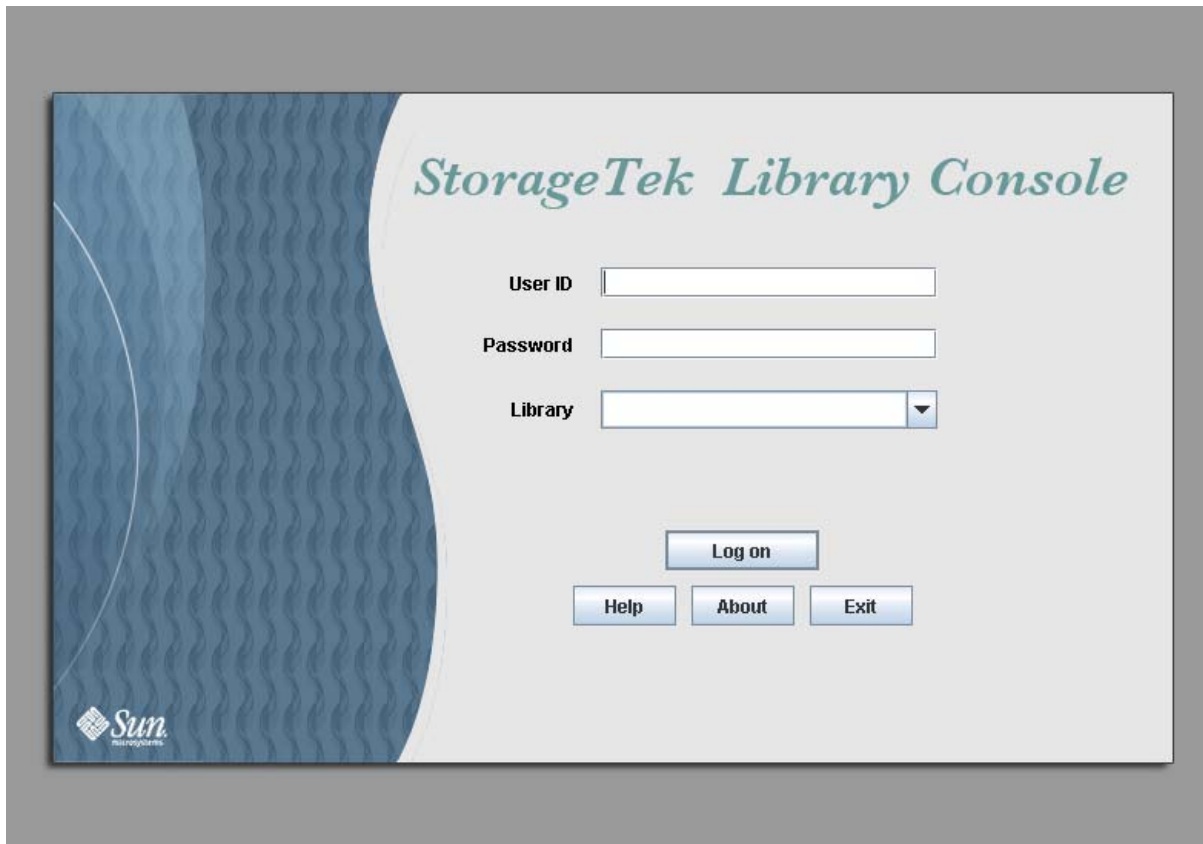

5. Enter your login information, and click Log on.

User ID: *SLC\_login*

Password: *password*

Library: *library\_ID*

where:

- *SLC\_login* is the SL Console user ID.
- *password* is the password assigned to this user ID.
- *library\_ID* is the library to which you want to connect, expressed in either of the following ways:
  - IP address of the library, in dotted decimal notation (*nnn . nnn . nnn . nnn*)
  - DNS alias of the library

---

**Note** – The user ID you use determines the screens you can access. See ["SL Console Security" on page 34.](#)

---

## ▼ Log in to the Standalone SL Console

1. **Start the SL Console application on your PC or workstation by doing either of the following:**

- Double-click the **SL Console** icon on the desktop.
- Select **Start > RunSLConsole** or **Launch > RunSLConsole**

The SL Console starts and the **Login** screen appears.

2. **Enter your login information.**

User ID: *SLC\_login*

Password: *password*

Library: *library\_ID*

where:

- *SLC\_login* is the SL Console user ID.
- *password* is the password assigned to this user ID.
- *library\_ID* is the library to which you want to connect, expressed in either of the following ways:
  - IP address of the library, in dotted decimal notation (*nnn.nnn.nnn.nnn*)
  - DNS alias of the library

---

**Note** – The user ID you use determines the screens you can access. See [“SL Console Security” on page 34](#).

---

3. **Click Log on.**

## ▼ Log Off the SL Console

---

**Note** – Before you log off, make sure all operations for the current SL Console session have completed (for example, code loads, audits, diagnostic moves).

---

1. From any SL Console screen, select **Tools > Log Off**.

The **Confirm** popup appears.

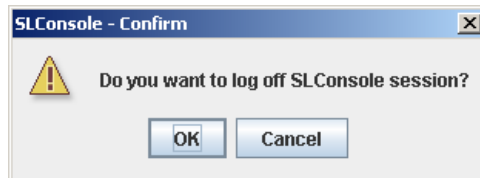

---

**Note** – To remain logged in to the SL Console, click **Cancel**. You are returned to the originating screen without logging off.

---

2. Click **OK**.

You are logged off the SL Console, and the **Login** screen appears.



3. Click **Exit** to close the SL Console.

## ▼ Change a User Password

Use this procedure to change the password for a user account.

1. Log in to the SL Console using any of the modes available to you (local operator panel, Web-launched SL Console, or standalone SL Console). You must log in using the user account you want to modify.

2. Select Tools > User Mgmt.

The User Management screen appears.

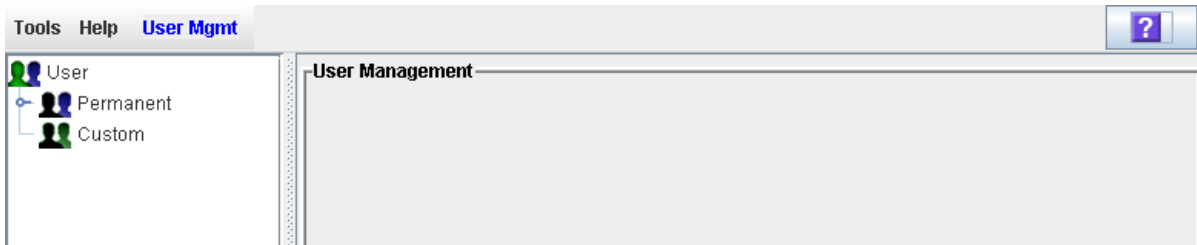

3. On the User tree, expand the Permanent folder, and click the user account you want to modify (the user account you are logged in as).

Detailed information for the user account is displayed.

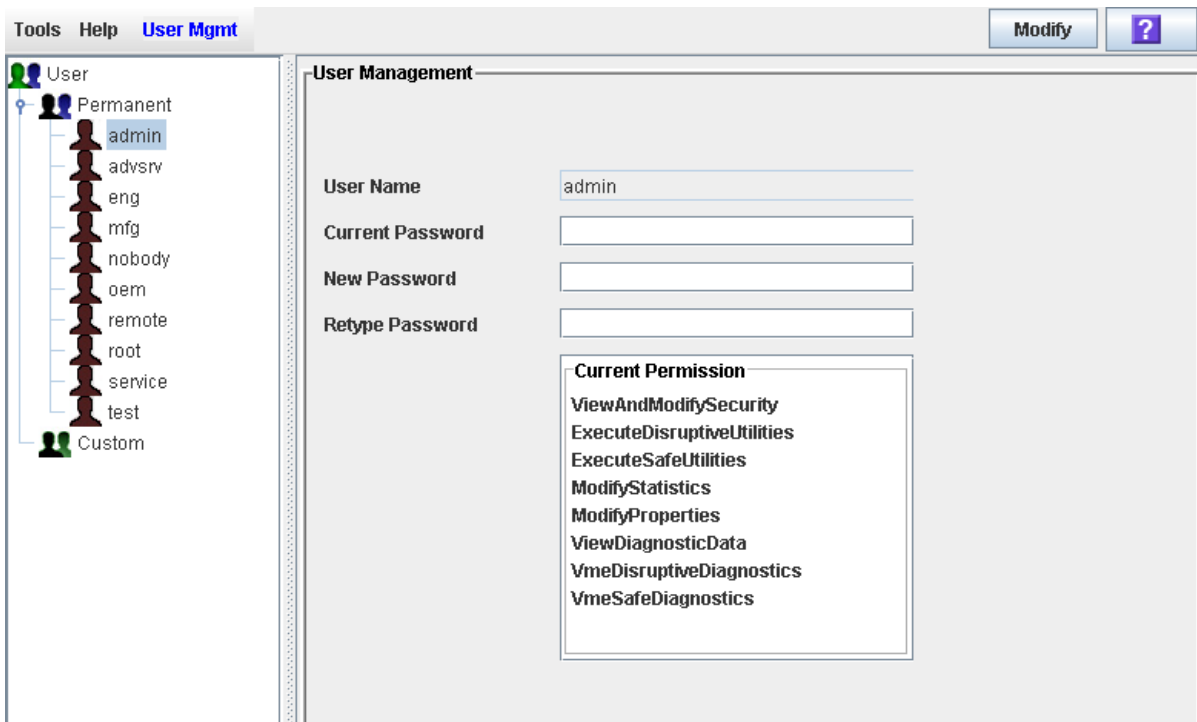

4. Complete the following fields: Current Password, New Password, and Retype Password.

5. Click Modify.

The password for the account is updated.



---

# Local Operator Panel Calibration Tasks

<b>Task</b>	<b>Page</b>
<a href="#">Re-calibrate the Local Operator Panel</a>	62
<a href="#">Reset the Local Operator Panel Calibration</a>	65

## ▼ Re-calibrate the Local Operator Panel

Use this procedure to change the alignment of the local operator panel touch screen. The touch screen comes pre-calibrated from the factory, and in most cases no adjustment is necessary. Typically, you would use this procedure only if the touch screen has come out of alignment.

---

**Note** – This procedure can be performed only at a Linux-based local operator panel. To re-calibrate a Windows-based local operator panel, contact your Sun support representative.

---

---

**Note** – Before beginning this procedure, make sure there is no debris on the touch screen, as this can interfere with an accurate calibration.

---

---

**Note** – You can re-set the touch screen to its factory settings at any time. See [“Reset the Local Operator Panel Calibration” on page 65](#) for detailed instructions.

---

**1. Log in to the local operator panel.**

See [“Log in to the Local Operator Panel” on page 48](#) for detailed instructions.

**2. Select Tools > Calibrate.**

The **Select Calibration Option** popup appears.



### 3. Click Calibrate.

The alignment sequence begins. Ten targets are presented sequentially on the screen.

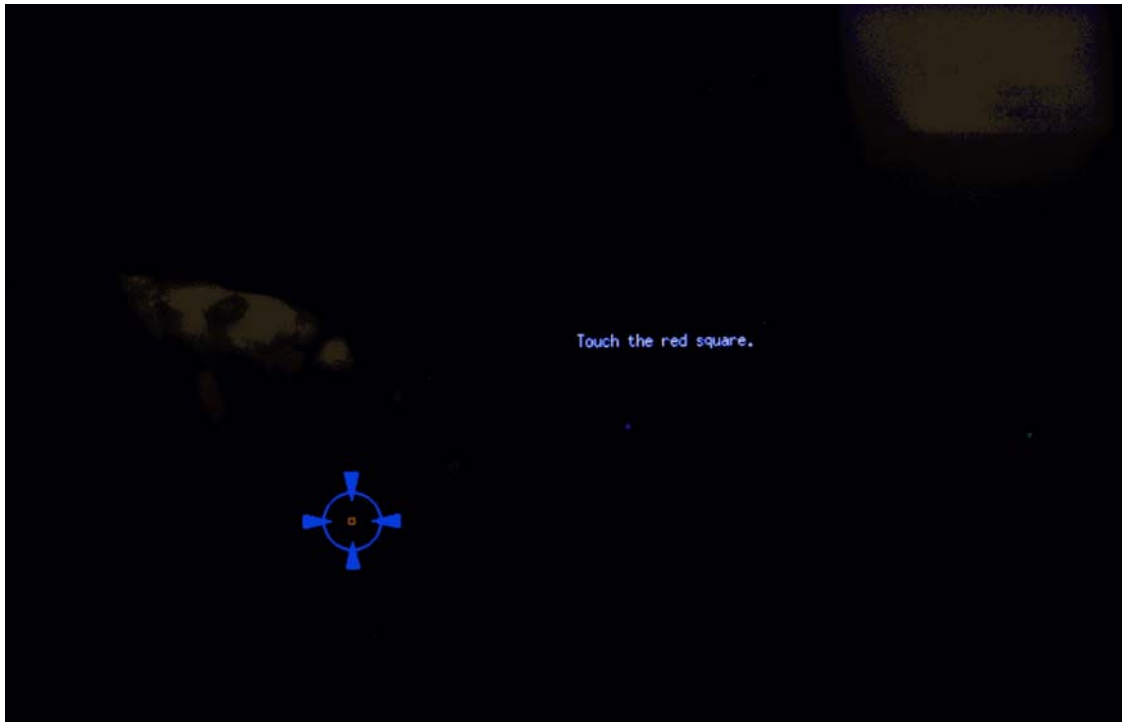

### 4. Gently tap in the center of each target with your finger or a pointing stylus.

This aligns the screen according to your touch. Be sure to touch the center of each target so you can get an accurate calibration.

---

**Note** – If you tap outside of a target, you can potentially mis-align your touch screen. Depending on the severity of the mis-alignment, you may have trouble logging back into the local operator panel if you save these new settings. See [Step 7](#) for instructions on discarding settings.

---

After you touch the last target of the alignment sequence, the first of two **Accept Calibration** popups appears, with a **Click Me** button on the left side of the popup.



### 5. Proceed as follows with the agility test, depending on whether the new alignment settings are good:

- To save the new alignment settings, proceed to [Step 6](#).
- To discard the new settings, proceed to [Step 7](#).

### 6. Use the following steps to save the new settings.

- a. On the Accept Calibration popup, touch the Click Me button within the indicated time period.

- If the button depresses when you touch it directly, the touch screen is properly aligned. The second **Accept Calibration** popup appears, this time with a **Click Me** button on the right side of the popup.



- If the button does not depress when you touch it directly, the touch screen is not properly aligned and you should discard the new settings. Proceed to [Step 7](#).
- b. **On the second Accept Calibration screen, touch the Click Me button within the indicated time period.**

If you depress the button successfully, the alignment settings are saved and the **Calibration Accepted** popup appears.



- c. **Click OK to dismiss the popup and save the new settings.**

The new settings are effective immediately, and the display returns to the SL Console screen. The local operator panel is not rebooted.

7. **Use the following steps to discard the new settings.**

- a. **On either Accept Calibration popup, let the timer run out without touching the Click Me button.**

The **Retry Calibration** countdown message appears.



- b. **The calibration sequence screen is presented again. Return to [Step 4](#) to try the calibration a second time.**

---

**Note** – If you are not able to successfully calibrate the screen on the second try, the local operator panel is rebooted automatically, and the alignment is restored to the previously saved settings.

---

## ▼ Reset the Local Operator Panel Calibration

Use this procedure to restore the alignment of the local operator panel touch screen to the factory settings. This procedure forces a reboot of the local operator panel, which takes several minutes.

---

**Note** – This procedure is available only for a Linux-based local operator panel. To reset the calibration of a Windows-based local operator panel, contact your Sun support representative.

---

**1. Log in to the local operator panel.**

See [“Log in to the Local Operator Panel”](#) on page 48 for detailed instructions.

**2. Select Tools > Calibrate.**

The **Select Calibration Option** popup appears.



**3. Click Reset Calibration.**

The current touch screen calibration settings are discarded, and the alignment is restored to the factory settings. The **Calibration Reset** countdown message is displayed.

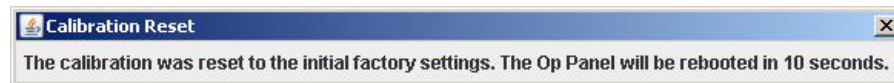

The local operator panel is rebooted automatically, and the display returns to the SL Console screen.

---

**Note** – The reboot takes several minutes.

---

---

# Standalone SL Console Installation Tasks

<b>Task</b>	<b>Page</b>
<a href="#">Download the Standalone SL Console Installer</a>	67
<a href="#">Install the Standalone SL Console</a>	68

## ▼ Download the Standalone SL Console Installer

Use this procedure to download the standalone SL Console installer program from the Sun download site, and initiate it on your PC or workstation.

---

**Note** – Your StorageTek CSE may have performed this procedure for you during library installation.

---

---

**Note** – You must have a valid login ID and password for the download site you are using. Contact your Sun support representative for assistance.

---

1. Start a Web browser on your PC or workstation.
2. In the Address or Location Bar, enter the URL of the appropriate Sun download site. See [“Installation Requirements”](#) on page 44 for details.
3. Log in to the Sun download site using your assigned login ID and password.
4. Navigate to the standalone SL Console installer file.
5. Select the SL Console code level you want.
6. Select the appropriate installer file for your platform:
  - Microsoft Windows: SLConsoleWindowsSTK.exe
  - Sun Solaris: SLConsoleSolarisSTK.bin
7. Save the file to your PC or workstation.

---

**Note** – To complete the installation, see [“Install the Standalone SL Console”](#) on page 68.

---

## ▼ Install the Standalone SL Console

Use this procedure to install the standalone SL Console on your PC or workstation.

---

**Note** – Your StorageTek CSE may have performed this procedure for you during library installation.

---

---

**Note** – Prior to using this procedure, you must have downloaded the standalone SL Console installer program. See [“Download the Standalone SL Console Installer”](#) on page 67.

---

1. Double-click the SL Console installer file icon on your PC or workstation to start the installation.

The **License Agreement** screen appears.

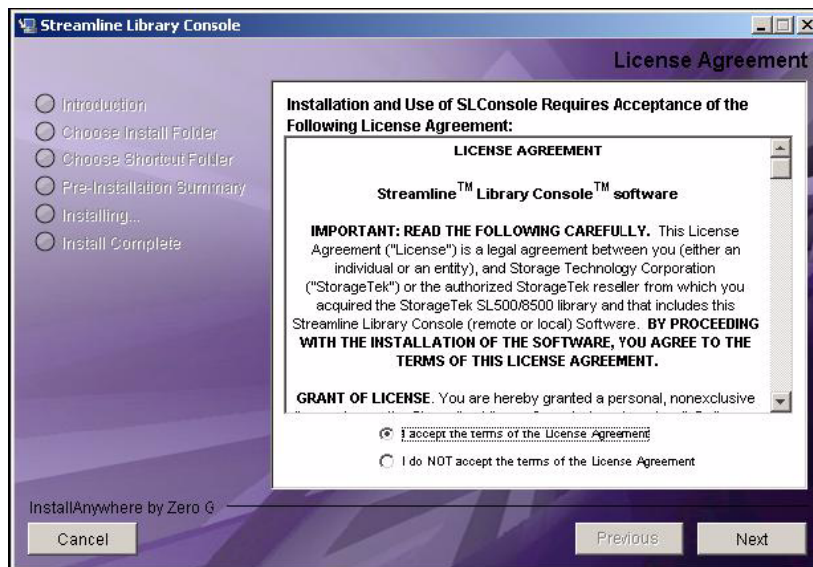



2. Review the information, and click I accept.

The Introduction screen appears.

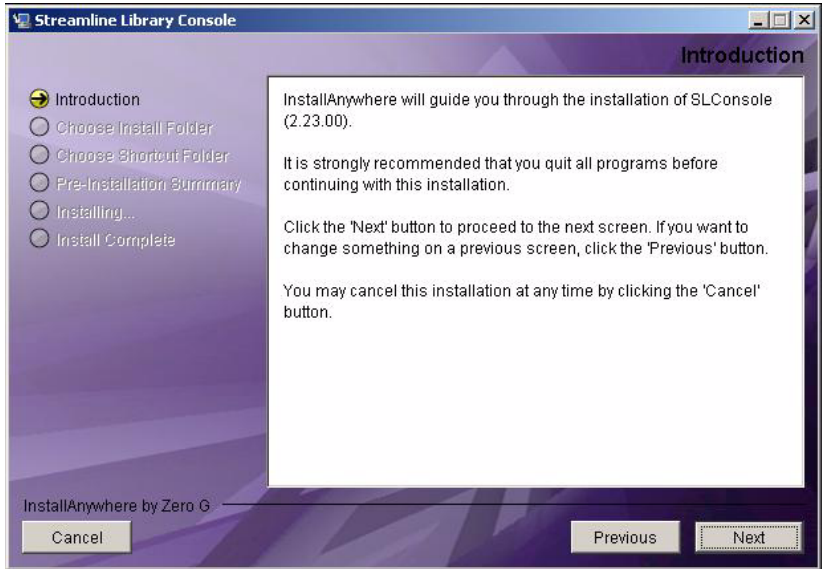

3. Review the information, and click Next.

The Choose Install Folder screen appears.

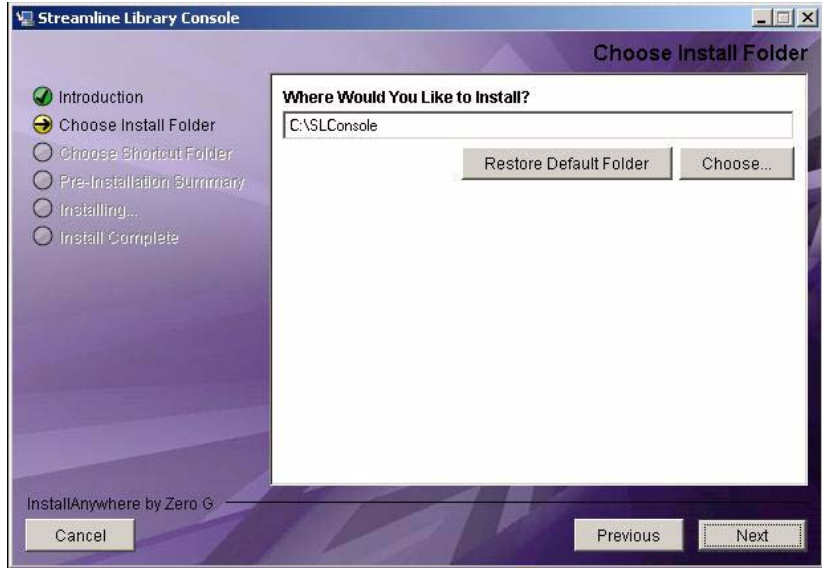

4. Enter the location where you want to install the file, and click Next. The **Choose Shortcut Folder** screen appears.

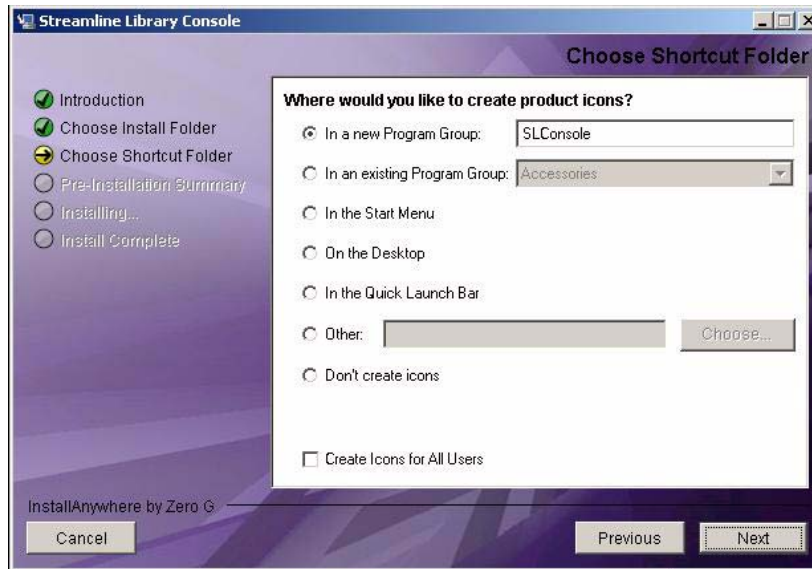

5. Enter the location where you want to create the shortcut icon, and click Next.

---

**Note** – On Solaris, the default location for shortcuts is the user’s home directory. However, shortcuts cannot be created in /, which is the root user’s home, so if you are installing on a Solaris platform as root you must choose something other than the default location. In this case, it is recommended that you choose /usr/bin or a similar location.

---

The **Pre-Installation Summary** screen appears.

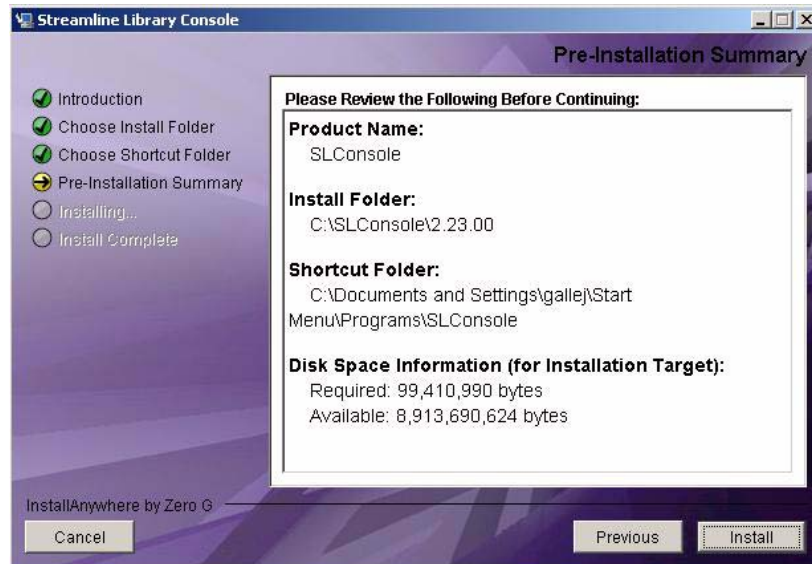

**6. Review the information, and click Install.**

The installation begins, and the **Installing SL Console** screen appears.



When the installation finishes, the **Install Complete** screen appears.

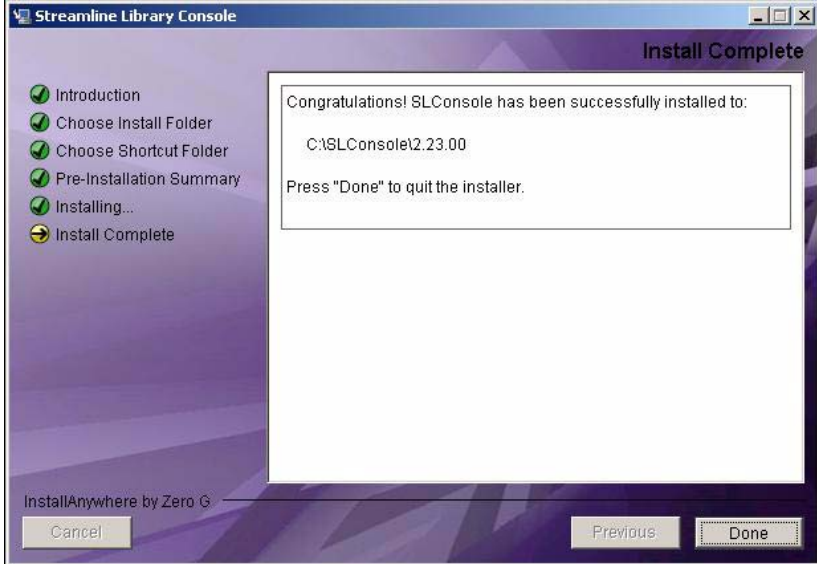

**7. Review the information and click Done to exit the installation program.**



## SL3000 Automated Library Operations

---

### Automated Mode of Operation

When in automated mode of operation, the library automatically mounts and dismounts cartridges without physical intervention by a person.

Automated operations include the following activities:

- Mounting and dismounting cartridges
- Entering and ejecting cartridges through a rotational or optional AEM CAP
- Logging library events
- Drive cleaning

### Cartridge Mount and Dismount Activities

The primary function of the library is the automated mounting and dismounting of cartridges. Host mount and dismount commands are accepted by the library controller and translated into robotic commands that are performed by the TallBots.

### Mount Sequence

A simplified mount sequence involves the following steps:

1. A host requests that a specific volume serial number (VOLID or volser) be mounted in a drive.
2. The library controller transmits to the host that the VOLID is located within the library and a drive is available to satisfy the mount request.
3. The library assumes responsibility for the mount.
4. The host command is translated by the library controller into motion commands for the TallBot.
5. The cartridge is taken from its storage cell and placed in the drive.

6. The library returns status to the host that the mount operation is completed.
7. The drive performs the read/write activity directed by the host.

## Dismount Sequence

A simplified dismount sequence involves the following steps:

1. A host requests that a specific VOLID be dismounted from a drive.
2. The library controller transmits to the host that the VOLID is located in the drive and the library is available to satisfy the dismount request.
3. The library assumes responsibility for the dismount.
4. The host command is translated by the library controller into mechanical commands for the TallBot.
5. The cartridge is taken from the drive and placed into its home cell.
6. The library returns status to the host that the dismount operation is completed.

## Determining When the Library is Not in Automated Mode

The library is not in automated mode when it is not able to accept host requests. The following conditions indicate that the library is not in automated mode:

- A library main access door is open.
- The TallBot does not automatically mount and dismount cartridges.
- The device tree in the SL Console indicates that there is a problem with the library.

# Library and Device Status

The SL Console screen displays health indicators for each of the following devices:

- Library
- Drives
- Rotational and AEM CAPs
- Power supplies
- Robots(s)
- AEM safety doors

The screenshot shows the SL3000 System Detail console. On the left is a tree view of the system hierarchy. On the right is a detailed view of a selected drive.

**Tree View (Left):**

- Library:1,0,0,0,0 (Warning icon)
- CAP Folder:1,0,0,0,0 (Green checkmark)
  - CAP:1,1,-2,2,0 (Green checkmark)
  - CAP:1,1,5,2,0 (Green checkmark)
- Drive Folder:1,0,0,0,0 (Warning icon)
  - Drive:1,1,-1,1,2 (Green checkmark)
  - Drive:1,1,-3,1,2 (Green checkmark)
  - Drive:1,1,-4,1,2 (Green checkmark)
  - Drive:1,1,2,1,2 (Green checkmark, circled 4)
  - Drive:1,1,4,1,1 (Warning icon)
- Power Supply Folder:1,0,0,0,0 (Green checkmark)
  - Power Supply:1,0,0,1,1 (Green checkmark)
  - Power Supply:1,0,0,1,17 (Green checkmark)
  - Power Supply:1,0,0,1,18 (Green checkmark)
  - Power Supply:1,0,0,1,23 (Green checkmark)
  - Power Supply:1,0,0,1,24 (Green checkmark)
  - Power Supply:1,0,0,1,27 (Green checkmark)
  - Power Supply:1,0,0,1,29 (Green checkmark)
  - Power Supply:1,0,0,1,6 (Green checkmark)
  - Power Supply:1,0,0,1,7 (Green checkmark)
- Robot Folder:1,0,0,0,0 (Green checkmark)
  - Robot:1,1,0,1,0 (Green checkmark)
  - Robot:1,1,0,2,0 (Green checkmark)

**Drive Detail View (Right):**

Drive: [selected drive]







State

Transition Request	-select-transition-
Health State	warn
Device State	Not Ready
Access State	offline
Drive State	empty
Drive needs cleaning	false
Drive Last Cleaned	Unknown
Host Activity	false

At the bottom of the console, there are three status indicators:

- 1: Comm Status (Green checkmark)
- 2: UserID: root
- 3: Library:crimson20.stortek.com (Warning icon)

The following table describes the health monitor indicators.

	<b>Indicator</b>	<b>Description</b>
1	Comm Status	<p>Current status of the communication channel between the SL Console and the library controller. Possible icons are:</p> <p> Normal communications. The heartbeat monitor flashes periodically when the SL Console is communicating normally with the library controller.</p> <p> A warning. This icon appears when the server response takes longer than 10 seconds.</p> <p> An error. This icon appears when the server response takes longer than 30 seconds.</p>
2	Userid	Userid currently logged in to the SL Console.
3	Library	<p>Library to which the SL Console is connected, and a graphical representation of the current health of the library and its devices. Possible icons are:</p> <p> All library devices are functioning normally.</p> <p> A warning. One or more devices in the library is offline or operating in a degraded state.</p> <p> An error. One or more devices in the library has experienced a failure.</p>
4	Device health icon	Current status of the indicated device. If a device type indicator is yellow or red, you can expand the device folder to display the individual device health icons and then display details on the specific devices that are experiencing abnormal conditions.

The library health indicator (3) also reflects status alerts, which are messages about significant issues with the library firmware or configuration status. These messages can be displayed and managed on the **Status Module** screen, if the Service license is active on the library. See [“Status Alert Messages” on page 78](#) for details.

If there are multiple problems with a device or status alert conditions, the health indicator reflects the one that is most severe. For example, if a license is due to expire (a “yellow” condition) and a CAP has experienced a failure (a “red” condition), the library health indicator will be red. Fixing the CAP problem will cause the library health indicator to change to yellow. The indicator will not return to green until the license issue has also been resolved or the alert message cleared manually.

## Communications Failures

If the SL Console loses communication with the library controller, after about 30–60 seconds, the heartbeat monitor turns gray, then red, and the following error message appears:

Heartbeat message not received from the library controller.

You must log off from the SL Console and then log on again to restore communication.



---

# Library Reports

The library reports provide information on the library and its associated devices (for example, drives, robots, and CAPs), events, and tape cartridges. You can use the library reports to monitor library activity and identify potential problems. In addition to displaying the reports on-screen, you can save the report data to a file, which you can then print or include in e-mail.

All report output is a static display of information sent from the library controller at the time the report is generated. The SL Console does not update the information dynamically unless you explicitly select the **Update** button on the Options bar.

---

**Note** – Running multiple instances of the standalone SL Console or Web-launched SL Console on the same PC or workstation can cause problems such as inconsistent data on reports. It is recommended that only one user at a time produce SL Console reports on a PC or workstation, unless all instances of the SL Console are the same version.

---

## Report Types

The SL Console provides the following types of reports:

- Log – detailed system event logs
- Statistics – statistical information on library operations
- Status Detail – details on the status of the library and associated devices, such as CAPs, drives, and robots
- Status Summary – summary information on the status of the library and associated devices
- Version – details about library hardware and software versions

## Report Options Bar

The Options bar on each report allows you to perform the following functions:

- [Search a Library Report](#)
- [Update the report with current data](#)
- [Save Library Report Data to a File](#)

---

# Status Alert Messages

---

**Note** – This feature is available only if the Service license is active on the library.

---

The library Status Module provides a centralized mechanism for displaying and managing library status alerts, which are messages about significant issues with the library firmware or configuration. Status alerts also appear in the library Event Log, but they may become “buried” in the volume of messages there. The **Status Module** screen highlights significant messages, making it easier for you to identify and resolve certain problems.

Following are examples of status alert messages that may appear on the Status Module screen:

- Redundant robots have been installed, but the Dual Robot license is not active
- A licensed feature is due to expire
- An invalid partition configuration has been detected

The **Status Module** screen does not include messages about device issues, because details about them are displayed in the respective device status screens (**CAP Status**, **Drive Status**, etc.)

A status alert message also causes the library health indicator to change to yellow or red, depending on the severity of the issue. See [“Library and Device Status” on page 75](#) for details.

See the following procedures for details about managing status alert messages:

- [“Display Library Status Alerts” on page 102](#)
- [“Clear Library Status Alerts” on page 104](#)

---

# CAP Operations

---

**Note** – This section describes general CAP activities applying to all libraries. For information specific to CAP activities in partitioned libraries, see [“Partitions and Rotational and AEM CAPs” on page 275](#).

---

---

**Note** – Most CAP functions described in this section apply to AEMs as well as regular CAPs. In cases where there is a distinction between the two, the term “rotational CAP” is used to refer to regular CAPs.

---

CAPs (cartridge access ports) allow a library operator to enter or eject cartridges to or from the library. You can use the CAPs only when the library is in automated mode.

## Rotational CAPs

One rotational CAP is always present in the base module. Optionally, the drive expansion module and cartridge expansion module can also each have one rotational CAP.

Each rotational CAP contains two removable 13-slot magazines, allowing for a total of 26 cartridges to be imported or exported at one time through each CAP.

## AEM CAPs

See [“AEM Operations” on page 84](#) for a detailed description of AEM CAPs.

## CAP Open Sequence

Opening a rotational or AEM CAP involves the following steps:

1. A host issues a command to unlock the CAP.
2. The CAP status is updated to “unlocked.”
3. The library operator presses the CAP button.
4. The CAP status is updated to “open.”
5. For rotational CAPs, the CAP motor is activated, and the CAP rotates outward to expose the magazines (rotational CAPs).

For AEM CAPs, once the **Enter** LED is illuminated, the library operator can lift the latch and open the AEM access door (AEM CAPs).

## CAP Close Sequence

Closing a rotational or AEM CAP involves the following steps:

1. For rotational CAPs, the library operator presses the CAP button on the key pad. The CAP motor is activated, and the CAP rotates inward to close the CAP.  
For AEM CAPs, the library operator closes the AEM access door and secures the latch.
2. The library operator presses the CAP button to start the close sequence.
3. The CAP status is updated to "closed" and "locked."
4. The TallBot audits all CAP slots.

## CAP Auto Enter Mode

---

**Note** – CAP auto enter mode applies only to HLI libraries; it is not supported in FC-SCSI libraries.

---

CAP auto enter mode allows a library operator to open a rotational or AEM CAP and initiate an enter operation without issuing an explicit enter request and without an explicit reservation from a host application. When in auto mode, a CAP is left unlocked and its LED is lit. The CAP is locked only during cartridge enter, eject, or audit operations.

Auto enter mode is managed by the host applications. See the appropriate tape management software documentation for details. To place a CAP in auto enter mode, you must enter the appropriate tape management command to unlock the CAP.

To initiate an enter operation using an automatic CAP, you only need to press the **CAP Open** button on the key pad. Auto enter mode does not affect CAP operations for ejecting cartridges, so you must always issue an explicit eject command to eject cartridges through the CAP.

## Manual CAP Mode

Manual mode is the most secure method of CAP operations.

When in manual mode, a rotational or AEM CAP is locked by default and its LED is not lit. To initiate an enter or eject operation using a manual CAP, you must enter an explicit enter or eject request before pressing the CAP Open button on the key pad.

## CAP States

A CAP must be unlocked in order for you to open it to insert or remove cartridges. When a CAP is unlocked, the light on the CAP button is turned on.

When you close a CAP, the TallBot performs an audit to determine whether there are cartridges present. During the audit the CAP is locked and the light on the CAP button is turned off. Once the audit is completed, the CAP is returned to its default state.

The following table describes the default states of the various types of CAPs within a non-partitioned library.

Type of CAP	Default State	Default CAP Button Light Condition
HLI – manual mode	Locked	Off
HLI – auto enter mode	Unlocked	On
FC-SCSI	Locked	Off

## CAP Assignment Mode

---

**Note** – This feature is available starting with SL3000 firmware version FRS\_2.33 and SL Console version FRS\_4.47.

---



---

**Note** – This feature applies only to libraries with FC-SCSI host connections; it is not applicable to libraries that have only HLI (TCP/IP) host connections.

---



---

**Note** – This feature applies to non-partitioned libraries only.

---

The CAP assignment mode controls whether library CAPs can be used for normal host operations or for diagnostic moves. A common use of diagnostic moves is to move cleaning or diagnostic cartridges from a CAP to a reserved (system) cell. See [“Managing Automatic Cleaning Through the SL Console” on page 92](#) for details.

Prior to performing a diagnostic move to or from a CAP, you must change the library CAP assignment mode to “diagnostics”. This makes all library CAPs unavailable to library hosts and available to SL Console control. For detailed instructions on setting the CAP assignment mode, see [“Change the CAP Assignment Mode for an FC-SCSI Library” on page 138](#).

## CAP Priorities for Cartridge Ejects by FC-SCSI Hosts

When you initiate an eject operation from an HLI host, you are able to specify the CAP to use. The SCSI interface, however, does not provide this level of control. The interface essentially aggregates all CAPs and AEMs in the library and treats them as one large CAP. When you initiate an eject operation from an FC-SCSI host, the TallBot places cartridges in CAPs, working from left to right, starting first with rotational CAPs, and then moving to AEMs, if applicable.

For example, assume an FC-SCSI library with the following configuration:

- Base module, with standard rotational CAP

- Two CEMs, with optional rotational CAPs
- Two AEMs

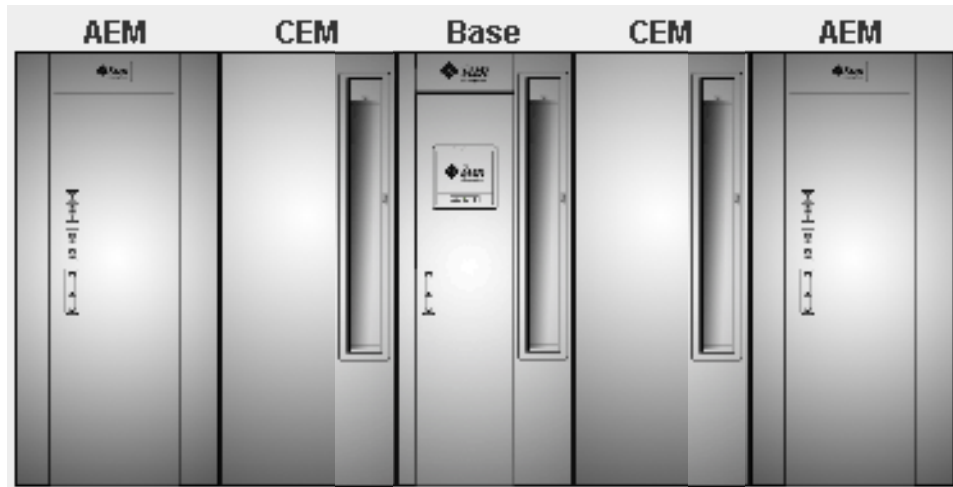

---

**Note** – The following example assumes either a non-partitioned library, or a partitioned library in which all CAPs and AEMs are shared by all hosts. For partitioned libraries, the CAP priority is dependent on how CAPs are allocated to partitions.

---

For an eject operation of 350 cartridges, the TallBot would fill CAP cells in the following order:

	<b>Module</b>	<b>Number of Cartridges</b>	<b>Total Cartridges</b>
1	Left CEM	26	26
2	Base Module	26	52
3	Right CEM	26	78
4	Left AEM	234	312
5	Right AEM	38	350

## Using CAPS in a Partitioned Library

---

**Note** – This topic applies to partitioned libraries only. See [“Partitioning Task Summary” on page 285](#) for details about defining library partitions.

---

A rotational or AEM CAP is a shared library resource – that is, it can be used by all partitions in the library. A CAP can be used by only one partition at a time, however. While a partition is using a CAP for enters or ejects, the CAP is reserved to that partition and unavailable to all others.

In order for a partition to reserve a CAP, all of the following conditions must be met:

- The CAP must be available – that is, not reserved by any other partition.

- The CAP must be empty.
- The CAP must be closed and locked.

For additional details, see [“CAP “Ownership””](#) on page 256.

## Additional CAP Information

See the following sections of this manual for complete details about rotational and AEM CAPs.

<b>Section</b>	<b>Type of Information</b>	<b>Page</b>
<a href="#">“AEM Operations”</a>	Usage information that applies specifically to AEM CAPs	<a href="#">84</a>
<a href="#">“Rotational and AEM CAP Management Tasks”</a>	Procedures for displaying CAP status and properties	<a href="#">126</a>
<a href="#">“Cartridge Management Tasks”</a>	Procedures for using CAPs to load and unload cartridges	<a href="#">140</a>
<a href="#">“Partitions and Rotational and AEM CAPs”</a>	Partition configuration information relating to CAPs	<a href="#">275</a>

---

# AEM Operations

The AEM (access expansion module) allows a library operator to perform bulk loads or unloads of up to 234 cartridges at a time to or from the library. The AEM also allows for non-disruptive maintenance of a library TallBot.

---

**Note** – AEMs share many of the same features and functions as rotational CAPs, but they also have some unique characteristics. This section describes what is unique to AEMs.

---

## AEM Access Door

The AEM access door is the external door you open to bulk load or unload cartridges to or from the library. The front panel of the access door includes the following components:

- Three LEDs: Wait, Enter, and Unlocked
- Two locks:
  - Service Access – Can be opened only by a Sun StorageTek CSE. Opening this lock releases the access door deadbolt.
  - Deadbolt Override – For “fast access” to the inside of the AEM by a library operator. This action has the same effects on library operations as opening the main library access door.
- “Operator Request CAP” button – For normal access to the inside of the AEM, to load or unload cartridges. Pressing this button releases the access door deadbolt.
- Latch – Opens and closes the access door. The latch can be opened only after you release the deadbolt or use the deadbolt override.

## AEM Safety Door

The safety door is the internal “garage” door, which lowers to separate the AEM from the rest of the library. This door allows for safe access to the inside of the AEM, either for a library operator to load or unload cartridges, or for a Sun StorageTek CSE to perform service on the TallBot or other AEM components.

The safety door is lowered when you press the “Operator Request CAP” button on the AEM access door or when a Sun StorageTek CSE uses the Service Access lock. The safety door is not lowered if you perform an AEM “fast access” by unlocking the Deadbolt Override lock.

The safety door is automatically raised when you close the AEM access door. The TallBot then enters the AEM and conducts an audit of all AEM cells. A full audit of an AEM should take less than three minutes.



## AEM CAP Functions

Each AEM CAP contains 18 removable 13-slot cartridge magazines on the front and back walls, for a total of 234 cartridge slots. The magazines are arranged in a 3 X 3 configuration on each wall. The magazines are the same as those used in rotational CAPs.

In terms of cartridge loads and unloads, the library controller treats each AEM as a very large CAP. See [“CAP Operations” on page 79](#) for information on CAP functions that apply to AEMs.

## Partitions and AEMs

With regard to library partitioning, AEM CAPs are subject to the same rules and restrictions as rotational CAPs. They can be allocated for exclusive use by one partition, or they can be shared by multiple partitions with the same host interface type. See [“Partitions and Rotational and AEM CAPs” on page 275](#) for details.

## Non-disruptive Maintenance

The AEM allows a Sun StorageTek CSE to safely access and service a library TallBot without having to take the library offline. If a TallBot is defective, it parks itself in the AEM. The library remains online, and if redundant TallBot are installed, the library can continue normal operations through the remaining functional TallBot.

A Sun StorageTek CSE can use a special key to unlock the Service Access lock on the access door. This causes the AEM safety door to lower, sectioning off the AEM from the rest of the library. Once the safety door is fully down, the Sun StorageTek CSE can open the AEM access door and safely perform maintenance on the defective TallBot or other AEM components, while the library remains online. The AEM itself is taken offline during the maintenance period, causing cartridge load/unload functions to be suspended.

When maintenance is complete, the StorageTek CSE closes the access door, the safety door raises, the TallBot is re-initialized and performs an audit of the AEM CAP cartridge slots, and then the AEM is brought back online.

## Additional AEM Information

See the following sections of this manual for complete details about AEMs.

Section	Type of Information	Page
<a href="#">“CAP Operations”</a>	Usage information that applies to both rotational CAPs and AEM CAPs	79
<a href="#">“Rotational and AEM CAP Management Tasks”</a>	Procedures for displaying AEM CAP status and properties	126
<a href="#">“Cartridge Management Tasks”</a>	Procedures for using AEM CAPs to load and unload cartridges	140

<b>Section</b>	<b>Type of Information</b>	<b>Page</b>
<a href="#">“AEM Safety Door Management Tasks”</a>	Procedures for displaying status and properties of the AEM safety door (“garage” door)	<a href="#">198</a>
<a href="#">“Partitions and Rotational and AEM CAPs”</a>	Partition configuration information relating to both rotational and AEM CAPs	<a href="#">275</a>
<a href="#">“AEM Safety Door Utility Tasks”</a>	Procedures for rebooting the AEM safety door (“garage” door)	<a href="#">471</a>
<a href="#">“Manual Operation Tasks”</a>	Procedures for “fast access” to the AEM	<a href="#">478</a>
<a href="#">FIGURE B-5, “Access Expansion Module Walls” on page 514</a>	Detailed diagram of the wall layouts	<a href="#">514</a>

---

# Cartridge Management

All library cartridges must have a readable external label. See [Appendix C, “Cartridge Handling”](#) for details.

The HSC and ACSLS host software applications do not support unlabeled cartridges and will not allow them to be entered through the CAP. If you place an unlabeled cartridge in a CAP, the host leaves it there and you must remove it from the CAP.

If you place an unlabeled cartridge into a storage cell manually, the TallBot leaves it there during a hardware audit and does not attempt to place another cartridge into the slot. During an ACSLS or HSC audit, however, the host moves the cartridge to the CAP for ejection from the library.

The library controller will not allow you to mount an unlabeled or unknown type cartridge into any tape drive.

## Entering Cartridges

You can enter up to 26 cartridges at one time through each rotational CAP. You can bulk load up to 234 cartridges through each AEM CAP.

Before entering a cartridge into the library, you must verify that it is labeled properly. Insert each cartridge in a CAP slot so that the customer label (if present) is facing you, the hub gear is facing down, and the cartridge label is facing you. Cartridges may be placed in any CAP slot, in any order; the TallBot audits all CAP slots when the CAP door is closed.

---

**Note** – The CAP design prevents you from placing a T9x40 or T10000 cartridge in the CAP, upside-down. It does not, however, prevent you from placing an LTO cartridge in the CAP upside-down.

---

The TallBot’s bar-code scanner reads cartridge labels only during enter operations, since the VOLIDs are new and must be added to the library controller database. The TallBot does not need to read cartridge labels during ejects.

When a cartridge is entered into the library, it is either assigned a home cell by the host or mounted on a drive, depending on the reason why it was entered. The location of a stored cartridge is recorded in the library controller database, using the library internal address format (see [“Library Internal Address” on page 493](#)). The location is also transmitted to the host for inclusion in the host’s cartridge database.

## Ejecting Cartridges

You can eject up to 26 cartridges at one time through each rotational CAP. You can bulk unload up to 234 cartridges through each AEM CAP.

To eject a cartridge, you must specify the VOLID of the cartridge you want to remove from the library. The TallBot moves to the storage location indicated in the library controller database, removes the cartridge from the slot, and places the cartridge in a

CAP slot. See [“CAP Priorities for Cartridge Ejects by FC-SCSI Hosts” on page 81](#) for details on the order in which CAPs are used in FC-SCSI libraries. After the CAP is opened, the cartridge and its location are deleted from the library controller database and the host database.

---

**Note** – The TallBot does not read cartridge labels during eject operations.

---

## Locating Cartridges

The SL Console allows you to display the library internal address of any cartridge. You can locate a cartridge based on any of the following criteria:

- VOLID – See [“Locate a Cartridge by VOLID” on page 157](#) for details.
- Library internal address – See [“Locate a Cartridge by Address” on page 159](#) for details.
- Host address (FC-SCSI or HLI) – See [“Locate a Cartridge by Address” on page 159](#) for details.

This utility is especially useful when you need to perform a manual mount of a cartridge. The library management software (HSC or ACSLS) provides the VOLID and the HLI-PRC or FC-SCSI address of the cartridge and the drive bay address of an available drive. Before you enter the library, write down the VOLID, cartridge location, and the drive slot location.

## Barcode Presentation

---

**Note** – This feature is available starting with SL3000 firmware version FRS\_2.33 and SL Console version FRS\_4.47.

---



---

**Note** – This feature applies only to libraries with FC-SCSI host connections; it is not applicable to libraries that have only HLI (TCP/IP) host connections.

---

The barcode presentation feature allows you to specify which part of a standard cartridge barcode the library passes to FC-SCSI host applications.

Standard cartridge barcodes are eight characters in length, in 6+2 format, where:

- The first six characters indicate the unique volume ID (VOLID). For example, “NGD084”.
- The last two characters indicate the media type and domain. For example, “L1” for LTO Gen 1 or “T1” for T10000. These characters are referred to as the media/domain suffix.

Normally the library passes only the six VOLID characters to a host. This applies to both HLI and FC-SCSI connections. Some FC-SCSI host applications, however, may need the full eight-character barcode in order to uniquely identify a cartridge. The barcode presentation feature supports this requirement by allowing you to configure the library or partition to provide this information in all library/host communications.

This feature does not affect how cartridge labels are displayed in library reports and screens. Nor does it affect which part of the label you must use when submitting a request through the SL Console or CLI. The full eight-character barcode is always used in these cases.

For detailed instructions on setting the barcode presentation feature, see the following procedures:

- [“Configure Barcode Presentation in a Non-Partitioned FC-SCSI Library” on page 147](#)
- [“Configure Cartridge Barcode Presentation for an FC-SCSI Partition” on page 149](#)

## Recovery Moves

Using the recovery move diagnostic function, you can move a cartridge from one location to another. For example:

- You can return a cartridge to its original location from a CAP cell, drive, or another storage cell location.
- You might decide to group cartridges by data type or to move them closer to their assigned drives.
- You can eject a cleaning or diagnostic cartridge that has expired.
- You can enter a new cleaning or diagnostic cartridge and move it to a reserved storage cell.

A cartridge currently in a storage cell can be moved only to a CAP, a reserved cell, or another storage cell, not to a drive. A cartridge currently in a drive, CAP, or reserved cell can be moved to any other unoccupied location in the library. See the following procedures for complete details:

- [“Move a Specified Cartridge by VOLID” on page 161](#)
- [“Move a Cartridge From a Specified Location” on page 163](#)

Before moving any cartridge, it is helpful to display or print a report showing where cartridges are currently located and which storage cells are unoccupied. See one of the following procedures for detailed instructions:

- [“List Library Cartridges” on page 154](#)

## Cartridge Management Procedures

For detailed cartridge management procedures, see [“Cartridge Management Tasks” on page 140](#).

---

## Drives

You can install up to 56 drives within one library, as follows:

- Up to 24 in the Base Module
- Up to 32 in a drive expansion module (DEM)

See [“Tape Drives” on page 17](#) for a list of supported tape drives.

## Drive Identification

The library uses the following addressing schemes for each library drive:

- Library internal address – For all drives. Assigned by the library controller based on the library, rail, column, side, and row location of the drive.
- HLI-PRC address (Host LMU Interface-Panel, Row, Column) – For TCP/IP host connections only. Assigned by host applications.
- Host SCSI element address – For FC-SCSI host connections only. Assigned by host applications.
- Drive bay address – For all drives. Assigned by the library controller based on the physical slot in which the drive is installed.
- dynamic World Wide Name – For Fibre Channel connections only. Assigned by the library controller, according to the slot into which the drive is installed.

See [Appendix A, “Library Resource Addresses” on page 491](#) for details on drive identification and addressing schemes.

## Drive States

A drive can be in either of the following states:

- Online – The drive is available for read/write operations.
- Offline – The drive is not available for read/write operations.

## Drive Management Procedures

For detailed drive procedures, see [“Drive Management Tasks” on page 167](#).

---

# Drive Cleaning

The library tape drives require periodic cleaning to prevent read and write errors. The library supports two methods of drive cleaning:

- [Managing Automatic Cleaning Through the SL Console](#)
- [Manual Cleaning](#)

## Cleaning Cartridges

---

**Note** – You must use cleaning cartridges whose media types are compatible with the drive types in the library.

---

Cleaning cartridges have a limited life span. Refer to your tape drive publications to determine the maximum usage count, or threshold, for each type of cleaning cartridge.

When you enter a cleaning cartridge into the library, the library controller considers the cartridge to be new and sets the usage count to zero. It is therefore important to enter only new cleaning cartridges into the library.

Whenever a cleaning cartridge is used to clean a drive, its usage count is incremented. When a cleaning cartridge's usage count exceeds its threshold, the cartridge must be replaced.

You can use the SL Console to display the status of a cleaning cartridge at any time. The following statuses are possible:

- OK – The cartridge is still within the threshold.
- Warning – The cartridge has reached the threshold.
- Expired – The cartridge has exceeded the threshold.

## Ejecting Expired Cleaning Cartridges

You must use care when ejecting expired cleaning cartridges from the library. If you move an expired cleaning cartridge to a CAP, it will remain there until you open the CAP and remove the cartridge. If you leave the cartridge in the CAP, it could inadvertently be re-entered into the library by another user.

## Managing Automatic Cleaning Through the SL Console

---

**Note** – This feature applies only to libraries with FC-SCSI host connections; it is not applicable to libraries that have only HLI (TCP/IP) host connections.

---

The SL3000 automatic cleaning function (or “auto clean”) allows you to manage automatic drive cleaning through the SL Console. This function should be enabled only for partitions or whole libraries controlled by FC-SCSI hosts.

For all other partitions and whole libraries—those controlled by the ACSLS or HSC tape management software—you should disable the automatic cleaning function in the SL Console. (See [“Configure Drive Auto Clean” on page 181](#) for details.) ACSLS or HSC will manage the automatic cleaning function for these partitions and libraries, and the SL3000 automatic cleaning function prevents HSC and ACSLS from being notified when drives need cleaning. See the ACSLS and HSC documentation for details.

When auto clean is enabled, the library controller automatically initiates a cleaning operation whenever a drive requires cleaning. The TallBot retrieves an appropriate cleaning cartridge (based on drive type) from the reserved cells, mounts the cartridge onto the drive, and returns the cartridge to its assigned storage cell after cleaning is complete.

### Importing and Exporting Cleaning Cartridges

The SL3000 automatic cleaning function does not support the following functionality:

- Automatic importing of cleaning cartridges through the CAP and placement of these tapes within the reserved cells dedicated for cleaning and diagnostic cartridges.
- Automatic exporting of expired cleaning cartridges through the CAP.

You must perform these functions manually. See the following sections for detailed information:

- [“Enter Cleaning or Diagnostic Cartridges” on page 183](#)
- [“Eject Cleaning or Diagnostic Cartridges” on page 184](#)
- [“CAP Assignment Mode” on page 81](#)

## Manual Cleaning

---

**Note** – Manual drive cleaning is initiated through the library management software. Refer to the ACSLS or HSC documentation for command syntax.

---

If auto clean is disabled, you must initiate drive clean operations manually. To verify whether a drive needs cleaning, you can use the SL Console to display a drive’s cleaning status and the date when it was last cleaned.

If auto clean is enabled, you may still be able to initiate a manual clean, depending on the drive type. Some drive types allow manual cleaning at any time, while others do not allow cleaning to be initiated unless a usage threshold has been met. In the latter



case, the library may allow you to mount a cleaning cartridge on a drive, but the drive will not actually perform the cleaning operation. Refer to your tape drive publications for details.

To locate the correct type of cleaning cartridge for a particular drive, you can use the SL Console to generate a cartridge summary and drive details report.

## Drive Cleaning Procedures

For detailed drive procedures, see [“Drive Cleaning Tasks”](#) on page 180.

---

## TallBots

The library TallBot moves cartridges throughout the library storage slots, tape drives, and CAPs. It also performs audits of the library.

The TallBot is included with the Base Module and is accessible from the front of the rack. The three main components of the TallBot are:

- X table assembly – Provides 180-degree lateral motion.
- Z drive assembly – Provides vertical motion.
- Hand assembly – Includes the following components:
  - Grippers to carry cartridges.
  - Laser bar-code scanner to calibrate position and read cartridge labels.
  - Proximity sensor to detect empty storage cells and unlabeled cartridges.

See [“Robot and Power Supply Tasks” on page 188](#) for details about displaying and managing TallBot status and other information.

## SCSI FastLoad Feature

---

**Note** – This feature is available starting with SL3000 firmware version FRS\_2.33 and SL Console version FRS\_4.47.

---

---

**Note** – This feature applies only to libraries with FC-SCSI host connections; it is not applicable to libraries that have only HLI (TCP/IP) host connections.

---

SCSI FastLoad is an optional feature which can enable faster mount/dismount operations for libraries or partitions with FC-SCSI host connections.

Normally with the SCSI interface, a cartridge mount is considered complete only when the drive indicates that it is ready for read/write operations. This can result in the TallBot standing idle for several seconds between mount/dismount requests while it waits for the cartridge to load and thread in the drive.

When SCSI FastLoad is enabled, a cartridge mount is considered complete as soon as the drive indicates that it has accepted the cartridge. As soon as the TallBot puts the cartridge in the drive, the TallBot is released and the library returns a success status to the host. The TallBot is immediately available to process the next library request.

The advantage of the FastLoad feature is that it allows for faster mount/dismount activity in the library. However, if a cartridge fails to load after the TallBot has been released, it is up to the FC-SCSI host to force a dismount of the cartridge.

In a partitioned library, the FastLoad feature can be enabled or disabled separately for each FC-SCSI partition.

For detailed instructions on enabling the FastLoad feature, see the following procedures:

- [“Configure SCSI FastLoad in a Non-Partitioned Library” on page 189](#)

- [“Configure SCSI FastLoad for a Partition”](#) on page 191

## TallBot Procedures

For detailed TallBot procedures, see [“Robot and Power Supply Tasks”](#) on page 188.

## Power Supplies

The SL3000 provides full redundancy for tape drives, robotics units, and electronics. The following redundancy options are available:

- N+1
- 2N
- 2N+1

The following power source options are available:

- 120–127 VAC, single phase
- 200–240 VAC, single phase

See [“Power Options” on page 22](#) for additional details.

## Power Supply Procedures

For detailed power supply procedures, see [“Robot and Power Supply Tasks” on page 188](#).

---

## Host Interface Type

The SL3000 supports the following control path interface options:

- HLI (TCP/IP) – TCP/IP protocol using Ethernet 10/100 Base-T and CAT-5 cables
- FC-SCSI – SCSI-3 protocol and command set over a physical Fibre Channel interface

See [“Library Control Path” on page 24](#) for details.

## Non-Partitioned Libraries

In non-partitioned libraries, all hosts must use the same interface type to connect to the library.

You can display the interface type on the **System Detail > Status > General** screen.

You can change the interface type through the [Select Active Cells > Select Active Cells](#) screen.

## Partitioned Libraries

In partitioned libraries, both the FC-SCSI and HLI host interface types can be used; each partition must use one or the other. When you create a new partition, you specify which interface type it uses. All hosts within a partition use the same interface type.

For complete details, see [“Host-Partition Connections” on page 269](#).

## Special Configuration Options for FC-SCSI Libraries

The **Library Configuration** screen provides the following configuration options which apply only to FC-SCSI libraries. In partitioned libraries, these options can be configured separately for each partition.

### SCSI FastLoad

This feature controls the criteria by which cartridge mounts are considered complete. Options are:

- **Checked** – Turns SCSI FastLoad on. A cartridge mount is considered complete as soon as the drive indicates that it has accepted the cartridge.
- **Unchecked** – Turns SCSI FastLoad off. A cartridge mount is considered complete only after the cartridge has been loaded and threaded in the drive and the drive indicates that it is ready for read/write operations. This is the default setting.

See the following sections for details:

- [“SCSI FastLoad Feature” on page 94](#)

- “Configure SCSI FastLoad in a Non-Partitioned Library” on page 189
- “Configure SCSI FastLoad for a Partition” on page 191

## Barcode Presentation

This feature controls which part of a cartridge barcode the library passes to FC-SCSI host applications. Options are:

- all – All eight barcode characters are passed to host applications.
- left6 – Only the six VOLID characters, which are on the left side of the barcode, are passed to host applications. The domain and type characters, which are the two characters on the right, are not passed. This is the default setting.

See the following sections for details:

- “Barcode Presentation” on page 88
- “Configure Barcode Presentation in a Non-Partitioned FC-SCSI Library” on page 147
- “Configure Cartridge Barcode Presentation for an FC-SCSI Partition” on page 149

---

# Automated Operation Tasks

Library automated operation tasks are divided into the following categories:

- “Library Management Tasks” on page 100
- “Rotational and AEM CAP Management Tasks” on page 126
- “Cartridge Management Tasks” on page 140
- “Drive Management Tasks” on page 167
- “Drive Cleaning Tasks” on page 180
- “Robot and Power Supply Tasks” on page 188
- “AEM Safety Door Management Tasks” on page 198

---

# Library Management Tasks

<b>Task</b>	<b>Page</b>
Display Library Status	101
Display Library Status Alerts	102
Clear Library Status Alerts	104
Display FC-SCSI Port Status	107
Display Library Configuration Information	108
Display Library Controller Properties	109
Display Drive Controller Properties	110
Display Drive Controller Properties	110
Change the Library Interface Type (Non-Partitioned Libraries)	111
Display a Library Report	114
Search a Library Report	116
Save Library Report Data to a File	118
Display the "Last 24 Hours" Library Energy Monitor Report	120
Display the "Last Month" Library Energy Monitor Report	122
Display the "Last Year" Library Energy Monitor Report	124



## ▼ Display Library Status

View the current operational state of the library. These values are updated whenever there is host activity, background operations, or operator activity.

**Note** – This information is also available through **Reports > Library Details**. See [“Display a Library Report”](#) on page 114 for detailed instructions.

1. Select **Tools > System Detail**, and click the **Library** folder.
2. Click the **Status** tab, and then the **General** tab.

The screen displays the current status of the library.

The screenshot shows the 'System Detail' window for a library. The left sidebar lists the library and its components: Library:1,0,0,0,0 (with a warning icon), CAP Folder:1,0,0,0,0 (with a warning icon), Drive Folder:1,0,0,0,0 (with a checkmark), Power Supply Folder:1,0,0,0,0 (with a checkmark), Robot Folder:1,0,0,0,0 (with a checkmark), and Safety Door Folder:1,0,0,0,0 (with a checkmark). The main window is titled 'Library' and has tabs for 'Status', 'Properties', and 'Auto Clean'. The 'Status' tab is active, and within it, the 'General' sub-tab is selected. The 'State' section displays the following information:

Transition Request	-select-transition-
Health State	ok
Device State	Ready
Access State	online
Left Access Door	closed
Right Access Door	closed
Partition State	Valid

The 'Host Interface' section shows:

Host Interface Type	Non-Partitioned scsi
---------------------	----------------------

The bottom status bar shows 'SL3000', 'Comm Status', 'UserID: root', and a warning icon next to 'Library:crimson8.central.sun.com'.

## ▼ Display Library Status Alerts

---

**Note** – This feature is available only if the Service license is active on the library.

---



---

**Note** – If the Service license is not active on the library, then this screen will be blank except for a message indicating that the “Service license is not valid.”

---

Use this procedure to display library status alerts, which can help you to identify whether there are any current or pending issues with the library firmware or configuration. You might perform this procedure whenever the library health indicator has changed from green, to yellow or red, indicating a warning or error.

1. Select **Tools > System Detail**, and click the **Library** folder.
2. Click the **Status** tab, and then the **Status Module** tab.

The screen displays all library status alerts.

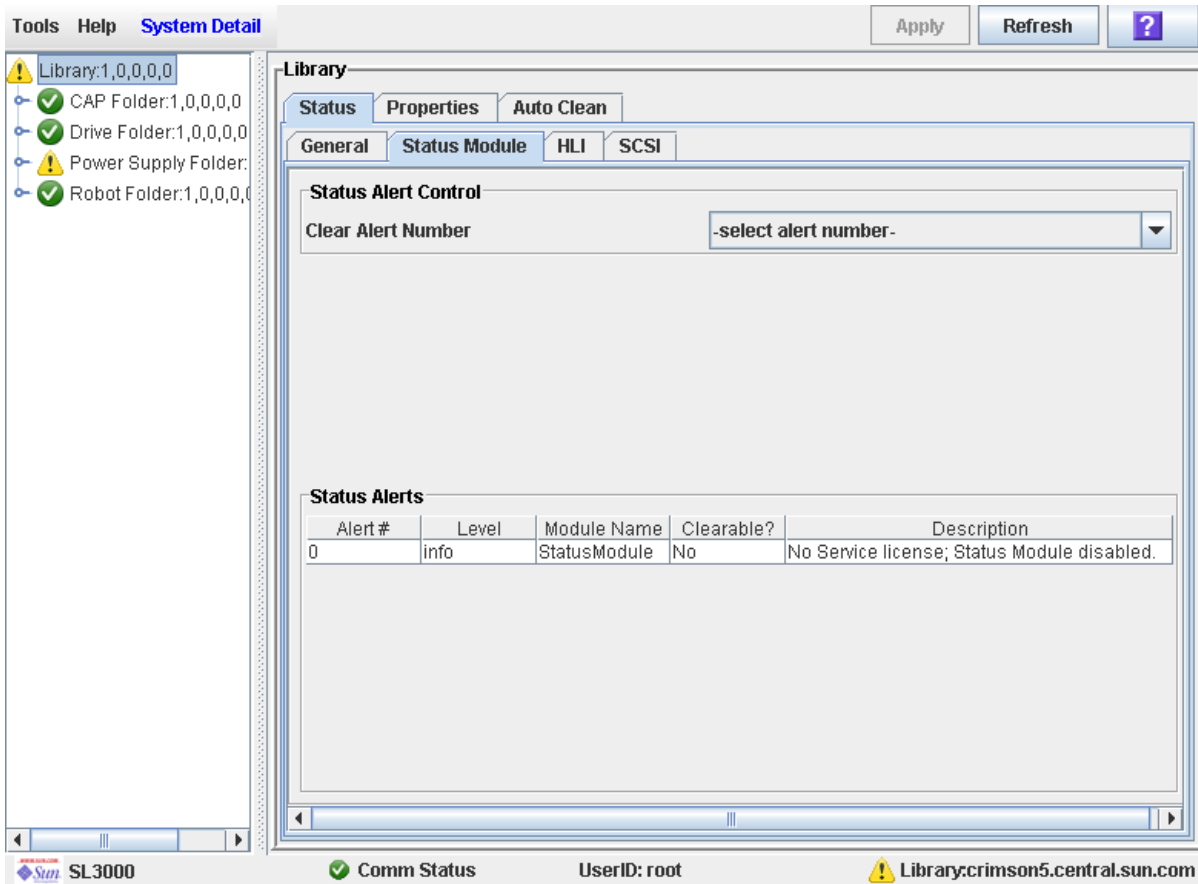

### Screen Fields

#### Clear Alert Number

Optional.

Status alert message you want to clear from the display.

The pull-down displays numbers 0–20. Although you can select any one of these, only the numbers that correspond to clearable alert messages shown in the display will actually cause a message to be cleared.

#### **Alert #**

Display only.

Sequential number assigned to the status alert message.

#### **Level**

Display only.

Severity level of the status alert message. Options are:

- OK – The firmware module is functioning normally.
- Information – Information message; the firmware module is functioning normally.
- Warning – The firmware module is operating in a degraded state; may indicate a future failure is possible.
- Error – The firmware module has experienced a failure.

#### **Module Name**

Display only.

Library controller firmware module that is affected by the message.

#### **Clearable?**

Display only.

Indicates whether the status alert message can be manually cleared from the display.

Options are:

- Yes – Message can be cleared, and the firmware module status will be returned to OK.
- No – Message cannot be cleared. Generally, OK and Information messages cannot be cleared.

#### **Description**

Display only.

Full description of the status alert message.

## **Buttons**

### **Apply**

Click to clear the selected alert message from the Status Module display. The firmware module status is returned to OK, and the library health indicator is updated.

---

**Note** – If the alert message is updated periodically, it will reappear with the next update cycle.

---

### **Refresh**

Click to refresh the display with current data from the library controller database.

## ▼ Clear Library Status Alerts

---

**Note** – This feature is available only if the Service license is active on the library.

---

Use this procedure to clear a library firmware status alert. Not all alerts can be cleared.

---

**Note** – Clearing an alert only removes it from this screen display. It does not resolve the underlying issue.

---

1. Select **Tools > System Detail**, and click the **Library** folder.
2. Click the **Status** tab, and then the **Status Module** tab.

The screen displays all library status alerts.

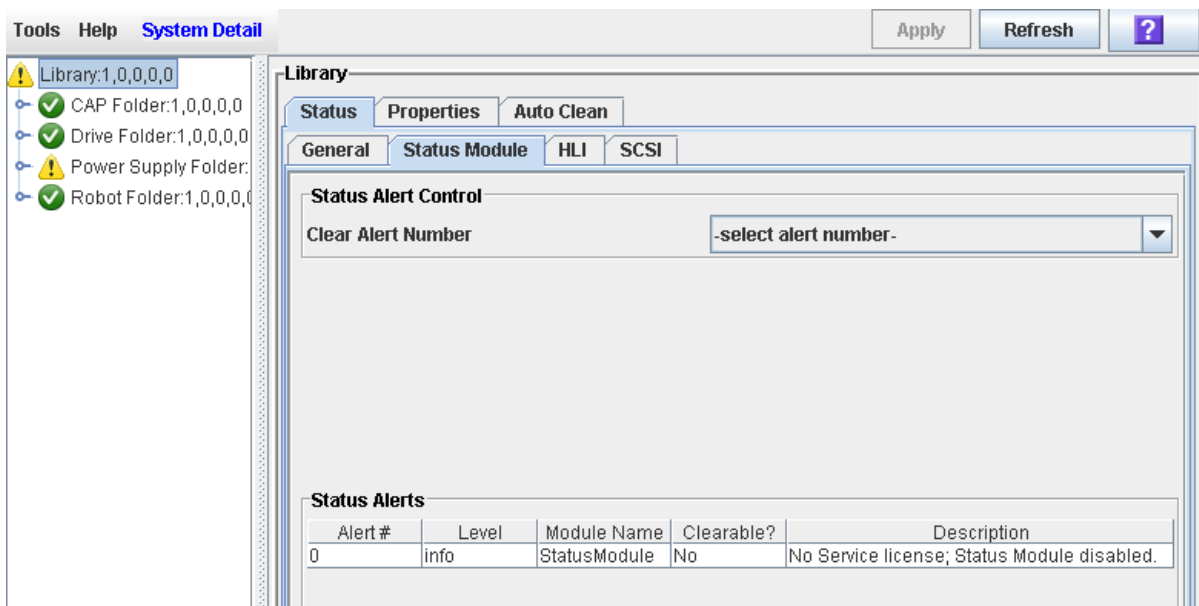

3. On the **Clear Alert Number** pull-down, select the alert number that you want to clear from the display, and Click **Apply**.

---

**Note** – Although you can select any alert number, only alerts marked as “Clearable” can actually be cleared.

---

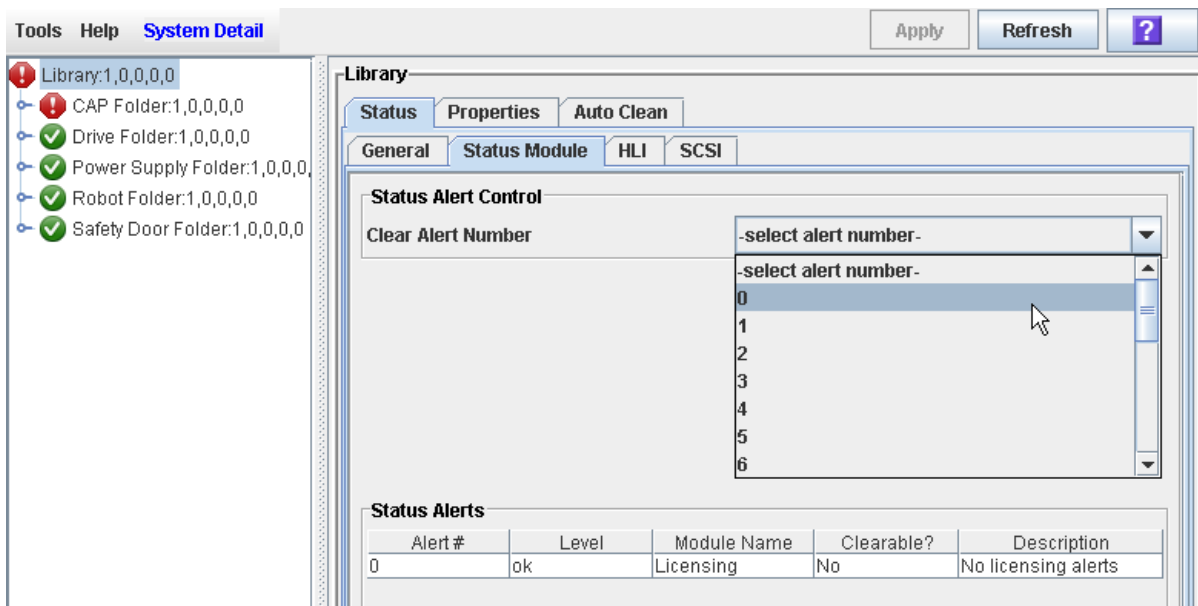

The alert is removed from the Status Module display. The library health indicator returns to green if there are no other device or status alerts.

---

**Note** – If the alert is subject to periodic updates, it will reappear at the next update cycle.

---

## ▼ Display HLI Port Status

Use this procedure to display the current status of all host LMU (library management unit) HLI interface ports on the library. Information includes the local TCP/IP socket, local IP, connection status, port status, transmission sent and received from the time of connection.

1. Select **Tools > System Detail**, and click the **Library** folder.
2. Click the **Status** tab, and then the **HLI** tab.

The screen displays the current status and activity of all HLI ports on the library.

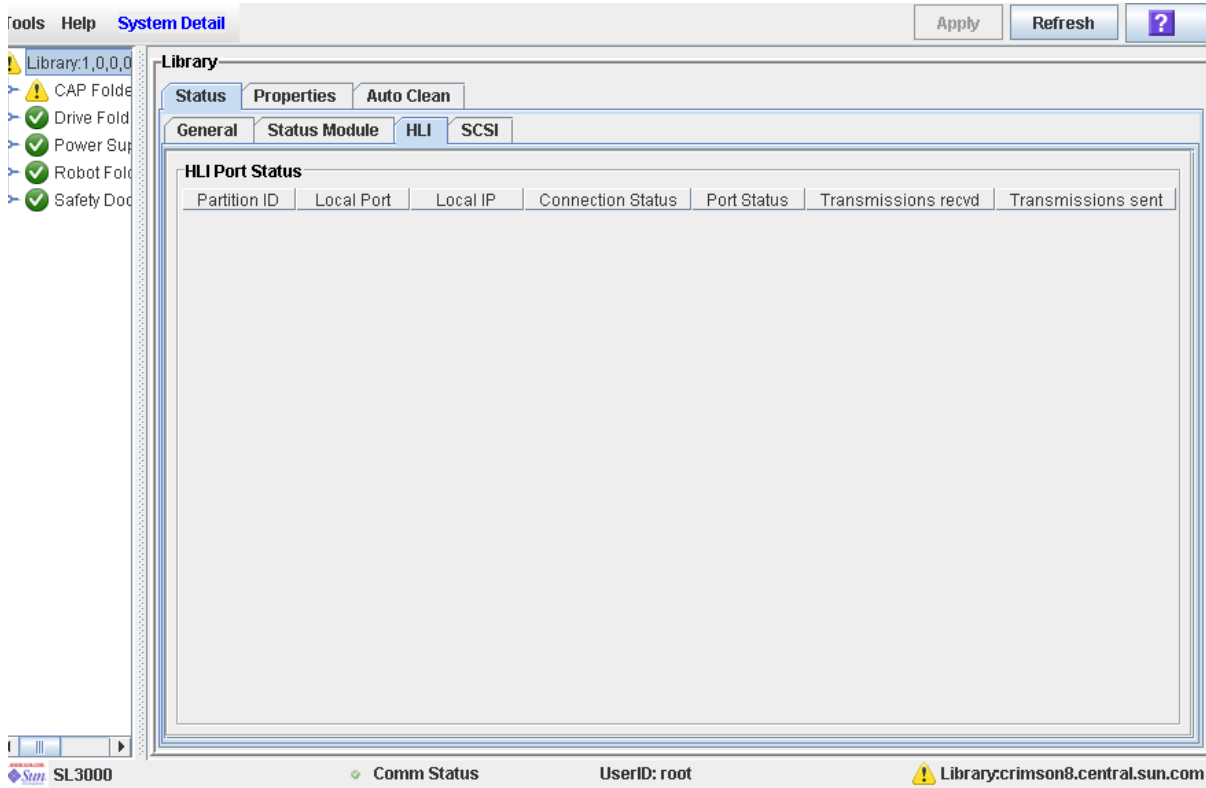

## ▼ Display FC-SCSI Port Status

Use this procedure to display the current status of all host FC-SCSI interface ports on the library. Information includes the port number, speed, and status, loop ID, World Wide Node Name, World Wide Port Name, and topology.

1. Select **Tools > System Detail**, and click the **Library** folder.
2. Click the **Status** tab, and then the **FC-SCSI** tab.

The screen displays the current status and activity of all FC-SCSI ports on the library.

The screenshot shows the SL3000 Automated Library Operations software interface. The main window is titled "Library" and has tabs for "Status", "Properties", and "Auto Clean". The "Status" tab is active, and within it, the "SCSI" sub-tab is selected. The "SCSI Port Status" table is displayed, showing the following data:

Port Number	Loop ID	Port Speed	Port Available	Port Enabled	FC WWN Node Name	FC WWN Port Name	Topology
2	128	2Gb	available	enabled	50:01:04:f0:00:aa:26:4e	50:01:04:f0:00:aa:26:4f	Fabric

The interface also shows a left-hand navigation pane with a tree view containing folders like "Library:1,0,0,0,0", "CAP Folder:1,0,0", "Drive Folder:1,0,0", "Power Supply Fo", and "Robot Folder:1,0". At the bottom of the window, there is a status bar with "SL3000", "Comm Status" (with a green checkmark), "UserID: root", and "Library:crimson19.central.sun.com" (with a green checkmark).

## ▼ Display Library Configuration Information

Use this procedure to display the physical, mechanical, and logical configuration of the library. Some of the information can be set up automatically during library initialization, while other information can be defined by the user.

---

**Note** – This information is also available through **Reports > Library Information**. See [“Display a Library Report” on page 114](#) for detailed instructions.

---

1. Select **Tools > System Detail**, and click the **Library** folder.
2. Click the **Properties** tab, and then the **General** tab.

The screen displays detailed information about the library.

The screenshot shows the 'System Detail' window for a library. The left sidebar lists folders: Library:1,0,0,0,0 (warning), CAP Folder:1,0,0,0,0 (check), Drive Folder:1,0,0,0,0 (check), Power Supply Folder:1,0,0,0,0 (warning), and Robot Folder:1,0,0,0,0 (check). The main area is titled 'Library' and has tabs for 'Status', 'Properties', and 'Auto Clean'. Under 'Properties', there are sub-tabs for 'General', 'Library Controller', and 'Drive Controller'. The 'General' tab is active, showing physical and host interface details.

Physical	
Vendor	STK
Frame Serial Number	57100000004
Expansion Module Count	2
Total Slot Count	1784
Empty Slot Count	1535
Drive Count	2
Robot Count	1
Cap Count	2
Drive Power Supply Count	5
Hardware Power Supply Count	5

Host Interface TCP/IP 2B	
DNS Domain Name	crimson5
IP Address	129.80.81.28
NetMask	255.255.254.0
MAC Address	00:10:4F:00:B9:88

Host Interface TCP/IP 2A	
IP Address	1.1.1.1
NetMask	255.255.255.255
MAC Address	00:10:4F:00:B9:89

At the bottom of the window, the status bar shows 'SL3000', 'Comm Status' (check), 'UserID: root', and 'Library:crimson5.stortek.com' (warning).



## ▼ Display Library Controller Properties

View details of the library controller, including the serial number and firmware versions.

**Note** – This information is also available through **Reports > Library Information**. See [“Display a Library Report”](#) on page 114 for detailed instructions.

1. Select **Tools > System Detail**, and click the **Library** folder.
2. Click the **Properties** tab, and then the **Library Controller** tab.

The screenshot shows the Sun SL3000 System Detail interface. The left sidebar lists several folders with green checkmarks: Library:1,0,0,0,0, CAP Folder:1,0,0,0,0, Drive Folder:1,0,0,0,0, Power Supply Folder:1,0,0,0,0, and Robot Folder:1,0,0,0,0. The main window is titled 'Library' and has tabs for 'Status', 'Properties', and 'Auto Clean'. The 'Properties' tab is active, and within it, the 'Library Controller' sub-tab is selected. The 'Library Controller' section displays the following information:

**Library Controller**

**Model** SL3000  
**FRU Serial Number** HBCR 74000293

**Code Version**

Name	Executing Version	Flash Version
build_version	FRS_2.31 (5.12.00)	FRS_2.31 (5.12.00)
controller.cramfs	5.11.12	5.11.12
disk.hbc.plmage	5.10.71	5.10.71
jre.cramfs	4.83.07	4.83.07
kernel.plmage	4.75.15	4.75.15
libs.cramfs	4.87.10	4.87.10
snmp.tarball	5.11.22	5.11.22
u-boot.bin	1.00.10	1.00.10

The bottom status bar shows 'SL3000', 'Comm Status' (green checkmark), 'UserID: root', and 'Library:crimson13.central.sun.com' (green checkmark).

## ▼ Display Drive Controller Properties

View details of the drive controller, including the serial number and current firmware versions.

**Note** – This information is also available through **Reports > Library Information**. See [“Display a Library Report”](#) on page 114 for detailed instructions.

1. Select **Tools > System Detail**, and click the **Library** folder.
2. Click the **Properties** tab, and then the **Drive Controller** tab.

The Drive Controller screen appears.

The screenshot shows the SL3000 interface with the 'System Detail' window open. The 'Library' folder is selected in the left sidebar. The 'Properties' tab is active, and the 'Drive Controller' sub-tab is selected. The 'Drive Controller Properties' section shows the FRU Serial Number as 'HBT 74000462'. Below this is a 'Code Version' table with the following data:

Name	Executing Version	Flash Version
disk.hbt.plmage	4.53.43	4.53.43
drive.cramfs	4.55.18	4.55.18
kernel.plmage	4.48.72	4.48.72
libs.cramfs	4.49.10	4.49.10
u-boot.bin	1.00.06	1.00.06

The bottom status bar shows 'SL3000', 'Comm Status' (green checkmark), 'UserID: root', and 'Library:crimson5.storitek.com' (yellow warning icon).

## ▼ Change the Library Interface Type (Non-Partitioned Libraries)

Use this procedure to change the interface type that all hosts use to connect to the library.

---

**Note** – This procedure applies to non-partitioned libraries only. To change interface types in a partitioned library, see [“Modify the Interface Type of a Host-Partition Connection” on page 307](#). [“Modify the Interface Type of a Host-Partition Connection” on page 307](#)

---

### 1. Select Tools > Select Active Cells.

The **Module Map** screen appears.

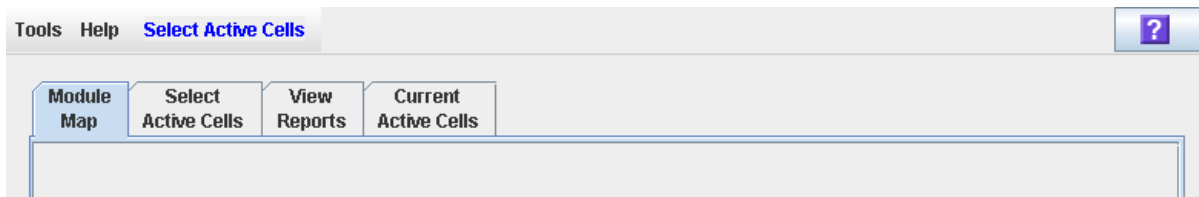

2. Click the Select Active Cells tab.

The **Select Active Cells** screen appears, displaying the interface type currently assigned to the library.

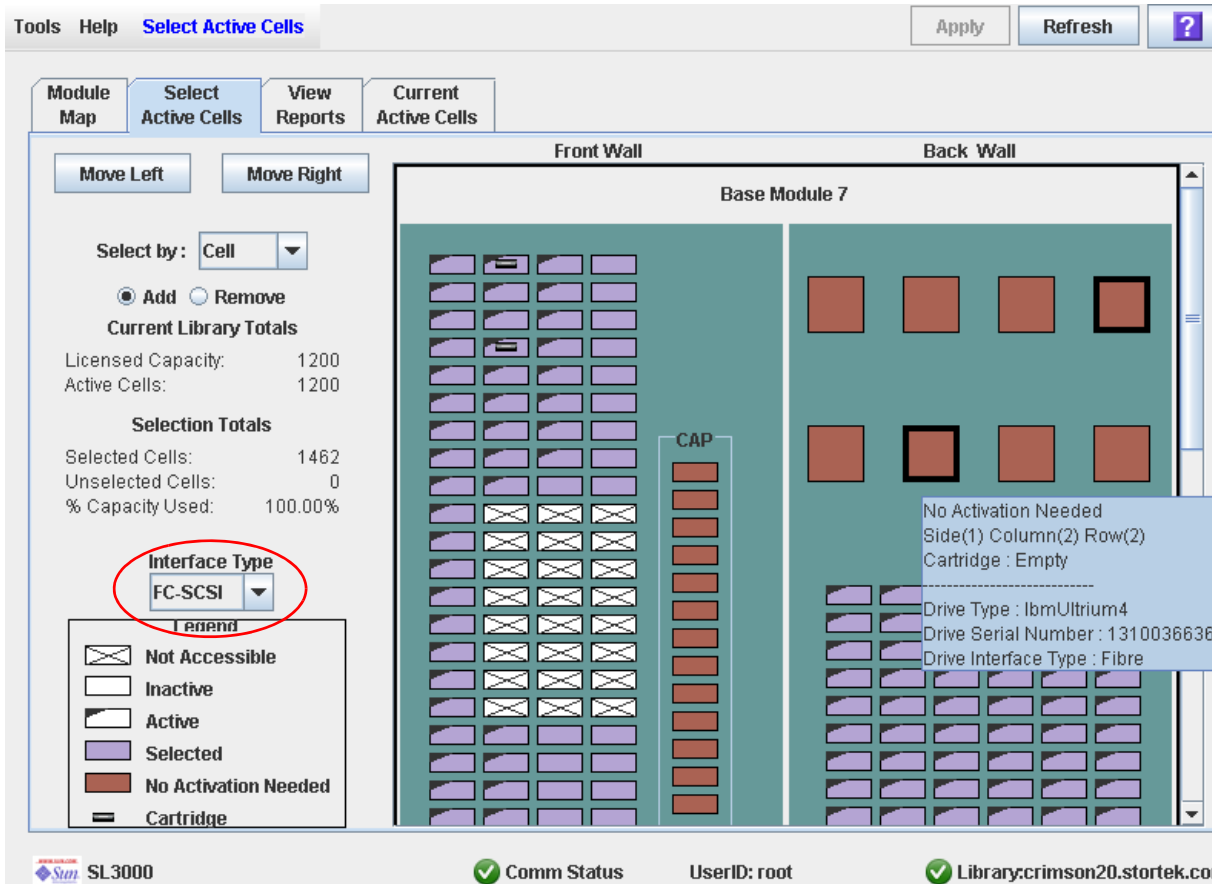

3. In the Interface Type pull-down, select the interface type you want to assign. Click Apply.

The **Confirm Apply** popup appears.



4. Click Yes to update the library controller database.

The **Commit Success** popup appears.

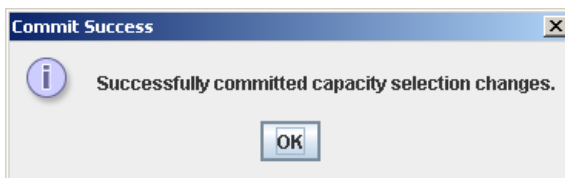

**5. Click OK to return to the Select Active Cells screen.**

The new interface type is active immediately; the library does not need to be rebooted.

## ▼ Display a Library Report

Use this procedure to display library reports available from the **Tools > Reports** menu.

---

**Note** – All report output is a static display of information sent from the library controller at the time the report is generated. The SL Console does not update the information dynamically unless you explicitly select the **Update** button on the Options Bar.

---

If you want to search the report data or save it to a file, see the following procedures:

- [“Search a Library Report” on page 116](#)
- [“Save Library Report Data to a File” on page 118](#)

Additional reports are available from the following menus:

- **Tools > Partitions**
- **Tools > Select Active Cells**

### 1. Select **Tools > Reports**.

The reports **Display** screen appears. All library report options are listed in the navigation bar.

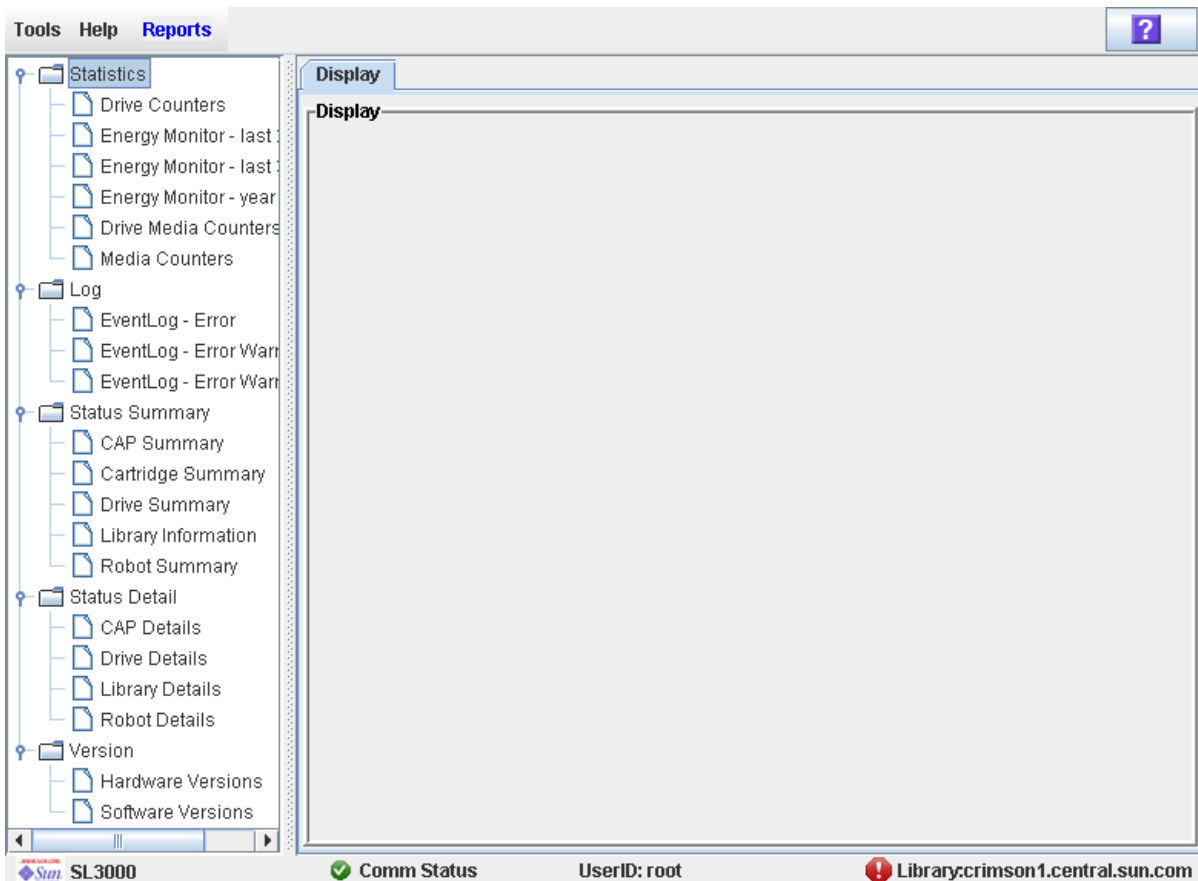

### 2. In the navigation bar, expand a report category to see the report options.

### 3. Click the report you want to display.

The selected report is displayed.

The screenshot shows the SL3000 software interface. The 'Reports' tab is active, and the 'EventLog - Error' report is selected in the left-hand tree view. The main display area shows the following information:

EventLog - Error  
Generated on : Thu Feb 28 13:13:30 MST 2008

Event

Time : 2007-12-21T08:22:24.528  
Device Address : 1.1.0.2.0  
User : root  
Requester : default  
Activity : internal  
Request Id : 0  
Level : error  
Result Code : 3333  
Text : "Dropped unexpected device response"  
Parameters : Data=<response sequence="57"

final="false"><command>audit</command><result  
identifier="1"><resultStatus><resultSeverity>info</resultSeverity><resultCode>0000</resultCode><res  
ultText><![CDATA|End of  
Text||></resultText><operationalState>000</operationalState></resultStatus><cartPresent>false</cartP  
resent><upsideDown>false</upsideDown><address>1,1,7,1,45</address><label><![CDATA|></labe  
l></result></response>

Time : 2007-12-21T08:22:24.575  
Device Address : 1.1.0.2.0  
User : root  
Requester : default

The status bar at the bottom indicates: **SL3000**, **Comm Status** (green checkmark), **UserID: root**, and **Library:crimson20.stortek.com** (green checkmark).

## ▼ Search a Library Report

Use this procedure to search a library report for a specified text string. This procedure can be performed on any of the library report screens.

**1. Select Tools > Reports.**

The reports **Display** screen appears. All library report options are listed in the navigation bar.

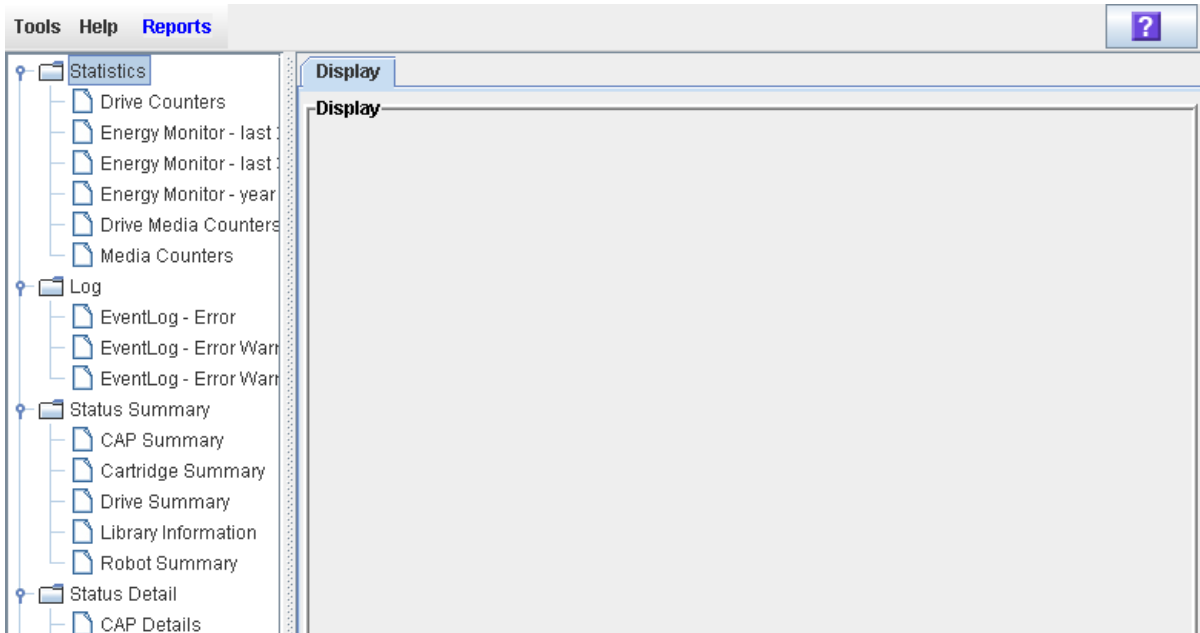

**2. In the navigation bar, expand a report category to see the report options.**

**3. Click the report you want to display.**

The specified report is displayed. All report screens include the **Search** button on the Options Bar.

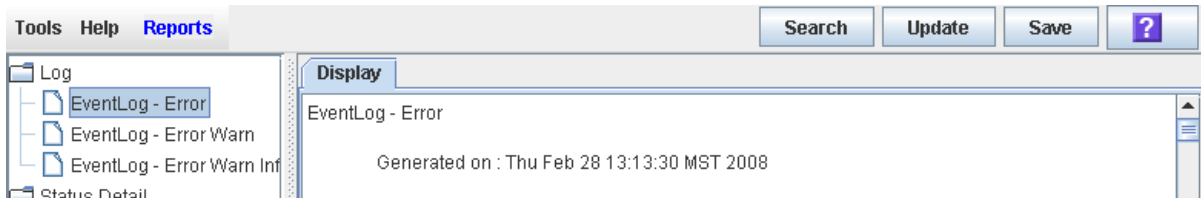

**4. Click Search.**

The **Search Text** popup appears.

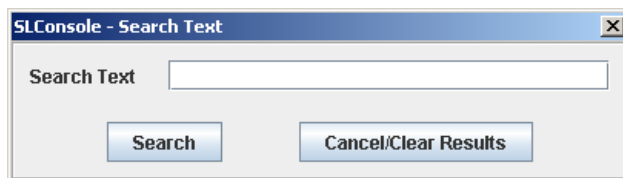

**5. Enter the text string you want to search for, and click Search.**



---

**Note** – The search is case-sensitive, and wildcards are not supported.

---

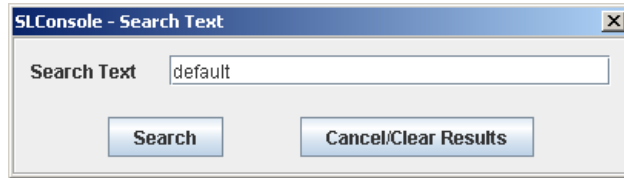

6. The Search Results popup appears, displaying the number of occurrences of the text string. All instances of the text string in the report are highlighted.

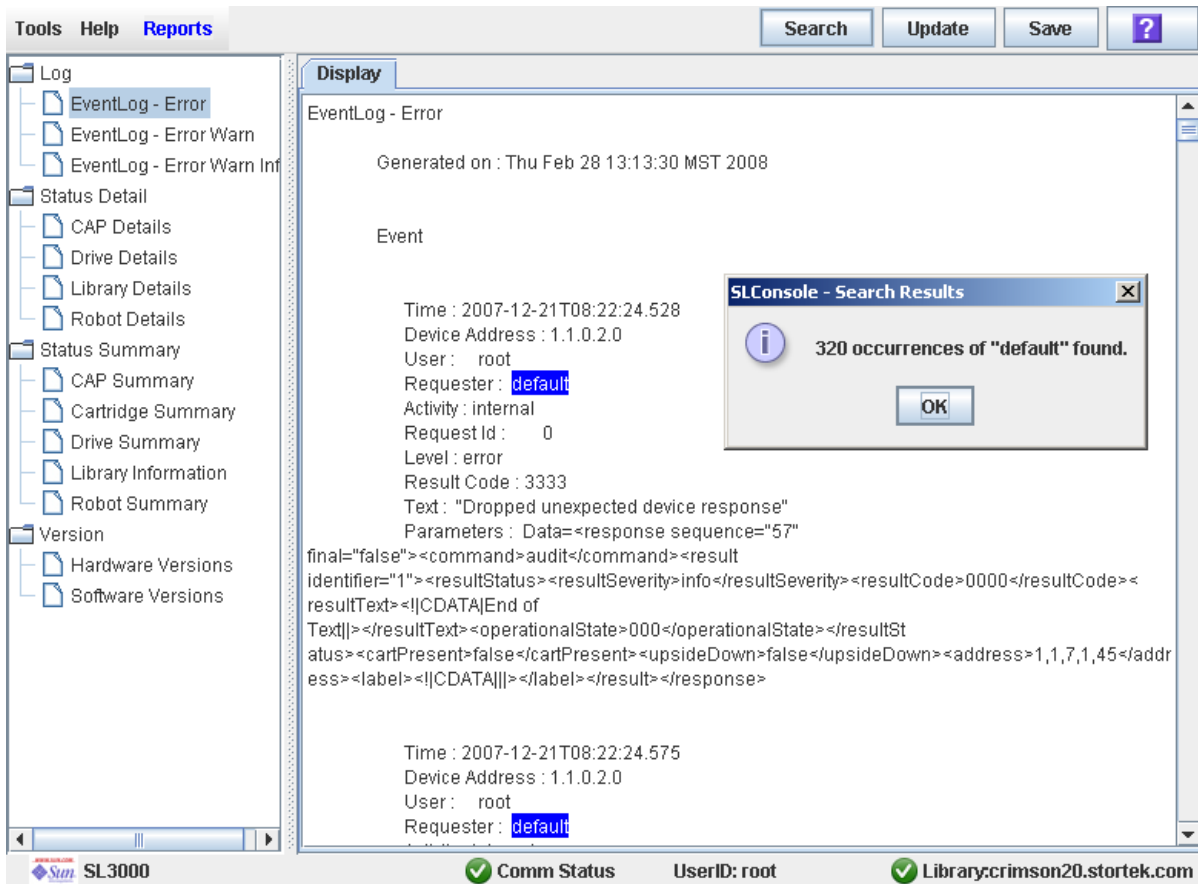

7. Click OK to dismiss the popup.

## ▼ Save Library Report Data to a File

Use this procedure to display a library report and save the data to a file. Depending on the report, you can save to in text (.txt), HTML, XML, or comma-separated values (.csv) format. This procedure can be performed from any of the library report screens.

Once the file is saved, you can print it or include it in e-mail. This may be useful for communicating about library issues with your Sun support representative. Also, you can import a .csv file into a spreadsheet or charting application in order to better understand and interpret the data.

### 1. Select Tools > Reports.

The reports **Display** screen appears. All library report options are listed in the navigation bar.

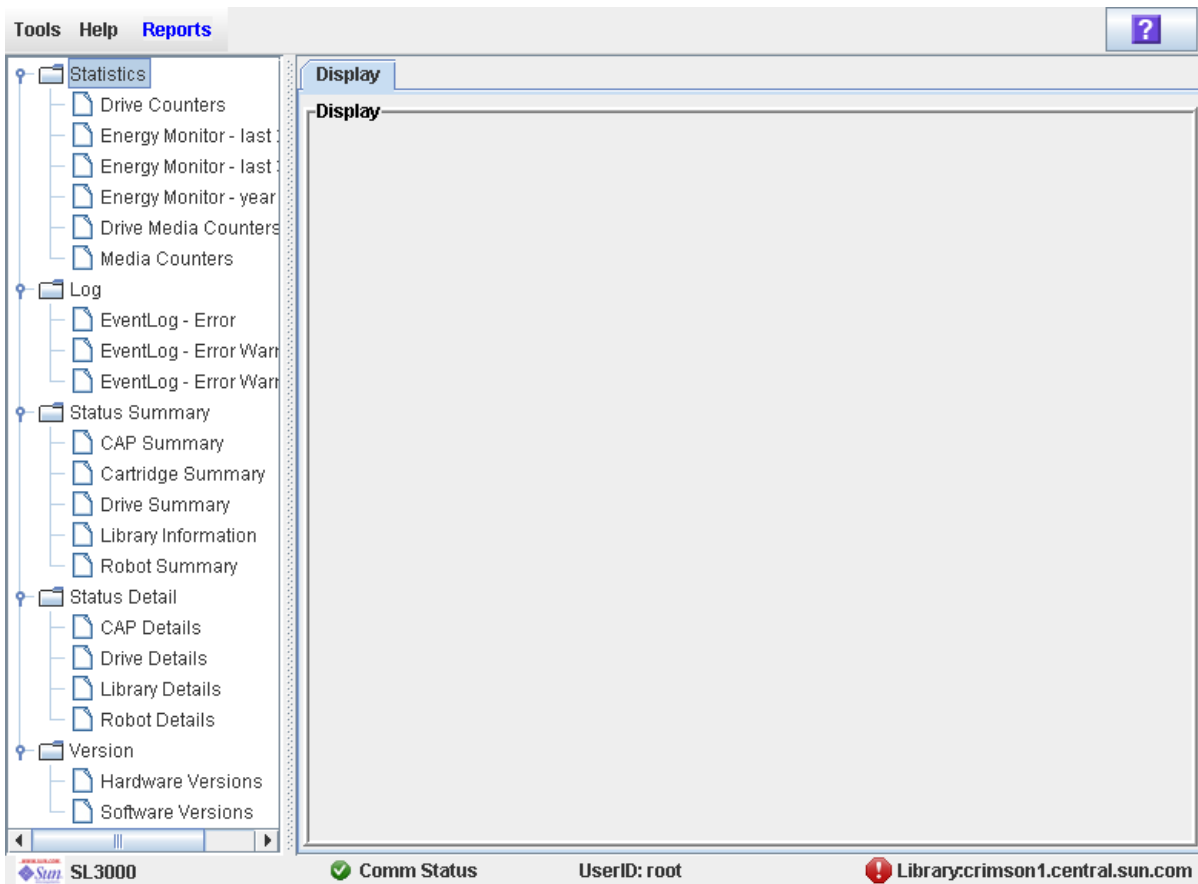

### 2. In the navigation bar, expand a report category to see the report options.

3. Click the report you want to display.

The specified report is displayed. All report screens include the **Save** button on the Options Bar.

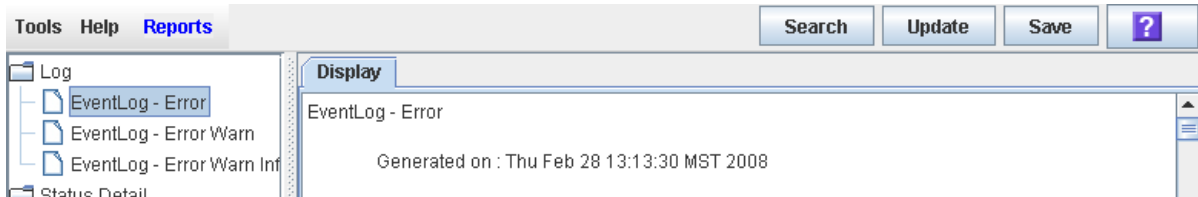

4. Click Save.

The **Save** popup appears.

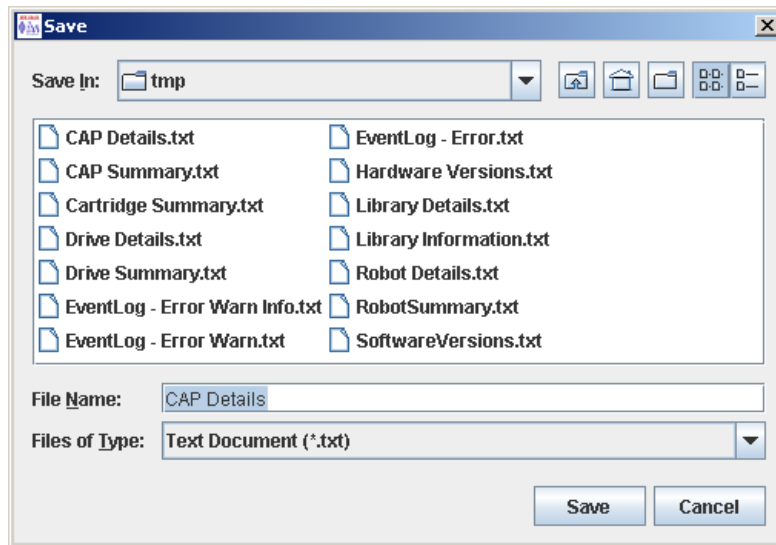

5. Browse to the directory where you want to save the file. In the File Name field, you can accept the default entry or enter a different file name.

6. In the Files of Type pull-down, select the format in which you want to save the data (HTML, Text, XML, .csv).

7. Click Save.

The data is saved to the specified file.

---

**Note** – If the file exists already, a popup appears prompting you whether you want to replace the file.

---

## ▼ Display the “Last 24 Hours” Library Energy Monitor Report

**Note** – This feature is available starting with SL3000 firmware version FRS\_2.30 and SL Console version FRS\_4.30.

The Last 24 Hours Energy Monitor Report displays minute-by-minute energy and average power usage for the entire library over the last 24 hours. This report helps you to monitor your power and energy usage and identify periods of peak and low usage during the day.

By default, the report is sorted in chronological order. Optionally, you can change the sort order, and rearrange and resize the columns. See [“Modifying the Screen Layout” on page 36](#).

To create a chart from this report, you can save the data to a comma-separated (.csv) file and then import the .csv file into a charting application. For details, see [“Save Library Report Data to a File”](#).

For related reports, see the following:

- [“Display the “Last Month” Library Energy Monitor Report” on page 122](#)
- [“Display the “Last Year” Library Energy Monitor Report” on page 124](#)

1. Select **Tools > Reports**.
2. Expand the **Statistics** folder, and click **Energy Monitor - Last 24 Hours**.

date	kWh	kW
Wed Mar 18 07:17:11 MDT 20...	0.005199	0.31194
Wed Mar 18 07:18:11 MDT 20...	0.005121	0.30726
Thu Mar 19 02:46:45 MDT 20...	0.005121	0.30726
Thu Mar 19 02:47:45 MDT 20...	0.005199	0.31194
Thu Mar 19 02:48:45 MDT 20...	0.005121	0.30726
Thu Mar 19 02:49:45 MDT 20...	0.005121	0.30726
Thu Mar 19 02:50:45 MDT 20...	0.005199	0.31194
Thu Mar 19 02:51:45 MDT 20...	0.005121	0.30726
Thu Mar 19 02:52:45 MDT 20...	0.005043	0.30258
Thu Mar 19 02:53:45 MDT 20...	0.005199	0.31194
Thu Mar 19 02:54:45 MDT 20...	0.005121	0.30726
Thu Mar 19 02:55:45 MDT 20...	0.005121	0.30726
Thu Mar 19 02:56:45 MDT 20...	0.005043	0.30258
Thu Mar 19 02:57:45 MDT 20...	0.005199	0.31194
Thu Mar 19 02:58:45 MDT 20...	0.005121	0.30726
Thu Mar 19 02:59:45 MDT 20...	0.005121	0.30726
Thu Mar 19 03:00:45 MDT 20...	0.005199	0.31194
Thu Mar 19 03:01:45 MDT 20...	0.005043	0.30258
Thu Mar 19 03:02:45 MDT 20...	0.005121	0.30726
Thu Mar 19 03:03:45 MDT 20...	0.005199	0.31194
Thu Mar 19 03:04:45 MDT 20...	0.005121	0.30726
Thu Mar 19 03:05:45 MDT 20...	0.005121	0.30726
Thu Mar 19 03:06:45 MDT 20...	0.005121	0.30726
Thu Mar 19 03:07:45 MDT 20...	0.005121	0.30726
Thu Mar 19 03:08:45 MDT 20...	0.005121	0.30726
Thu Mar 19 03:09:45 MDT 20...	0.005199	0.31194
Thu Mar 19 03:10:45 MDT 20...	0.005043	0.30258
Thu Mar 19 03:11:45 MDT 20...	0.005121	0.30726
Thu Mar 19 03:12:45 MDT 20...	0.005199	0.31194

## Screen Fields

### **Date**

Date and time of the measurements.

### **kWh**

Energy used by the entire library during the identified one-minute interval, measured in kilowatt-hours.

### **kW**

Average power used by the entire library during the identified one-minute interval, measured in kilowatts.

## ▼ Display the “Last Month” Library Energy Monitor Report

**Note** – This feature is available starting with SL3000 firmware version FRS\_2.30 and SL Console version FRS\_4.30.

The Last Month Energy Monitor Report displays energy and average power usage for the entire library, measured in 15-minute intervals over the last 32 days. This report helps you to analyze your power and energy usage and identify periods of peak and low usage during the last month.

By default, the report is sorted in chronological order. Optionally, you can change the sort order, and rearrange and resize the columns. See [“Modifying the Screen Layout” on page 36](#).

To create a chart from this report, you can save the data to a comma-separated (.csv) file and then import the .csv file into a charting application. For details, see [“Save Library Report Data to a File”](#).

For related reports, see the following:

- [“Display the “Last 24 Hours” Library Energy Monitor Report” on page 120](#)
- [“Display the “Last Year” Library Energy Monitor Report” on page 124](#)

1. Select **Tools > Reports**.
2. Expand the **Statistics** folder, and click **Energy Monitor - Last Month**.

date	kWh	kW
Wed Feb 04 03:15:00 MST 2...	0.3947082497179508	1.5788329988718033
Wed Feb 04 03:30:00 MST 2...	0.36883271203190088	1.4733084812760353
Wed Feb 04 03:45:00 MST 2...	0.3423339445143938	1.3693357780575752
Wed Feb 04 04:00:00 MST 2...	0.3948634266853333	1.5794537067413332
Wed Feb 04 04:15:00 MST 2...	0.3948634285479784	1.5794537141919136
Wed Feb 04 04:30:00 MST 2...	0.3947858382016421	1.5791433528065684
Wed Feb 04 04:45:00 MST 2...	0.3948634266853333	1.5794537067413332
Wed Feb 04 05:00:00 MST 2...	0.3947858363389969	1.5791433453559875
Wed Feb 04 05:15:00 MST 2...	0.3949410207569599	1.5797640830278397
Wed Feb 04 05:30:00 MST 2...	0.3947858382016421	1.5791433528065684
Wed Feb 04 05:45:00 MST 2...	0.3947858400642872	1.5791433602571487
Wed Feb 04 06:00:00 MST 2...	0.3962600752711296	1.5850403010845184
Wed Feb 04 06:15:00 MST 2...	0.3933891896158457	1.5735567584633827
Wed Feb 04 06:30:00 MST 2...	0.3947858363389969	1.5791433453559875
Wed Feb 04 06:45:00 MST 2...	0.3948634322732687	1.5794537290930748
Wed Feb 04 07:00:00 MST 2...	0.3947858382016421	1.5791433528065684
Wed Feb 04 07:15:00 MST 2...	0.39478584192693233	1.5791433677077293
Wed Feb 04 07:30:00 MST 2...	0.394630653783679	1.578522615134716
Wed Feb 04 07:45:00 MST 2...	0.3945530615746975	1.57821224629879
Wed Feb 04 08:00:00 MST 2...	0.3945530615746975	1.57821224629879
Wed Feb 04 08:15:00 MST 2...	0.3945530634373425	1.57821225374937
Wed Feb 04 08:30:00 MST 2...	0.3947082497179508	1.5788329988718033
Wed Feb 04 08:45:00 MST 2...	0.3945530652999878	1.5782122611999512
Wed Feb 04 09:00:00 MST 2...	0.3945530597120524	1.5782122388482096
Wed Feb 04 09:15:00 MST 2...	0.39455306716263294	1.5782122686505318
Wed Feb 04 09:30:00 MST 2...	0.39463065564632416	1.5785226225852966
Wed Feb 04 09:45:00 MST 2...	0.3944754768162966	1.5779019072651863
Wed Feb 04 10:00:00 MST 2...	0.3945530634373425	1.57821225374937
Wed Feb 04 10:15:00 MST 2...	0.3944754730010063	1.5779018923610251

## Screen Fields

### **Date**

Date and time of the measurements.

### **kWh**

Energy used by the entire library during the identified 15-minute interval, measured in kilowatt-hours.

### **kW**

Average power used by the entire library during the identified 15-minute interval, measured in kilowatts.

## ▼ Display the “Last Year” Library Energy Monitor Report

**Note** – This feature is available starting with SL3000 firmware version FRS\_2.30 and SL Console version FRS\_4.30.

The Last Year Energy Monitor Report displays energy and average power usage for the entire library, measured in one-day intervals over the last 365 days. This report helps you to analyze your power and energy usage and identify periods of peak and low usage during the year.

By default, the report is sorted in chronological order. Optionally, you can change the sort order, and rearrange and resize the columns. See [“Modifying the Screen Layout” on page 36](#).

To create a chart from this report, you can save the data to a comma-separated (.csv) file and then import the .csv file into a charting application. For details, see [“Save Library Report Data to a File”](#).

For related reports, see the following:

- [“Display the “Last 24 Hours” Library Energy Monitor Report” on page 120](#)
- [“Display the “Last Month” Library Energy Monitor Report” on page 122](#)

1. Select **Tools > Reports**.
2. Expand the **Statistics** folder, and click **Energy Monitor - Last Year**.

date	Total ...	Avg kW	Max k...	Min k...	Avg k...	Max k...	Min kW	Avg kW
Mon Ja...	9.59241...	0.42132...	0.28010...	0.39968...	0.399684	1.68528...	1.12042...	1.59873...
Tue Jan...	37.4590...	0.39199...	0.38780...	0.39019...	1.560793	1.56797...	1.55121...	1.56079...
Wed Ja...	37.3773...	0.39618...	0.28142...	0.38934...	1.557389	1.58472...	1.12569...	1.55738...
Thu Jan...	30.6320...	0.40580...	0.11010...	0.39271...	1.276336	1.62321...	0.44040...	1.57087...
Fri Jan ...	38.5581...	0.40626...	0.29539...	0.40164...	1.606588	1.62507...	1.18156...	1.60658...
Sat Jan ...	38.8808...	0.40673...	0.40324...	0.40500...	1.620037	1.62693...	1.61297...	1.62003...
Sun Jan...	38.8788...	0.40657...	0.40324...	0.40498...	1.61995	1.62631...	1.61297...	1.61995...
Mon Ja...	38.8507...	0.40642...	0.37794...	0.40469...	1.618783	1.62569...	1.51179...	1.61878...
Tue Jan...	23.8950...	0.40650...	0.13330...	0.39825...	0.995629	1.62600...	0.53320...	1.59300...
Wed Ja...	38.8105...	0.40665...	0.32425...	0.40427...	1.617108	1.62662...	1.29702...	1.61710...
Thu Jan...	38.8672...	0.40704...	0.37903...	0.40486...	1.619468	1.62818...	1.51613...	1.61946...
Fri Jan ...	38.8813...	0.40665...	0.40332...	0.40501...	1.620057	1.62662...	1.61328...	1.62005...
Sat Jan ...	38.8746...	0.40673...	0.40332...	0.40494...	1.619775	1.62693...	1.61328...	1.61977...
Sun Jan...	38.8472...	0.40657...	0.37779...	0.40465...	1.618637	1.62631...	1.51117...	1.61863...
Mon Ja...	38.8693...	0.40657...	0.40339...	0.40488...	1.619556	1.62631...	1.61359...	1.61955...
Tue Jan...	32.8508...	0.40650...	0.05485...	0.40062...	1.368786	1.62600...	0.21942...	1.60248...
Wed Ja...	17.6045...	0.40626...	0.18955...	0.40010...	0.733521	1.62507...	0.75822...	1.60041...
Thu Jan...	38.9586...	0.41069...	0.37794...	0.40581...	1.623277	1.64276...	1.51179...	1.62327...
Fri Jan ...	39.1723...	0.41177...	0.40394...	0.40804...	1.63218	1.64711...	1.61576...	1.63218...
Sat Jan ...	38.9317...	0.40735...	0.40401...	0.40553...	1.622158	1.62942...	1.61607...	1.62215...
Sun Fe...	38.7684...	0.40595...	0.40060...	0.40383...	1.615353	1.62383...	1.60242...	1.61535...
Mon Fe...	38.6471...	0.40518...	0.37306...	0.40257...	1.61103	1.62073...	1.49224...	1.61029...
Tue Feb...	37.8255...	0.39835...	0.34233...	0.39401...	1.576066	1.59342...	1.36933...	1.57606...
Wed Fe...	37.5432...	0.39618...	0.28933...	0.39107...	1.564301	1.58472...	1.15735...	1.56430...
Thu Feb...	31.4626...	0.39563...	0.31548...	0.39328...	1.310942	1.58255...	1.26194...	1.57313...
Fri Feb ...	18.4864...	0.39579...	0.34217...	0.39332...	0.770268	1.58317...	1.36871...	1.57331...
Sat Feb ...	19.3462...	0.39571...	0.02630...	0.38692...	0.806095	1.58286...	0.10521...	1.54770...
Sun Fe...	21.3349...	0.42411...	0.08387...	0.410288	0.888957	1.69646...	0.33550...	1.641152
Mon Fe...	40.4488...	0.424658	0.338066	0.421343	1.685371	1.698632	1.352264	1.685372



## Screen Fields

### **Date**

Date of the measurements.

### **Total kWh**

Total energy used by the entire library during the day, measured in kilowatt-hours.

### **Avg kW**

Average power used by the entire library during the day, measured in kilowatts.

### **Max kWh**

Maximum 15-minute-period energy value for the day.

### **Min kWh**

Minimum 15-minute-period energy value for the day.

### **Avg kWh**

Average of all 15-minute-period energy values for the day.

### **Max kW**

Maximum 15-minute-period power value for the day.

### **Min kW**

Minimum 15-minute-period power value for the day.

### **Avg kW**

Average of all 15-minute-period power values for the day.

---

# Rotational and AEM CAP Management Tasks

<b>Task</b>	<b>Page</b>
<a href="#">Display Rotational and AEM CAP Summary Information</a>	127
<a href="#">Display Current Rotational or AEM CAP Status</a>	128
<a href="#">Display Rotational or AEM CAP Properties</a>	131
<a href="#">Unlock a CAP or AEM Access Door</a>	134
<a href="#">Lock a CAP or AEM Access Door</a>	136
<a href="#">Change the CAP Assignment Mode for an FC-SCSI Library</a>	138

## ▼ Display Rotational and AEM CAP Summary Information

Use this procedure to display summary information for all rotational and AEM CAPs in the library.

**Note** – This information is also available through **Reports > CAP Summary**. See [“Display a Library Report” on page 114](#) for detailed instructions.

1. Select **Tools > System Detail**, and click the **CAP folder**.

The screen lists all the library rotational and AEM CAPs and their locations.

The screenshot shows the 'System Detail' window with the 'CAP Folder' selected. The left sidebar lists various folders, including 'Library:1,0,0,0,0', 'CAP Folder:1,0,0,0,0', and several 'Drive Folder', 'Power Supply Folder', 'Robot Folder', and 'Safety Door Folder' entries. The main area displays a table titled 'Cap Data' with the following columns: Internal Addr, Access State, Reserved, and Reserver.

Internal Addr	Access State	Reserved	Reserver
1,1,-31,2,0	online	true	scsi0
1,1,-8,2,0	online	true	scsi0
1,1,11,2,0	online	true	scsi0
1,1,17,2,0	online	true	scsi0
1,1,23,2,0	online	true	scsi0
1,1,31,2,0	online	true	scsi0
1,1,5,2,0	online	true	scsi0

At the bottom of the window, the status bar shows 'Comm Status' (checked), 'UserID: root', and 'Library:crimson6.central.sun.com' (checked).

## ▼ Display Current Rotational or AEM CAP Status

Use this procedure to display the current operational state of a rotational or AEM CAP.

---

**Note** – This information is also available on the **CAP Details** report. See [“Display a Library Report” on page 114](#) for detailed instructions.

---

---

**Note** – Status information on the AEM safety door, which is the internal “garage” door that lowers to separate the AEM from the rest of the library, is displayed on the **Safety Door Status** screen. See [“Display AEM Safety Door Status” on page 199](#) for detailed instructions.

---

---

**Note** – This screen is used for both rotational and AEM CAPs. Throughout this section, the term “CAP” refers to both types of CAPs.

---

1. **Select Tools > System Detail.**
2. **Expand the CAP Folder, and click the CAP you want to display.**

---

**Note** – AEM CAPs are identified as follows: column “-31” for a left AEM CAP, and column “31” for a right AEM CAP.

---

3. **Click Status.**

The screen displays the current status of the selected CAP.

- For rotational CAPs:

The screenshot shows the Sun SL3000 System Detail window. The left pane displays a tree view of the system hierarchy, with the following items expanded:

- Library:1,0,0,0,0
  - CAP Folder:1,0,0,0,0
    - CAP:1,1,-31,2,0
    - CAP:1,1,-8,2,0
    - CAP:1,1,11,2,0 (selected)
    - CAP:1,1,17,2,0
    - CAP:1,1,23,2,0
    - CAP:1,1,31,2,0
    - CAP:1,1,5,2,0
  - Drive Folder:1,0,0,0,0
  - Power Supply Folder:1,0,0,0,0
  - Robot Folder:1,0,0,0,0
  - Safety Door Folder:1,0,0,0,0

The right pane shows the 'CAP' properties for the selected item. It has two tabs: 'Status' and 'Properties'. The 'Status' tab is active, displaying the following information:

**CAP Status**

Transition Request: -select-transition-

Health State: ok

Device State: Ready

Access State: online

Locked: false

Mode: idle

CAP Door: closed

Reserved: true

Reserver: scsi0

Association: scsi0

**CAP Cartridges**

Cartridge	Location
EN19350R	1,1,11,2,7
EN28670R	1,1,11,2,16
EN39540R	1,1,11,2,26

The bottom status bar shows: Sun SL3000, Comm Status (checked), UserID: root, and Library:crimson6.central.sun.com (checked).

■ For AEM CAPs:

The screenshot shows the Sun SL3000 interface with the 'System Detail' window open for a CAP. The left sidebar shows a tree view of the system hierarchy, with 'CAP:1,1,31,2,0' selected. The main window displays the 'CAP Status' properties and a table of 'CAP Cartridges'.

**Tools Help System Detail** [Apply] [Refresh] [?]

**-CAP-**

**Status Properties**

**CAP Status**

Transition Request: -select-transition-

Health State: ok

Device State: Ready

Access State: online

Locked: false

Mode: idle

CAP Door: closed

Reserved: true

Reserver: scsi0

Association: scsi0

**CAP Cartridges**

Cartridge	Location
0005740R	1,1,31,1,31
M002910R	1,1,31,2,39
0010800R	1,1,32,2,21
M054900R	1,1,33,1,32
0010050R	1,1,33,2,15
0005170R	1,1,33,2,19
M009640R	1,1,33,2,39

SL3000 [Sun] Comm Status UserID: root Library:crimson6.central.sun.com

## ▼ Display Rotational or AEM CAP Properties

Use this procedure to display static information for a rotational or AEM CAP, including the serial number and number of cells.

---

**Note** – This information is also available through **Reports > CAP Details**. See [“Display a Library Report” on page 114](#) for detailed instructions.

---

---

**Note** – For AEM CAPs, this information is also displayed on the **Safety Door Properties** screen. See [“Display AEM Safety Door Properties” on page 200](#) for detailed instructions.

---

---

**Note** – This screen is used for both rotational and AEM CAPs. Throughout this section, the term **“CAP”** refers to both types of CAPs.

---

1. **Select Tools > System Detail.**
2. **Expand the CAP Folder, and click the CAP you want to display.**

---

**Note** – AEM CAPs are identified as follows: column **“-31”** for a left AEM CAP, and column **“31”** for a right AEM CAP.

---

3. **Click Properties.**

The **CAP Properties** screen appears.

- For rotational CAPs:

The screenshot shows the SL3000 management interface. On the left is a tree view of the system components, including Library, CAP Folder, several CAPs, Drive Folder, Power Supply Folder, and Robot Folder. The 'CAP:1,1,-14,2,0' is selected. The main window displays the 'CAP Properties' for this selected CAP. The 'FRU Serial Number' is 'HBC 74001311' and the 'Size' is '26'. Below this is a 'Code Version' table with one row showing 'N/A' for Name, 'none' for Executing Version, and 'none' for Flash Version. The status bar at the bottom shows 'Comm Status' as green, 'UserID: root', and a warning icon for 'Library:colibtst11.stortek.com'.

CAP Properties		
FRU Serial Number	HBC 74001311	
Size	26	

Code Version		
Name	Executing Version	Flash Version
N/A	none	none



- For AEM CAPs:

The screenshot displays the Sun SL3000 management interface. On the left, a tree view shows the system hierarchy with 'CAP:1,1,-31,2,0' selected. The main window shows the 'CAP Properties' tab, which includes the FRU Serial Number (PUX 96000063) and Size (234). Below this is a 'Code Version' table with columns for Name, Executing Version, and Flash Version. The status bar at the bottom shows 'Comm Status' as green, 'UserID: root', and the library path 'Library:crimson11.central.sun.com'.

CAP Properties		
FRU Serial Number	PUX 96000063	
Size	234	

Code Version		
Name	Executing Version	Flash Version
aem.cramfs	5.12.14	5.12.14
disk.hbz.plmage	5.10.71	5.10.71
kernel.plmage	4.75.15	4.75.15
libs.cramfs	4.87.10	4.87.10
u-boot.bin	1.00.10	1.00.10

## ▼ Unlock a CAP or AEM Access Door

Normally a CAP or AEM access door is unlocked from a host. Use this procedure when you need to perform the unlock operation manually at the SL Console.

---

**Note** – If the CAP is reserved by a host, the host must release the CAP reservation before you can use this procedure.

---



---

**Note** – This screen is used for both rotational and AEM CAPs. Throughout this section, the term “CAP” refers to both types of CAPs.

---

1. Select Tools > Diagnostics.
2. Expand the CAP Folder, and click the CAP you want to modify.

---

**Note** – AEM CAPs are identified as follows: column “-31” for a left AEM CAP, and column “31” for a right AEM CAP.

---

3. Click the Access tab.

The Access screen appears.

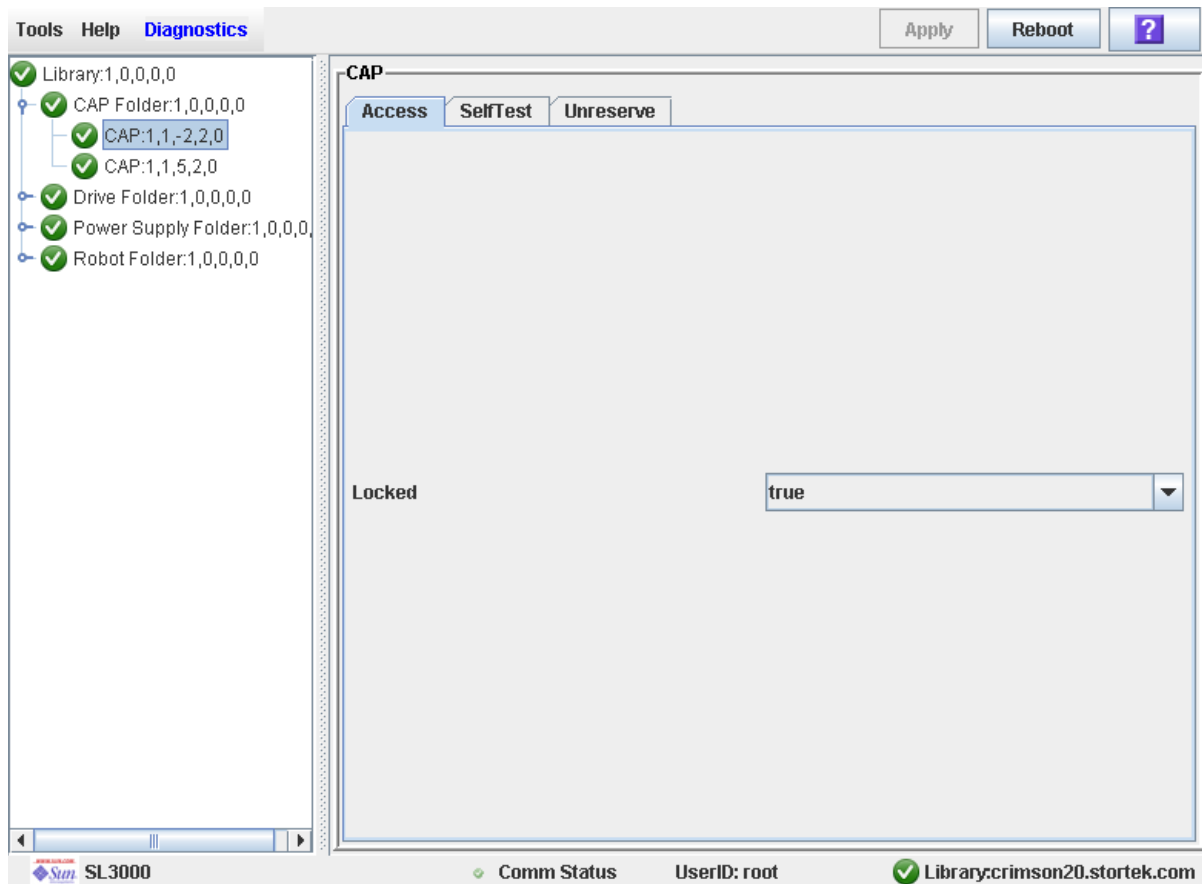

4. In the Locked pull-down, click false. Click the Apply button.

The Confirm popup appears.



5. Click OK.

The CAP door unlocks, and the CAP button light turns on.

---

**Note** – The CAP status changes to “unlocked” in the host library management software.

---

---

**Note** – The CAP or AEM is reserved by the library and inaccessible to all library hosts until you close and lock the CAP or AEM access door. See [“Lock a CAP or AEM Access Door”](#) on page 136 for details.

---

## ▼ Lock a CAP or AEM Access Door

Normally a CAP or AEM access door is locked from a host. Use this procedure when you need to perform the lock operation manually at the SL Console.

---

**Note** – This procedure applies only to HLI CAPs.

---

---

**Note** – This screen is used for both rotational and AEM CAPs. Throughout this section, the term “CAP” refers to both types of CAPs.

---

---

**Note** – If you unlock a CAP or AEM access door (see [“Unlock a CAP or AEM Access Door” on page 134](#) for details.), the CAP or AEM is reserved by the library and unavailable to all hosts until you perform this procedure.

---

1. **Select Tools > Diagnostics.**
2. **Expand the CAP Folder, and click the CAP you want to modify.**

---

**Note** – AEM CAPs are identified as follows: column “-31” for a left AEM CAP, and column “31” for a right AEM CAP.

---

**3. Click the Access tab.**

The Access screen appears.

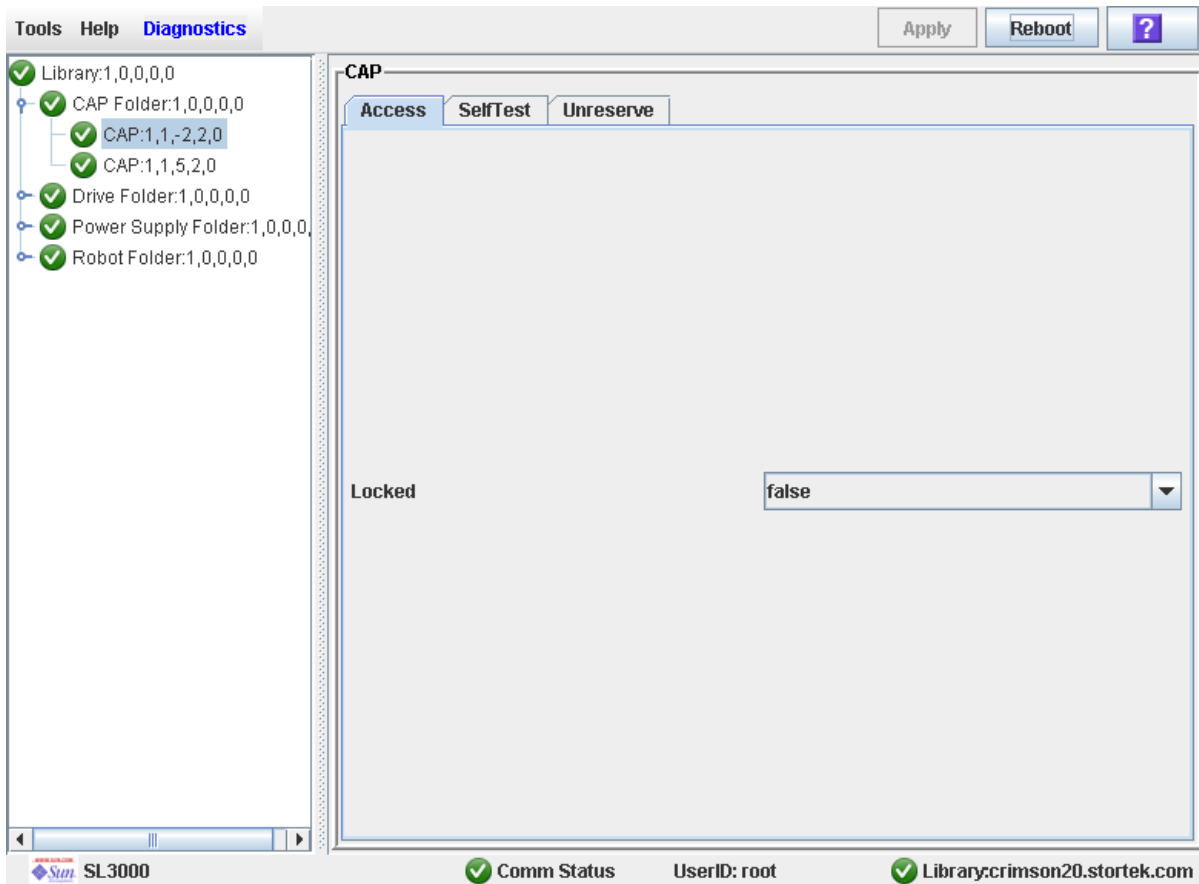
**4. In the Locked field, click True. Click the Apply button.**

The CAP locks, and the CAP button light turns off.

## ▼ Change the CAP Assignment Mode for an FC-SCSI Library

---

**Note** – This feature is available starting with SL3000 firmware version FRS\_2.33 and SL Console version FRS\_4.47.

---

Use this procedure to change the CAP assignment mode for all CAPs in an FC-SCSI library. The CAP assignment mode controls whether library CAPs can be used for normal host operations or for diagnostic moves. For additional information, see [“CAP Assignment Mode” on page 81](#).

---

**Note** – This procedure applies only to libraries with FC-SCSI host connections; it is not applicable to libraries that have only HLI (TCP/IP) host connections.

---



---

**Note** – This procedure applies to non-partitioned libraries only; it is not applicable to partitioned libraries.

---



---

**Note** – This screen is used for both rotational and AEM CAPs. Throughout this section, the term “CAP” refers to both types of CAPs.

---

1. **Verify that all library CAPs are in the following condition:**
  - Available – that is, not reserved by any host,
  - Empty, and
  - Closed and locked.
2. **If you are changing the CAPs to diagnostics mode, quiesce the library to all hosts. See the appropriate tape management software documentation for the procedures and commands.**
3. **Select Tools > CAP Assignment.**

The **CAP Assignment** screen appears. The pull-down displays the current assignment mode setting for all CAPs in the library.

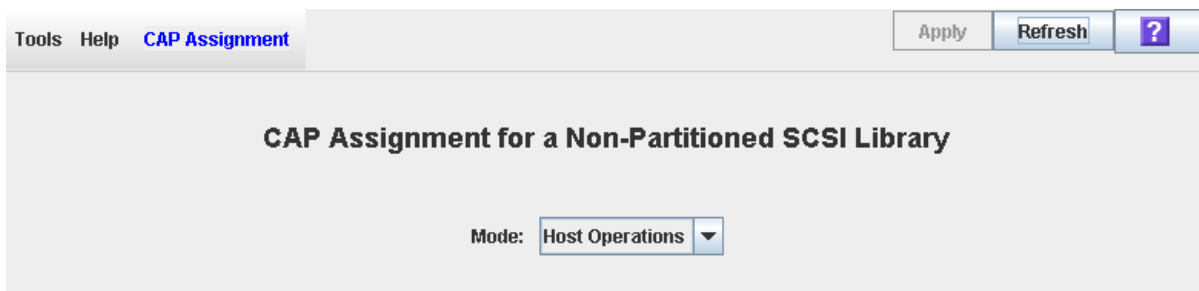

4. **In the pull-down, select the mode you want to assign, and click Apply.**

Options are:

  - **Diagnostics** – Makes all CAPs available for diagnostic operations. Select this if you want to perform manual cartridge moves, such as moving cleaning or diagnostic cartridges from the CAPs to reserved cells.

- Host Operations – Makes all CAPs available for normal host operations. Select this if you want to return the library to normal tape mount/dismount operations.

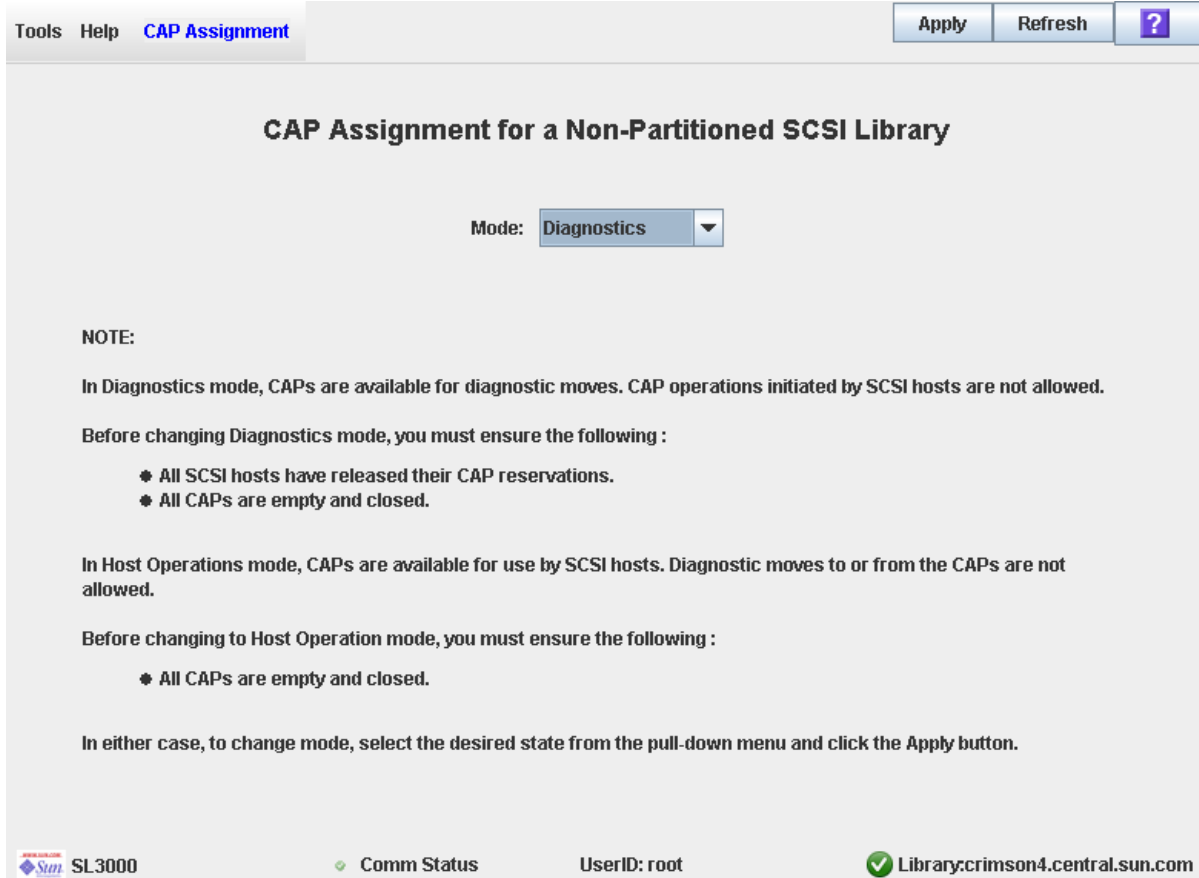

5. Click Apply.

A confirmation popup appears. The new CAP mode is effective immediately; the library does not need to be rebooted.

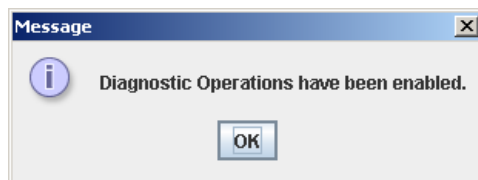

6. Click OK to dismiss the popup.

---

# Cartridge Management Tasks

<b>Task</b>	<b>Page</b>
<a href="#">Enter Cartridges Through a Rotational CAP</a>	141
<a href="#">Eject Cartridges Through a Rotational CAP</a>	142
<a href="#">Bulk Load Cartridges Through an AEM CAP</a>	143
<a href="#">Bulk Unload Cartridges Through an AEM CAP</a>	142
<a href="#">Configure Barcode Presentation in a Non-Partitioned FC-SCSI Library</a>	147
<a href="#">Configure Cartridge Barcode Presentation for an FC-SCSI Partition</a>	149
<a href="#">List Library Cartridges</a>	154
<a href="#">Locate a Cartridge by VOLID</a>	157
<a href="#">Locate a Cartridge by Address</a>	159
<a href="#">Move a Specified Cartridge by VOLID</a>	161
<a href="#">Move a Cartridge From a Specified Location</a>	163
<a href="#">Display the Media Events Report</a>	165



## ▼ Enter Cartridges Through a Rotational CAP

Use this procedure to enter cartridges into the library through a rotational CAP.

---

**Note** – This procedure applies to non-partitioned libraries. For partitioned libraries, see [“Enter Cartridges Into a Partition”](#) on page 326.

---



---

**Note** – For detailed instruction on loading cartridges through an AEM CAP, see [“Bulk Load Cartridges Through an AEM CAP”](#) on page 143.

---

1. **Initiate the enter operation at the host. See the appropriate tape management software documentation for the procedures and commands.**

---

**Note** – If the CAP is in auto enter mode, you can skip this step and proceed directly to [Step 2](#).

---

2. **Push the CAP button to open the CAP.**

The CAP door opens.

---

**Caution** – *Possible Equipment Damage.* DO NOT force the CAP to open or close.

---

3. **Place the cartridges in the CAP.**

Insert the cartridges so that the customer label (if present) is facing up, the hub gear is facing down, and the cartridge label is facing you.

You can enter the cartridges directly into the magazines while the magazines are in the CAP; or you can remove the magazines from the CAP, insert cartridges into the magazines, and then replace the cartridge-filled magazines into the CAP.

---

**Note** – Cartridges may be placed in any CAP slot, in any order; the TallBot audits all CAP slots when the CAP door closes.

---



---

**Caution** – *Possible Media Damage.* While cartridges that do not contain external labels or are placed upside-down can be entered, this is not advisable. It presents problems when an audit is performed. Likewise, cartridges that contain unreadable or damaged labels should not be entered.

---

4. **Push the CAP button to close the CAP.**

The CAP closes and locks automatically, and the CAP button light turns off.

---

**Caution** – *Possible Equipment Damage.* DO NOT force the CAP to open or close.

---

5. **The TallBot audits the CAP and then moves the cartridges from the CAP to storage slots within the appropriate partition.**

When all cartridges have been moved from the CAP, the library recognizes that the CAP is empty and the CAP is returned to its default state.

## ▼ Eject Cartridges Through a Rotational CAP

Use this procedure to eject cartridges from the library through a rotational CAP.

---

**Note** – This procedure applies to non-partitioned libraries. For partitioned libraries, see [“Eject Cartridges From a Partition” on page 327](#).

---



---

**Note** – For detailed instruction on unloading cartridges through an AEM CAP, see [“Bulk Unload Cartridges Through an AEM CAP” on page 145](#).

---

**1. Initiate the eject operation at the host. See the appropriate tape management software documentation for the procedures and commands.**

You must specify the VOLIDs of the cartridges you want to remove from the library. For HLI hosts, you can specify the CAPs to use. For FC-SCSI hosts, the library uses CAPs in a pre-defined order; see [“CAP Priorities for Cartridge Ejects by FC-SCSI Hosts” on page 81](#) for details.

**2. The TallBot places the cartridges into the CAPs.**

When all the requested cartridges have been placed in CAPs, or all CAPs are full, the CAPs are unlocked.

**3. Push the CAP button to open the CAP.**

The CAP door opens.

---

**Caution** – *Possible Equipment Damage*. DO NOT force the CAP to open or close.

---

**4. Remove the cartridges from the CAP.**

You can remove the cartridges directly from the magazines while the magazines are in the CAP; or you can take the magazines out of the CAP, remove the cartridges from the magazines, and then replace the empty magazines in the CAP.

---

**Note** – If you do not replace the magazines in the CAP, the cells will be marked “absent” by the library controller.

---

**5. Push the CAP button to close the CAP.**

The CAP closes and locks automatically, and the CAP button light turns off.

---

**Caution** – *Possible Equipment Damage*. DO NOT force the CAP to open or close.

---

If more cartridges need to be exported, the TallBot continues filling the necessary CAPs. Wait until the CAP door is unlocked and repeat [Step 3](#) through [Step 5](#).

The eject operation ends automatically when all specified cartridges have been ejected.

**6. The TallBot audits the CAP to verify that it is empty.**

The CAP is then returned to its default state.

## ▼ Bulk Load Cartridges Through an AEM CAP

Use this procedure to load cartridges into the library through an AEM CAP. You can load up to 234 cartridges at a time.

---

**Note** – This procedure applies to non-partitioned libraries. For partitioned libraries, see [“Enter Cartridges Into a Partition” on page 326](#).

---



---

**Note** – For detailed instruction on entering cartridges through a rotational CAP, see [“Enter Cartridges Through a Rotational CAP” on page 141](#).

---

1. **Initiate the enter operation at the host. See the appropriate tape management software documentation for the procedures and commands.**

---

**Note** – If the AEM CAP is in auto enter mode, you can skip this step and proceed directly to [Step 2](#).

---

The **Unlocked** light on the AEM access door is lit.

2. **Push the AEM CAP button.**

The **Wait** light on the AEM access door starts blinking as all in-process jobs are finished. The robot is cleared from the AEM, and the safety door comes down. Depending on the level of activity in the library, this may take several minutes.

Once the safety door is completely down and the AEM is sealed, the **Wait** light stops blinking and the **Enter** light goes on solid.

3. **Lift the latch, and open the door.**

---

**Caution** – *Possible Equipment Damage*. DO NOT force the AEM access door to open or close.

---

4. **Place the cartridges in the AEM CAP.**

Insert the cartridges so that the customer label (if present) is facing up, the hub gear is facing down, and the cartridge label is facing you.

You can enter the cartridges directly into the magazines while the magazines are in the CAP; or you can remove the magazines from the CAP, insert cartridges into the magazines, and then replace the cartridge-filled magazines into the CAP.

---

**Note** – Cartridges may be placed in any CAP slot, in any order; the TallBot audits all CAP slots when the CAP door closes.

---



---

**Caution** – *Possible Media Damage*. While cartridges that do not contain external labels or are placed upside-down can be entered, this is not advisable. It presents problems when an audit is performed. Likewise, cartridges that contain unreadable or damaged labels should not be entered.

---

---

**Caution** – *Possible Equipment Damage.* When replacing magazines on the AEM walls, make sure you seat them correctly.

---

**5. Close and latch the AEM access door.**

---

**Caution** – *Possible Equipment Damage.* DO NOT force the AEM access door to open or close.

---

**6. Push the AEM CAP button.**

The **Enter** light goes off, and the **Wait** light starts blinking.

The safety door goes up.

**7. The robot moves into the AEM, audits the AEM CAP, and then moves the cartridges from the AEM CAP to available storage cells.**

When all cartridges have been moved from the AEM CAP, the library recognizes that the AEM is empty and it is returned to its default state.

## ▼ Bulk Unload Cartridges Through an AEM CAP

Use this procedure to unload cartridges from the library through an AEM CAP. You can unload up to 234 cartridges at a time.

---

**Note** – For eject operations initiated from an FC-SCSI host, AEM CAPs are used only after all rotational CAPs have been filled. See [“CAP Priorities for Cartridge Ejects by FC-SCSI Hosts” on page 81](#) for complete details.

---

**Note** – This procedure applies to non-partitioned libraries. For partitioned libraries, see [“Eject Cartridges From a Partition” on page 327](#).

---

**Note** – For detailed instruction on ejecting cartridges through a rotational CAP, see [“Eject Cartridges Through a Rotational CAP” on page 142](#).

---

**1. Initiate the eject operation at the host. See the appropriate tape management software documentation for the procedures and commands.**

You must specify the VOLIDs of the cartridges you want to remove from the library. For HLI hosts, you can specify the AEM CAPs to use. For FC-SCSI hosts, the library uses rotational and AEM CAPs in a pre-defined order; see [“CAP Priorities for Cartridge Ejects by FC-SCSI Hosts” on page 81](#) for details.

**2. The TallBot places the cartridges into the AEM cells.**

When all the requested cartridges have been placed in the AEM, the AEM is unlocked and the **Unlocked** light on the AEM access door is lit.

**3. Push the AEM CAP button.**

The **Wait** light on the AEM access door starts blinking as all in-process jobs are finished. The TallBot is cleared from the AEM, and the safety door comes down. Depending on the level of activity in the library, this may take several minutes.

Once the safety door is completely down and the AEM is sealed, the **Wait** light stops blinking and the **Enter** light goes on solid.

**4. Lift the latch, and open the door.**

---

**Caution** – *Possible Equipment Damage.* DO NOT force the CAP to open or close.

---

**5. Remove the cartridges from the AEM CAP.**

You can remove the cartridges directly from the magazines while the magazines are in the AEM; or you can take the magazines out of the AEM, remove the cartridges from the magazines, and then replace the empty magazines in the AEM.

---

**Caution** – *Possible Equipment Damage.* When replacing magazines on the AEM walls, make sure you seat them correctly.

---

---

**Note** – If you do not replace the magazines in the AEM, the cells will be marked “absent” by the library controller.

---

**6. Close and latch the AEM access door.**

---

**Caution** – *Possible Equipment Damage.* DO NOT force the AEM access door to open or close.

---

**7. Push the AEM CAP button.**

The **Enter** light goes off, and the **Wait** light starts blinking.

The safety door goes up.

**8. If more cartridges need to be exported, the TallBot continues filling the necessary AEMs. Wait until the AEM Unlocked light is lit and repeat Step 3 through Step 6.**

The eject operation ends automatically when all specified cartridges have been ejected.

The TallBot moves into the AEM and audits the AEM CAP to verify that it is empty.

The AEM CAP is then returned to its default state.

---

**Note** – The audit of the AEM CAP should take less than three minutes.

---

## ▼ Configure Barcode Presentation in a Non-Partitioned FC-SCSI Library

---

**Note** – This feature is available starting with SL3000 firmware version FRS\_2.33 and SL Console version FRS\_4.47.

---

Use this procedure to configure the cartridge barcode presentation format for an FC-SCSI library. This specifies which part of a cartridge barcode the library passes to host applications that use the FC-SCSI interface.

---

**Note** – This procedure applies only to libraries with FC-SCSI host connections; it is not applicable to libraries that have only HLI (TCP/IP) host connections.

---



---

**Note** – This procedure applies to non-partitioned libraries only. For partitioned libraries, see [“Configure Cartridge Barcode Presentation for an FC-SCSI Partition”](#) on page 149.

---

### 1. Select Tools > Configuration.

The **Library Configuration** screen appears.

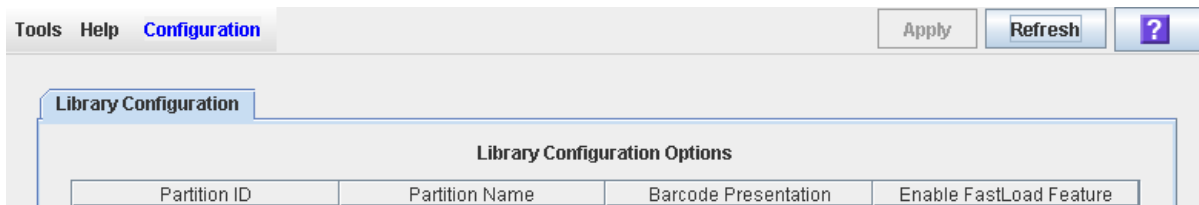

### 2. In the Barcode Presentation pull-down, select the presentation format you want to use for the entire library.

---

**Note** – The Partition Name “scsi0” indicates a non-partitioned library.

---

Options are:

- all – All eight barcode characters are passed to host applications.

- left6 – Only the six VOLID characters, which are on the left side of the barcode, are passed to host applications. The domain and type characters, which are the two characters on the right, are not passed. This is the default setting.

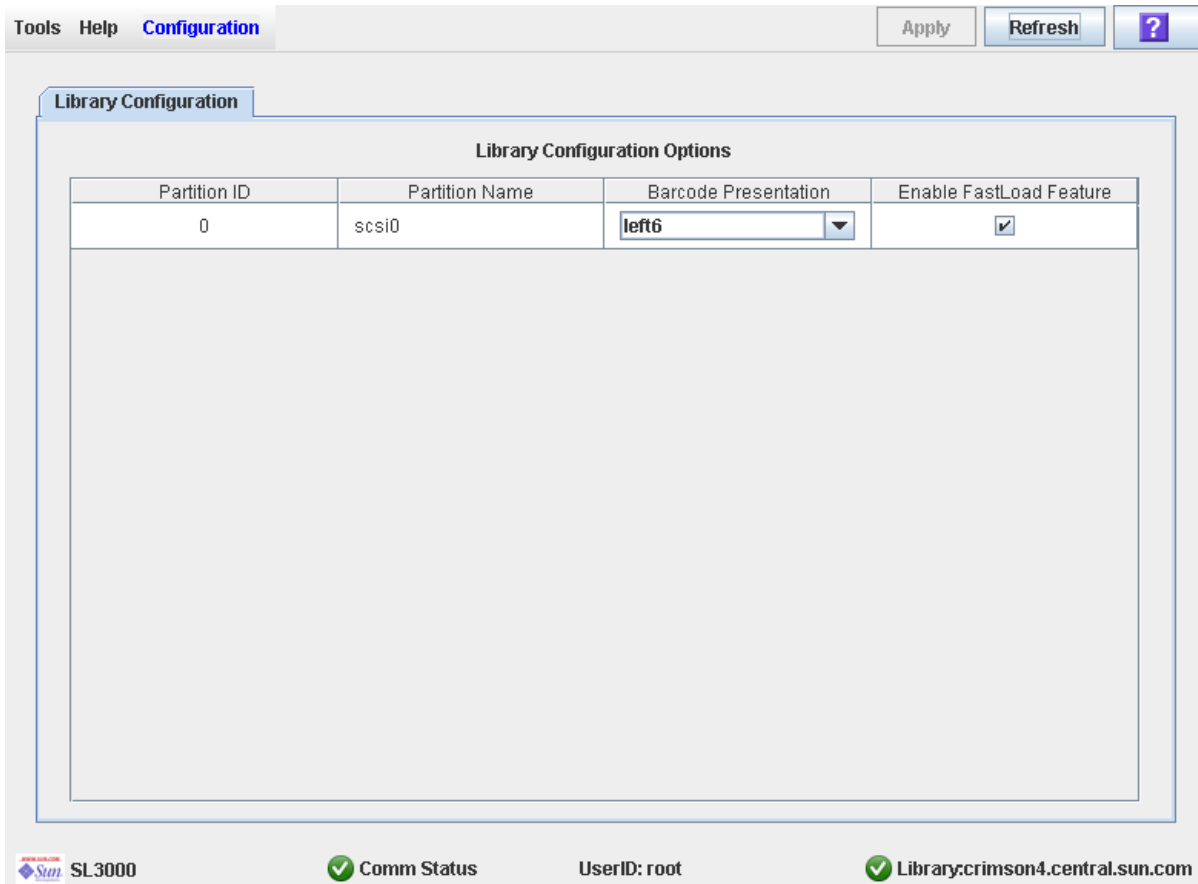

**3. Click Apply.**

A confirmation popup appears. The new barcode presentation setting is effective immediately; the library does not need to be rebooted.

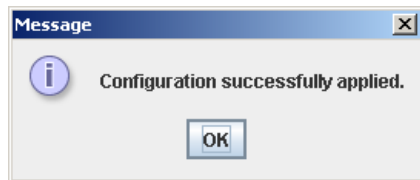

**4. Click OK to dismiss the popup.**



## ▼ Configure Cartridge Barcode Presentation for an FC-SCSI Partition

---

**Note** – This feature is available starting with SL3000 firmware version FRS\_2.33 and SL Console version FRS\_4.47.

---

Use this procedure to configure the cartridge barcode presentation format for an FC-SCSI partition. This specifies which part of a cartridge barcode the library passes to host applications accessing the partition. For details on this feature, see [“Barcode Presentation” on page 88](#).

You can assign different presentation methods to each library partition.

---

**Note** – This procedure applies only to libraries with FC-SCSI host connections; it is not applicable to libraries that have only HLI (TCP/IP) host connections.

---



---

**Note** – This procedure applies to partitioned libraries only. For non-partitioned libraries, see [“Configure Barcode Presentation in a Non-Partitioned FC-SCSI Library” on page 147](#).

---

### 1. Select Tools > Configuration.

The **Library Configuration** screen appears.

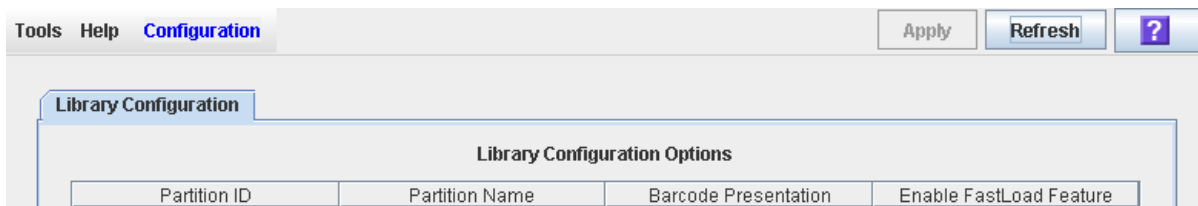

### 2. In the partition Barcode Presentation pull-down, select the presentation format you want to use for that partition. You can use multiple pull-downs to select settings for more than one partition at a time.

Options are:

- all – All eight barcode characters are passed to host applications.

- left6 – Only the six VOLID characters, which are on the left side of the barcode, are passed to host applications. The domain and type characters, which are the two characters on the right, are not passed. This is the default setting.

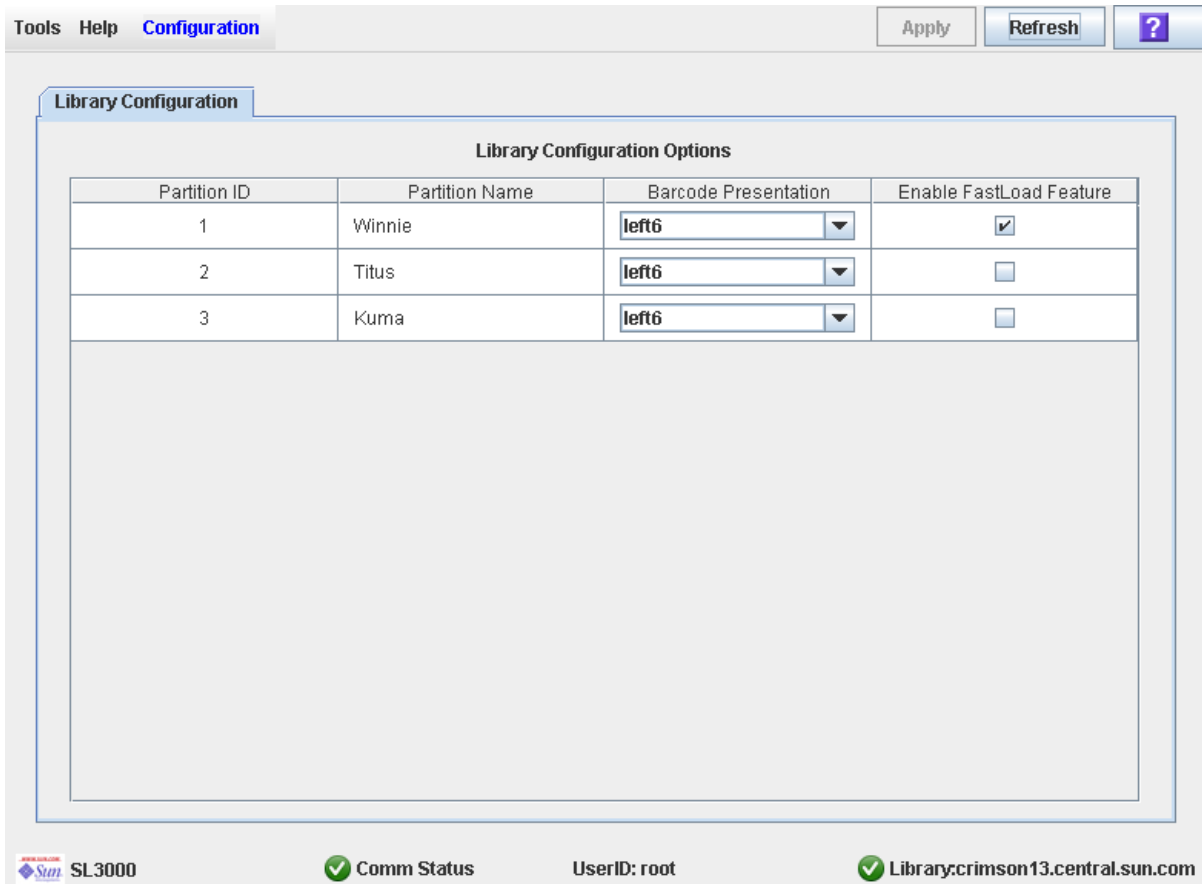

3. Click **Apply**.

A confirmation popup appears. The new barcode presentation settings are effective immediately; the library does not need to be rebooted.

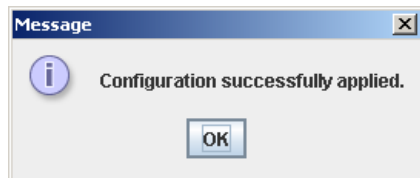

4. Click **OK** to dismiss the popup.

## ▼ Display Library Cartridge Information in Tabular Format

---

**Note** – This feature is available starting with SL3000 firmware version FRS\_2.33 and SL Console version FRS\_4.47.

---

Use this procedure to display detailed information about all library cartridges in a sortable, tabular format. Information includes the cartridge VOLIDs, locations, and media types. You can use this report for a variety of purposes, such as:

- Locate cartridges by library internal address
- Verify that all cartridges in the library have valid, readable barcode labels
- Identify cleaning and diagnostic cartridges
- Identify cartridge media types in a mixed-media library

---

**Note** – You can modify the layout and display of this screen. See [“Modifying the Screen Layout” on page 36](#) for details.

---



---

**Note** – To display most of the same data in a straight text format, see [“List Library Cartridges” on page 154](#).

---

### 1. Select Tools > Reports.

All library report options are listed in the navigation bar.

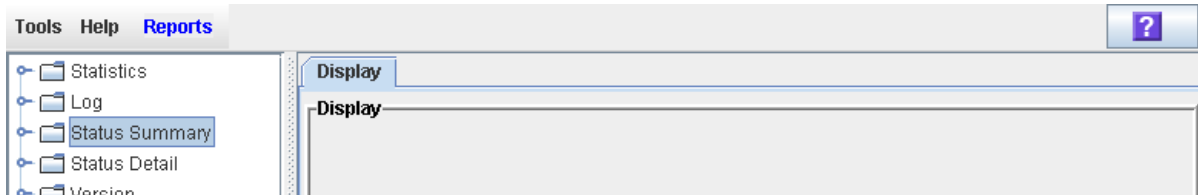

### 2. Expand the Status Summary folder.

All Status Summary reports are listed.

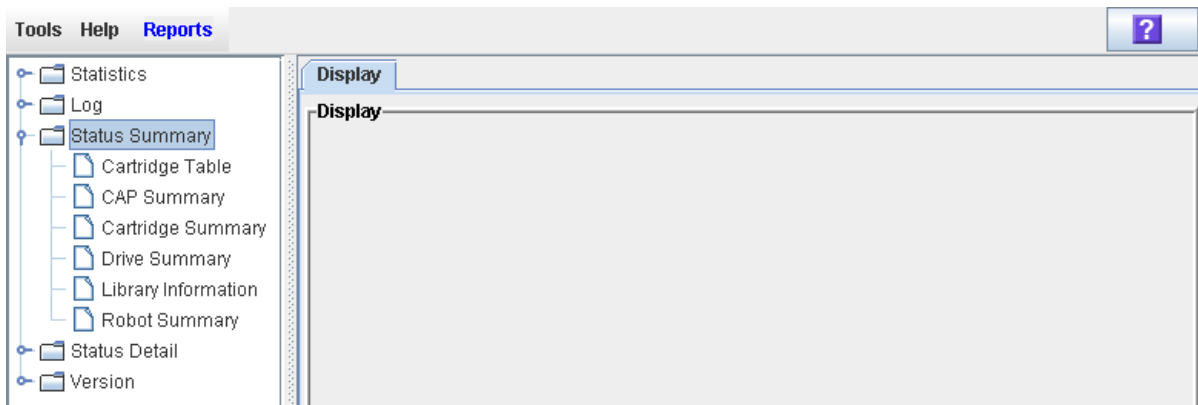

### 3. Click Cartridge Table.

The Cartridge Table Report is displayed. See “Screen Fields” below for a detailed description of each screen field.

lib	rail	col	side	row	Location Type	Media Type	Type	Label	Custom Label
1	1	2	2	21	cell	9940	data	W000780P	
1	1	-3	1	20	cell	LtoGen2_200GB	data	T02008L2	
1	1	2	2	34	cell	LtoGen3_400GB	data	STK335L3	
1	1	-4	2	30	cell	SDLT-2	data	STK07212	
1	1	2	1	25	cell	SDLT-2	data	STK06412	
1	1	-5	2	22	cell	SDLT-2	data	STK04812	
1	1	-3	2	18	cell	SDLT-2	data	STK03212	
1	1	3	2	28	cell	LtoGen4_800GB	data	PQ4708L4	
1	1	3	2	22	cell	LtoGen4_800GB	data	PQ4707L4	
1	1	3	2	21	cell	LtoGen4_800GB	data	PQ4705L4	
1	1	-2	1	21	cell	LtoGen1_100GB	data	PQ1342L1	
1	1	2	1	13	cell	LtoGen1_100GB	data	PQ1340L1	
1	1	-5	2	33	cell	9840_R	data	M068050R	
1	1	-4	2	34	cell	9840_R	data	M064860R	
1	1	9	2	13	cell	9840_R	data	M061700R	
1	1	-8	1	10	cell	9840_R	data	M061510R	
1	1	2	2	19	cell	9840_R	data	M058710R	
1	1	3	1	19	cell	9840_R	data	M012030R	
1	1	-4	2	28	cell	9840_R	data	M010900R	
1	1	-5	1	19	cell	LtoGen3_400GB	data	LT3237L3	
1	1	-3	2	2	cell	LtoGen3_400GB	data	LT3182L3	
1	1	3	1	28	cell	LtoGen3_400GB	data	LT3181L3	
1	1	7	1	27	cell	LtoGen3_400GB	data	LT3175L3	
1	1	2	2	24	cell	LtoGen3_400GB	data	LT3155L3	
1	1	7	2	12	cell	LtoGen3_400GB	data	LT3154L3	
1	1	-7	2	19	cell	LtoGen3_400GB	data	LT3152L3	
1	1	4	1	28	cell	LtoGen3_400GB	data	LT3138L3	
1	1	-8	2	28	cell	LtoGen3_400GB	data	LT3135L3	
1	1	9	1	15	cell	LtoGen2_200GB	data	LT2345L2	

### 4. If you want to search the report data or save it to a file, see the following procedures:

- “Search a Library Report” on page 116
- “Save Library Report Data to a File” on page 118

## Screen Fields

### lib, rail, col, side, row

Display only.

Library, rail, column, side, and row. Together these values identify the library internal address where the cartridge is located.

For a detailed description of the library internal address format, see “Library Internal Address” on page 493.

### Location Type

Display only.

Type of library location where the cartridge is located. Options are:

- CAP – Rotational or AEM CAP cell
- cell – Regular storage cell
- drive – Loaded in a tape drive
- sysCell – System (reserved) cell; cleaning or diagnostic cartridges are typically stored in these cells

**Media Type**

Display only.

Type of media in the cartridge. For example, Lto Gen2\_200GB, SDLT-2, 9840\_R.

**Type**

Display only.

Domain, or usage type, of the cartridge. Options are:

- clean – Cleaning cartridge
- data – Data cartridge
- diagnostic – Diagnostic cartridge

**Label**

Display only.

Unique VOLID of the cartridge. Standard VOLIDs are eight characters in length.

A value of #UREAD indicates the barcode label is unreadable. Possible reasons for this are as follows:

- The label is missing, damaged, or upside-down. In this case, the **Custom Label** field also indicates #UREAD.
- The label has a non-standard format, such as a ten-character VOLID, or an unrecognized cartridge domain or media type indicator. In this case, the non-standard VOLID is displayed in the **Custom Label** field.

The library controller does not allow you to mount an unlabeled or unknown type cartridge into any tape drive.

**Custom Label**

Display only.

Non-standard VOLID of the cartridge, if applicable. Possible entries for this field are as follows:

- Blank – The cartridge has a readable, standard eight-character VOLID cartridge label, as indicated in the **Label** field.
- #UREAD – The cartridge label is truly not readable, possibly because it is missing, damaged, or upside-down.
- Any other value – Indicates the non-standard VOLID of the cartridge.

## ▼ List Library Cartridges

Use this procedure to display information about all library cartridges, including their VOLIDs, locations, and media types.

---

**Note** – To display the same data in a tabular format, see [“Display Library Cartridge Information in Tabular Format”](#) on page 151

---

**1. Select Tools > Reports.**

All library report options are listed in the navigation bar.

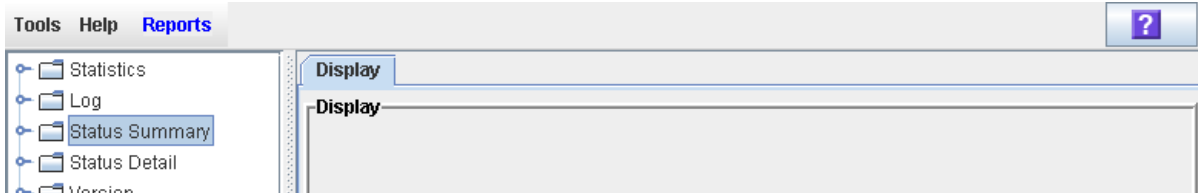

**2. Expand the Status Summary folder.**

All Status Summary reports are listed.

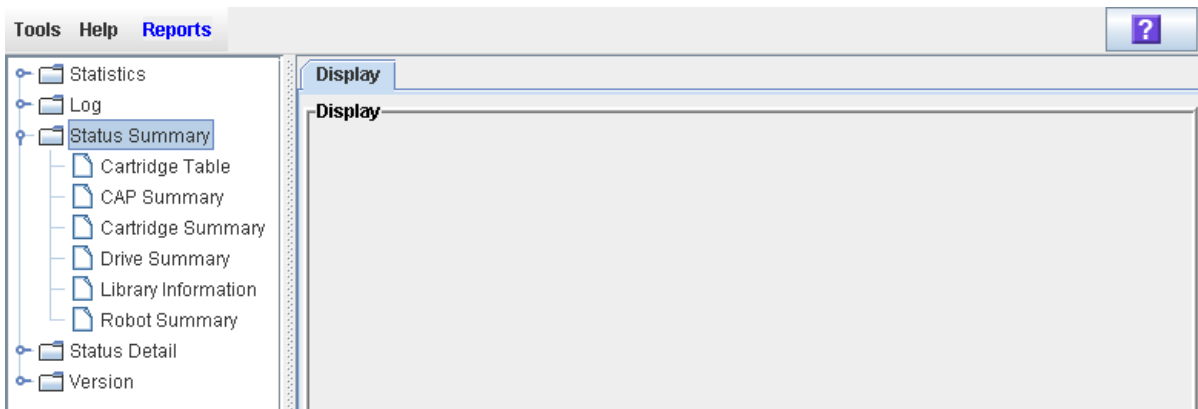

### 3. Click Cartridge Summary.

The Cartridge Summary Report is displayed. See [“Screen Fields”](#) below for a detailed description of each screen field.

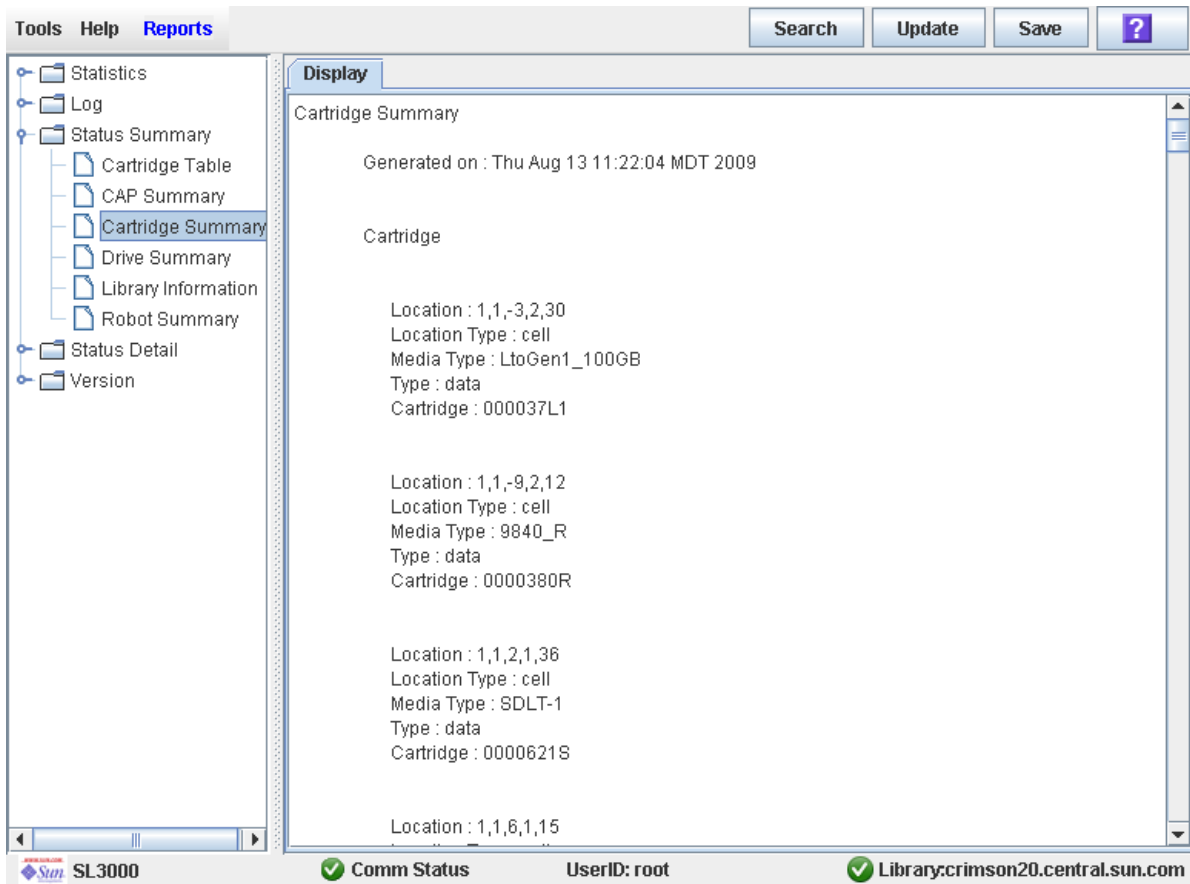

### 4. If you want to search the report data or save it to a file, see the following procedures:

- [“Search a Library Report” on page 116](#)
- [“Save Library Report Data to a File” on page 118](#)

## Screen Fields

### Location

Display only.

Library, rail, column, side, and row. Together these values identify the library internal address where the cartridge is located.

For a detailed description of the library internal address format, see [“Library Internal Address” on page 493](#).

### Location Type

Display only.

Type of library location where the cartridge is located. Options are:

- CAP – Rotational or AEM CAP cell
- cell – Regular storage cell

- drive – Loaded in a tape drive
- sysCell – System (reserved) cell; cleaning or diagnostic cartridges are typically stored in these cells

**Media Type**

Display only.

Type of media in the cartridge. For example, Lto Gen2\_200GB, SDLT-2, 9840\_R.

**Type**

Display only.

Domain, or usage type, of the cartridge. Options are:

- clean – Cleaning cartridge
- data – Data cartridge
- diagnostic – Diagnostic cartridge

**Cartridge**

Display only.

Unique VOLID of the cartridge. Standard VOLIDs are eight characters in length.

A value of #UREAD indicates the barcode label is unreadable. Possible reasons for this are as follows:

- The label is missing or damaged.
- The label has a non-standard format, such as a ten-character VOLID, or an unrecognized cartridge domain type or media type indicator.

The library controller does not allow you to mount an unlabeled or unknown type cartridge into any tape drive. See [“Cartridge Management” on page 87](#) for additional details.



## ▼ Locate a Cartridge by VOLID

Use this procedure to display the current location of a cartridge with a specified volume ID. The location can be displayed in one of the following formats:

- Library internal address
- HLI-PRC address (HLI hosts only)

1. **Select Tools > Diagnostics, and click the Library folder.**

2. **Click the Search tab.**

The **Library Search** screen appears.

3. **In the Search Type pull-down, click VOLID.**

4. **Enter the VOLID, Requester, and Cartridge Type.**

The **Requester** field controls the address format that will be displayed for the cartridge location.

- To display the library internal address, click `default`.
- To display the HLI-PRC address, click `hli0` or `hli1`.

---

**Note** – You can use wildcards in the VOLID field.

---

5. Click Search.

The screen displays all cartridges meeting the search criteria.

The screenshot shows the SL3000 interface with the 'Diagnostics' tab selected. The 'Library' section on the left lists several folders with green checkmarks. The main window displays search filters: 'VOLID' selected in the 'Search Type' dropdown, 'LT31\*' in the search text field, 'default' in the 'Requester' dropdown, and 'data' in the 'Cartridge Type' dropdown. Below these filters is a 'Search Result' table with five rows of data.

VOLID	Internal Address	Location Type	Media Type	Cartridge Type
LT3135L3	1,1,-9,1,47	cell	LtoGen3_400GB	data
LT3138L3	1,1,5,2,11	cap	LtoGen3_400GB	data
LT3161L3	1,1,-8,2,49	cell	LtoGen3_400GB	data
LT3181L3	1,1,-7,1,1	cell	LtoGen3_400GB	data
LT3182L3	1,1,-7,1,3	cell	LtoGen3_400GB	data

At the bottom of the interface, the status bar shows 'Comm Status' with a green checkmark, 'UserID: root', and 'Library:crimson20.stortek.com' with a green checkmark.

## ▼ Locate a Cartridge by Address

Use this procedure to display detailed information for cartridges with a specified location. Wildcards allow you to display all cartridges in a specified general area (for example, in a specified panel, row, or column). You can specify the location using one of the following formats:

- Library internal address
- HLI-PRC address (HLI hosts only)
- FC-SCSI address (FC-SCSI hosts only)

1. **Select Tools > Diagnostics, and click the Library folder.**

2. **Click the Search tab.**

The **Library Search** screen appears.

3. **In the Search Type pull-down, click Location.**

---

**Note** – The default Search Type is VOLID.

---

The screen is updated to display fields allowing you to search by location.

4. **In the Location pull-down, select the type of match you want to perform in the search.**

5. **In the Requester pull-down, select the type of address format you want to use for the search.**

6. **In the Location field, enter the parameters for the search.**

The format you use must correspond to the **Requester** you have specified. For example:

- Use the library internal address format if **Requester** is “default”.
- Use the HLI-PRC address if **Requester** is an HLI host.
- Use the FC-SCSI address if **Requester** is an FC-SCSI host.

---

**Note** – You cannot use wildcards in this field.

---

7. Click the Search button.

The screen displays all locations meeting the search criteria.

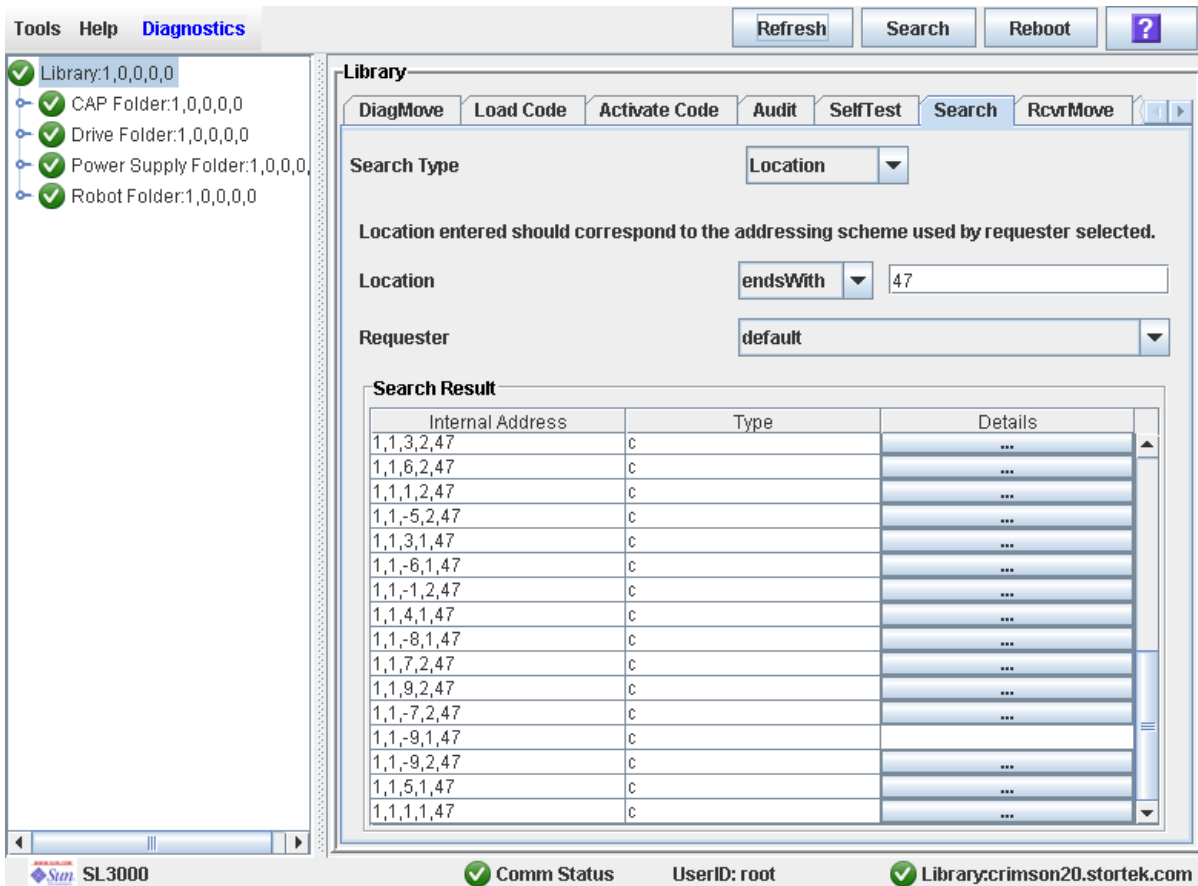

8. To see details about a cartridge or to view a location mapping, click the ... button in the Details column.

The Location Details screen appears.

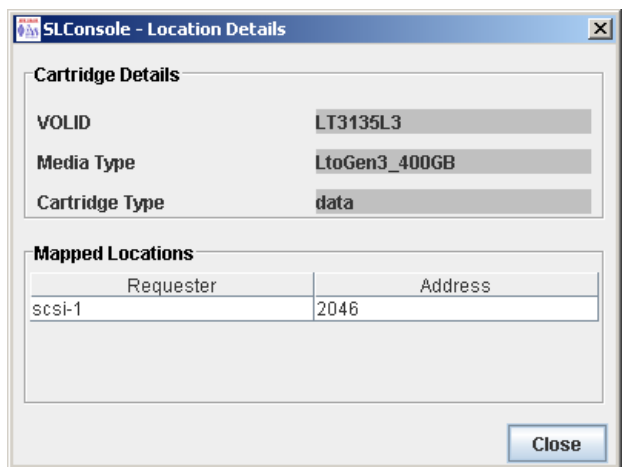

9. Click Close to dismiss the popup.

## ▼ Move a Specified Cartridge by VOLID

Use this procedure to move a cartridge with a specified VOLID to a specified location within the library.

---

**Note** – This procedure updates the cartridge’s location in the library controller database, but not in the host database. Therefore after performing this procedure, you must perform an audit from the host software to update the host database. Failure to do so will cause future mount requests from the host software to fail.

---



---

**Caution** – Use caution when performing this procedure in partitioned libraries. You could inadvertently move a cartridge from one partition to another, allowing the new partition to overwrite data on the cartridge.

---

1. **Select Tools > Diagnostics, and click the Library folder.**
2. **Click the RcvrMove tab.**  
The Recovery Move screen appears.
3. **In the Source Location Mode field, click VOLID.**  
The screen is updated with the appropriate **Source Location** fields.
4. **In the VOLID field, specify the VOLID of the cartridge you want to move.**
5. **In the Destination Location Type pull-down menu, select the type of location where you want to move the cartridge to. Options are:**
  - CAP
  - Storage Slots
  - Drive
  - Reserved Slots

The following restrictions apply:

  - The destination can be a drive only if the source is a CAP or reserved slot.
  - For you to move a cartridge to a drive, the cartridge media type must be compatible with the drive type.
  - You cannot move a cartridge to a location that is already occupied.
  - Although not strictly enforced, it is recommended that only diagnostic or cleaning cartridges be moved to reserved slots.
6. **In the Destination Location table, specify the library internal address of the destination location by making the appropriate selections in the following pull-down menus:**  
The following special selections are available on the pull-down menus:
  - Min—First element of that location type—in the library
  - Max—Last element of that location type—in the library

---

**Caution** – If the library is partitioned, make sure to keep the cartridge in the same partition it is currently allocated to. Moving a cartridge to a cell allocated to a different partition could result in a host treating the cartridge as scratch and overwriting the data. Moving the cartridge to an unallocated cell will result in the cartridge being inaccessible to all hosts.

---

7. Click the Start button in the Options Bar.

The robot moves the cartridge. A success message popup appears when the operation is complete.

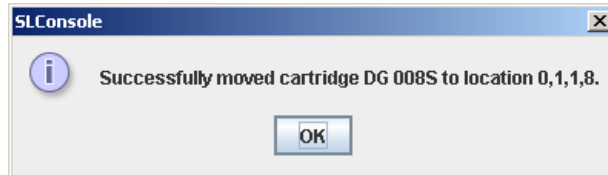

8. Click OK.

9. To verify the new location, you can display a Cartridge Summary Report. See ["List Library Cartridges"](#) on page 154 for details. For example:

10. To update the new cartridge location in the host database, initiate a library audit from the host software. See the appropriate tape management software documentation for the procedures and commands.

## ▼ Move a Cartridge From a Specified Location

Use this procedure to move a cartridge from one specified location to another within the library.

---

**Note** – This procedure updates the cartridge’s location in the library controller database, but not in the host database. Therefore after performing this procedure, you must perform an audit from the host software to update the host database. Failure to do so will cause future mount requests from the host software to fail.

---



---

**Caution** – Use caution when performing this procedure in partitioned libraries. You could inadvertently move a cartridge from one partition to another, allowing the new partition to overwrite data on the cartridge.

---

1. **Select Tools > Diagnostics, and click the Library folder.**
2. **Click the RcvrMove tab.**  
The Recovery Move screen appears.
3. **In the Source Location Mode field, click Location.**  
The screen is updated with the appropriate **Source Location** fields.
4. **In the Source Location Type pull-down menu, select the cartridge’s current location type. Options are:**
  - CAP
  - Slot
  - Drive
  - Reserved Slots
5. **In the Source Location table, specify the library internal address of the source location by making the appropriate selections in the following pull-down menus:**  
The following special selections are available on the pull-down menus:
  - Min—First element of that location type—in the library
  - Max—Last element of that location type—in the library
6. **In the Destination Location Type pull-down menu, select the type of location where you want to move the cartridge to. Options are:**
  - CAP
  - Storage Slots
  - Drive
  - Reserved Slots

The following restrictions apply:

  - The destination location can be a drive only if the source is a CAP or reserved slot.
  - For you to move a cartridge to a drive, the cartridge media type must be compatible with the drive type.
  - You cannot move a cartridge to a location that is already occupied.
  - Although not strictly enforced, it is recommended that only diagnostic or cleaning cartridges be moved to reserved slots.

7. In the **Destination Location** table, specify the library internal address of the destination location by making the appropriate selections in the following pull-down menus:

The following special selections are available on the pull-down menus:

- Min—First element of that location type—in the library
- Max—Last element of that location type—in the library

---

**Caution** – If the library is partitioned, make sure to keep the cartridge in the same partition it is currently allocated to. Moving a cartridge to a cell allocated to a different partition could result in a host treating the cartridge as scratch and overwriting the data. Moving the cartridge to an unallocated cell will result in the cartridge being inaccessible to all hosts.

---

8. Click the **Start** button in the **Options Bar**.

The robot moves the cartridge, and then a success message popup appears.

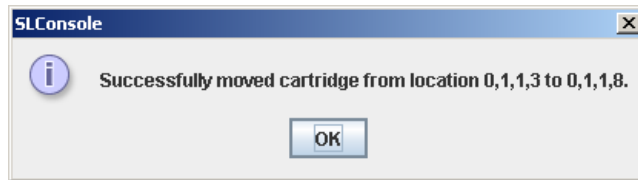

9. Click **OK**.
10. To verify the new location, you can display a **Cartridge Summary Report**. See ["List Library Cartridges"](#) on page 154 for details. For example:
11. To update the new cartridge location in the host database, initiate a library audit from the host software. See the appropriate tape management software documentation for the procedures and commands.



## ▼ Display the Media Events Report

**Note** – This feature is available starting with SL3000 firmware version FRS\_2.30 and SL Console version FRS\_4.30.

The Media Events Report summarizes library cartridge media events. The report is updated whenever a media event or error occurs on any drive. You can use the report to help identify and diagnose faulty cartridges.

For each cartridge that has experienced media events, the report lists the VOLID of the cartridge, the type of event, the number of occurrences, and the date and time of the last such event. The report can display up to 2000 entries.

By default, the report is sorted in VOLID order. Optionally, you can change the sort order, and rearrange and resize the columns. See [“Modifying the Screen Layout” on page 36](#).

**Note** – For cartridge events associated with particular drives, see [“Display the Drive Media Events Report” on page 178](#).

1. Select **Tools > Reports**.
2. Expand the **Statistics** folder, and click **Media Events**.

The screenshot shows the SL3000 console interface. The top menu bar includes 'Tools', 'Help', and 'Reports'. Below the menu are buttons for 'Search', 'Update', 'Save', and a help icon. The left sidebar shows a tree view with 'Statistics' expanded, and 'Media Events' selected. The main window displays a table with the following data:

Cartridge Label	Event Type	Number of Events	Last Seen
ACS168L2	Media Error	63	Sat Feb 14 10:15:19 MS...

The bottom status bar shows 'SL3000', 'Comm Status' (green checkmark), 'UserID: root', and 'Library:crimson1.central.sun.com' (red exclamation mark).

## Screen Fields

### **Cartridge Label**

VOLID of the cartridge that has experienced an event.

### **Event Type**

Type of media event being tracked. Options are:

- Media Error – The drive indicated there was a problem with the media; this could possibly also indicate a problem with the drive.
- Misbuckle Error – The drive was unable to grab the buckle of the media and could not thread the tape. The media is likely damaged.

### **Number of Events**

Total number of events of this type that have been recorded for this cartridge.

### **Last Seen**

Date and time of the most recent occurrence of the event.

---

# Drive Management Tasks

<b>Task</b>	<b>Page</b>
Display Drive Summary Information	168
Display Drive Status	170
Display Drive Properties	171
Display Drive VOP	172
Display Drive VOP	172
Display Drive LED Status	174
Display Drive Tray Status	175
Display the Drive Events Report	176
Display the Drive Media Events Report	178

## ▼ Display Drive Summary Information

Use this procedure to display summary information for all drives in the library.

If you need to perform a manual mount to a drive, this procedure displays a mapping of all addresses for each library drive:

- Firmware (internal address)
- Host software (HLI-PRC address)
- Hardware (drive bay)

The following information is also displayed:

- Access State – online, offline
- Drive State:
  - Empty
  - Unloaded – cartridge is present
  - Ready – cartridge is loaded
  - NotCommunicating
  - rewindUnload –drive is busy rewinding and unloading
- Drive Type
- Drive serial number
- Current code version
- Drive interface type

---

**Note** – This information is also available through **Reports > Drive Summary**. See [“Display a Library Report” on page 114](#) for detailed instructions.

---

1. Select Tools > System Detail, and click the Drive folder.

The screen lists the library drives and displays their locations. The internal address, drive bay, and HLI-PRC address are detailed.

The screenshot shows a software interface window titled "System Detail" with a "Drive Folder" tab selected. The window contains a table of drive data with the following columns: Internal Addr, HLI-PRC Addr, Bay, Access State, Drive State, Drive Type, Drive S/N, Code Ver, and I/F Type. Three drives are listed, all with an "online" access state and "empty" drive state. The status bar at the bottom shows "SI 3000", "Comm Status", "UserID: root", and "Librarv:crimson6.central.sun.com".

Internal Addr	HLI-PRC Addr	Bay	Access State	Drive State	Drive Type	Drive S/N	Code Ver	I/F Type
1,1,1,1,4	0,12,12,0	16	online	empty	lbrmUltrium4	1310000751	7381	Fibre
1,1,2,1,1	0,12,1,0	3	online	empty	Stk9840c	500000035000	1.35.512/4.08	Fibre
1,1,4,1,3	0,12,11,0	9	online	empty	Stk9840b	461000017722	134.355D/4.06	Fibre

## ▼ Display Drive Status

Use this procedure to display the current operational state of a drive. The information includes:

- Current drive and drive tray status information
- Whether the drive is loaded
- Cartridge VOLID if the drive is loaded
- Drive cleaning information
- Host activity

---

**Note** – This information is also available through **Reports > Drive Details**. See [“Display a Library Report”](#) on page 114 for detailed instructions.

---

1. Select **Tools > System Detail**
2. Expand the **Drive Folder**, and click the drive you want to display.
3. Click **Status**.

The screen displays the current status of the selected drive.

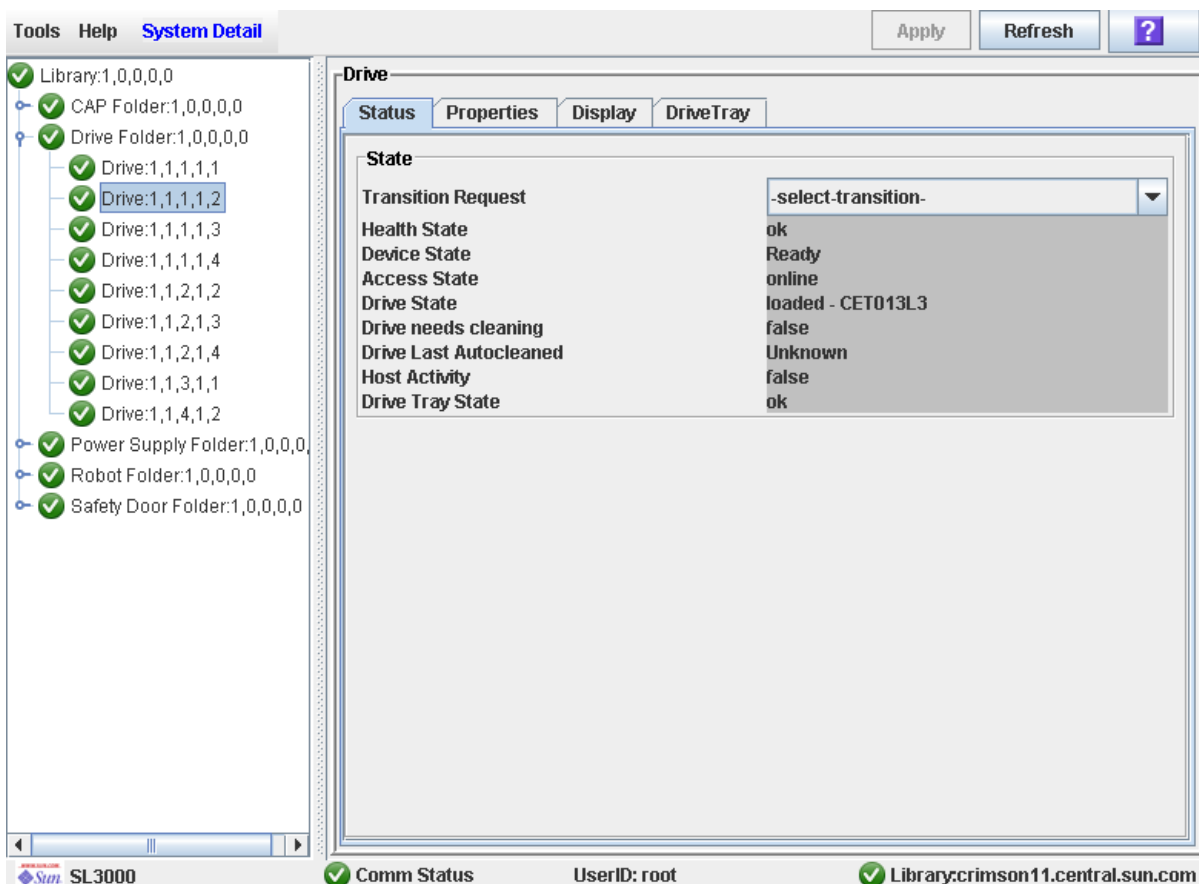

## ▼ Display Drive Properties

View detailed drive configuration information, including the drive type and serial number and port configuration.

**Note** – This information is also available through **Reports > Drive Details**. See [“Display a Library Report”](#) on page 114 for detailed instructions.

1. Select **Tools > System Detail**.
2. Expand the **Drive Folder**, and click the drive you want to display.
3. Click **Properties**.

The **Drive Properties** screen appears.

The screenshot shows the 'System Detail' window with the 'Drive' folder expanded. The 'Drive:1,1,2,1,1' is selected. The 'Properties' tab is active, showing the following information:

General	
Drive Type	Stk9840b
Code Version	134.355D/4.06
Vendor	StorageTek
Serial Number	461000001293
Interface Type	Fibre

Drive Configuration	
World Wide Name Node	50:01:04:f0:00:10:01:9e
Port A World Wide Name	50:01:04:f0:00:10:01:9f
Port A Enabled	true
Port A Loop ID	auto
Port A Speed (GB)	N/A
Port A Link status	Uninitialized
Port B World Wide Name	50:01:04:f0:00:10:01:a0
Port B Enabled	true
Port A Loop ID	auto
Port B Speed (GB)	N/A
Port B Link status	Uninitialized

The status bar at the bottom shows 'SL3000', 'Comm Status' (green checkmark), 'UserID: root', and 'Library:crimson5.storitek.com' (yellow warning icon).

## ▼ Display Drive VOP

**Note** – This procedure is for Sun StorageTek T10000 and T9840D drives only.

Use this procedure to display the Virtual Operator Panel (VOP) for T10000 and T9840D drives.

1. Select **Tools > System Detail**.
2. Expand the **Drive Folder**, and click the drive you want to display.
3. Click **Display**.

The drive VOP information appears in the Drive Virtual Op Panel section.

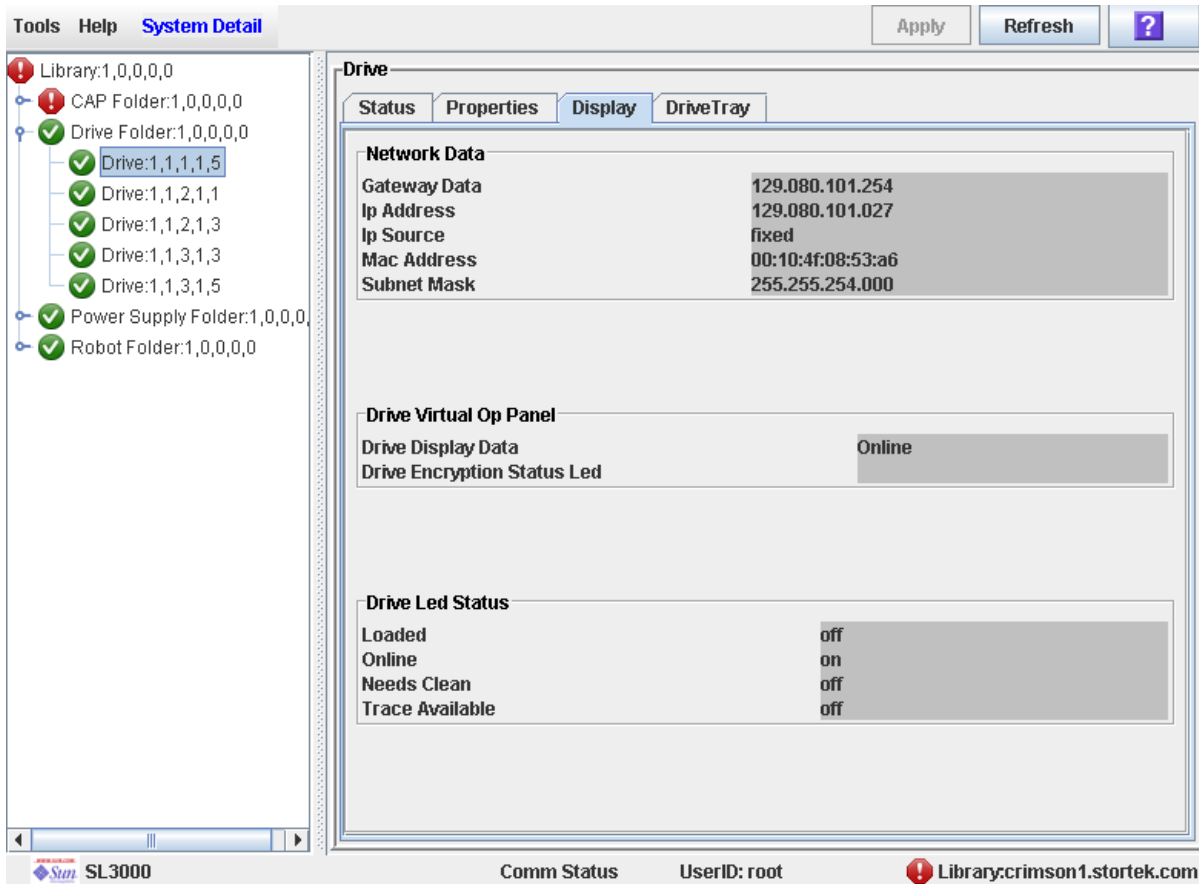



## ▼ Display Drive Network Data

Use this procedure to display IP and MAC address data for a library drive.

1. Select **Tools > System Detail**.
2. Expand the **Drive Folder**, and click the drive you want to display.
3. Click **Display**.

The data appears in the Network Data section.

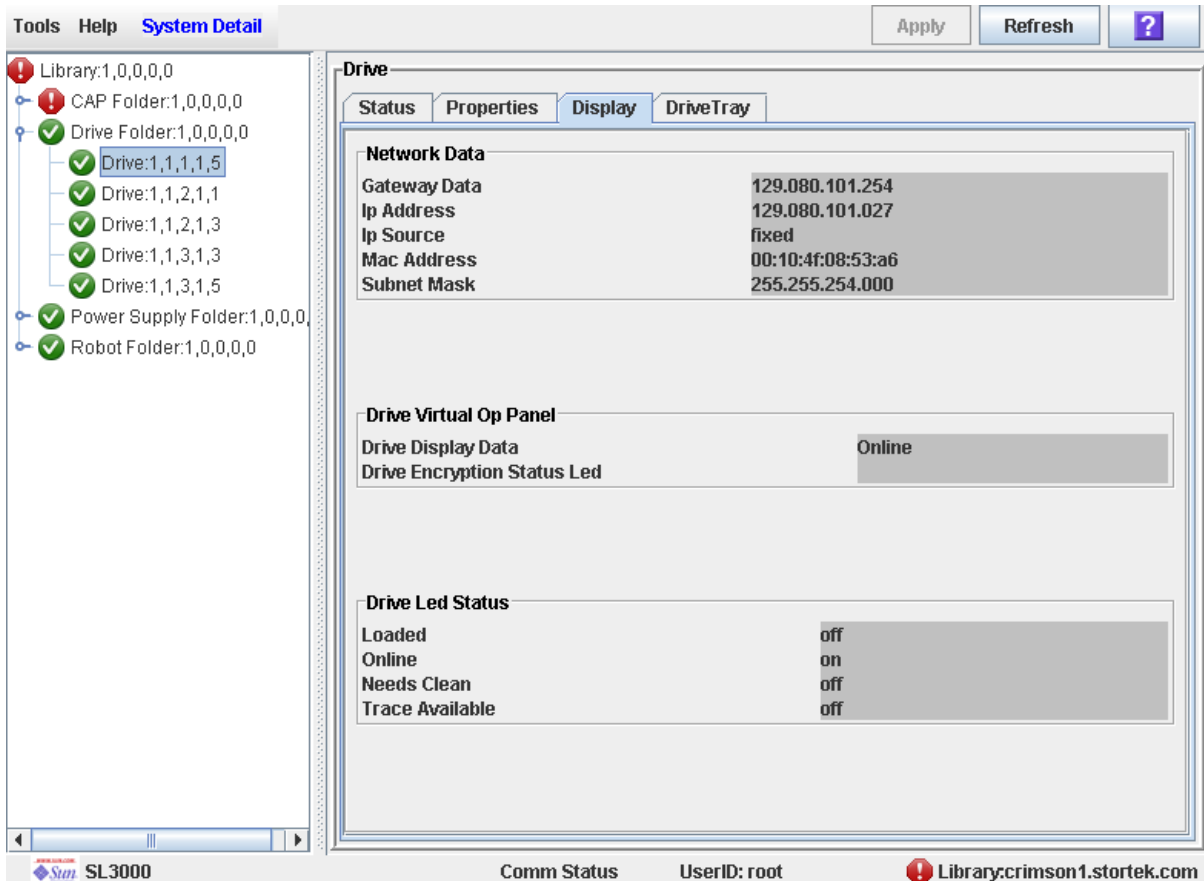

## ▼ Display Drive LED Status

Use this procedure to display current statuses of a selected drive's LEDs, including loaded, online, cleaning, and trace available statuses.

1. Select **Tools > System Detail**.
2. Expand the **Drive Folder**, and click the drive you want to display.
3. Click **Display**.

The data appears in the Drive Led Status section.

The screenshot shows the 'System Detail' window for a drive. The left-hand tree view shows a hierarchy of folders and drives, with 'Drive:1,1,1,1,5' selected. The main panel has four tabs: 'Status', 'Properties', 'Display', and 'DriveTray'. The 'Display' tab is active, showing the following data:

Network Data	
Gateway Data	129.080.101.254
Ip Address	129.080.101.027
Ip Source	fixed
Mac Address	00:10:4f:08:53:a6
Subnet Mask	255.255.254.000

Drive Virtual Op Panel	
Drive Display Data	Online
Drive Encryption Status Led	

Drive Led Status	
Loaded	off
Online	on
Needs Clean	off
Trace Available	off

The status bar at the bottom of the window displays 'SL3000', 'Comm Status', 'UserID: root', and 'Library:crimson1.stortek.com'.

## ▼ Display Drive Tray Status

Use this procedure to display the current status of a drive tray.

1. Select **Tools > System Detail**.
2. Expand the **Drive Folder**, and click the drive you want to display.
3. Click **DriveTray**.

The **Status** screen appears.

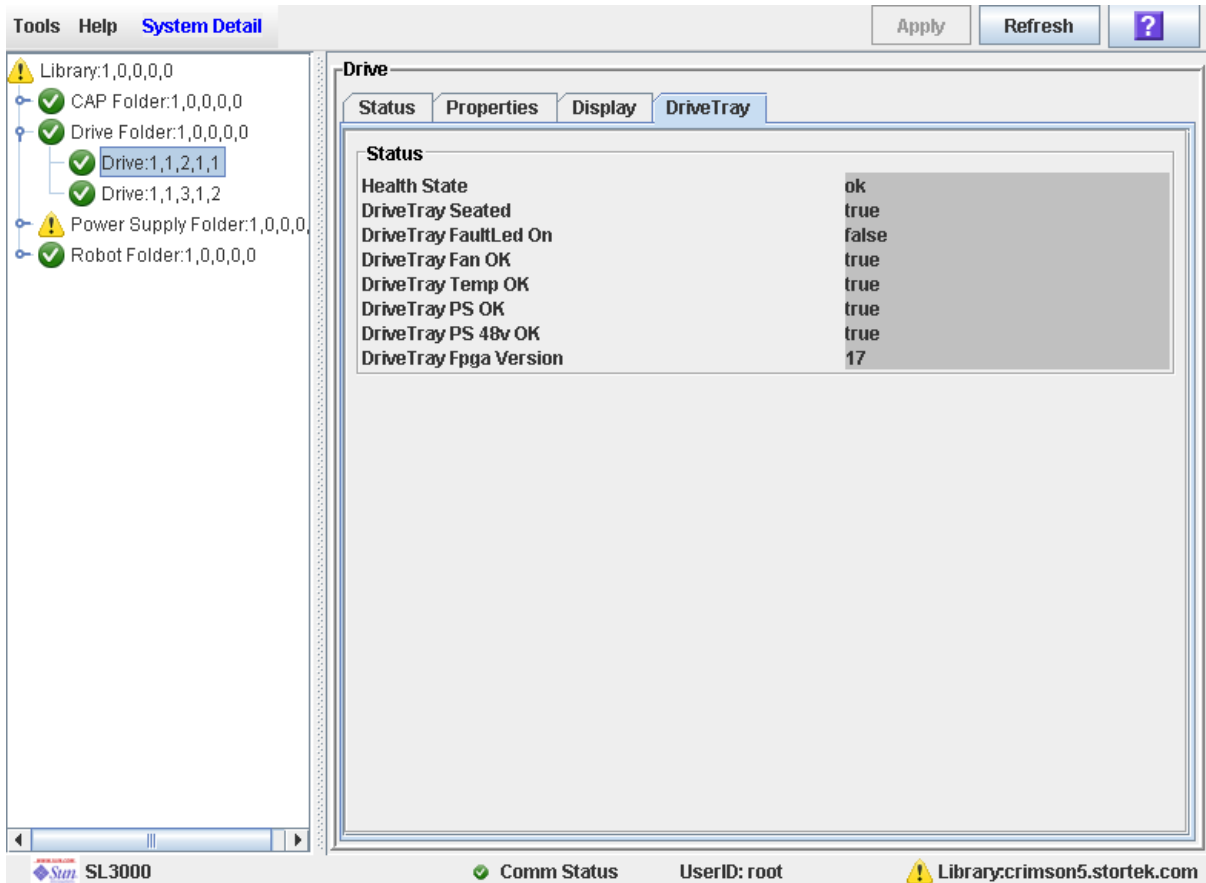

## ▼ Display the Drive Events Report

---

**Note** – This feature is available starting with SL3000 firmware version FRS\_2.30 and SL Console version FRS\_4.30.

---

The Drive Events Report summarizes drive events and errors that have occurred on library drives. The report is updated whenever there is a drive event not related to media. You can use the report to help identify and diagnose faulty drives.

For each drive that has experienced events, the report lists the type of drive, type of error, the number of occurrences, and the date and time of the last such event. The report can display up to 70 entries.

By default, the report is sorted in drive serial number order. Optionally, you can change the sort order, and rearrange and resize the columns. See [“Modifying the Screen Layout”](#) on page 36.

---

**Note** – For media errors associated with drives, see [“Display the Drive Media Events Report”](#) on page 178.

---

1. Select **Tools > Reports**.
2. Expand the **Statistics** folder, and click **Drive Events**.

Serial Number	Drive Type	Event Type	Number of Events	Last Seen
1310001961	IbmUltrium4	Drive Error	1	Sat Feb 14 10:14:5...
500000002152	Stk9840c	Load Retry	2	Tue Feb 03 18:35:...
500000002152	Stk9840c	Load Error	1	Tue Feb 03 18:35:...

SL3000    Comm Status    UserID: root    Library:crimson1.central.sun.com

## Screen Fields

### **Serial Number**

Serial number of the drive.

### **Drive Type**

Brand and model of the drive.

### **Event Type**

Type of event being tracked. All of these events indicate problems with the drive, not the media. Options are:

- Drive Error – Drive had a general problem.
- Load Error – Drive was unable to load the cartridge.
- Load Retry – Drive required retries to load the cartridge.

### **Number of Events**

Total number of events of this type that have been recorded for this drive.

### **Last Seen**

Date and time of the most recent occurrence of the error.

## ▼ Display the Drive Media Events Report

**Note** – This feature is available starting with SL3000 firmware version FRS\_2.30 and SL Console version FRS\_4.30.

The Drive Media Events Report summarizes media events that have occurred on library drives. The report is updated whenever a media event or error occurs. You can use the report to help identify and diagnose faulty drives or cartridges.

For each drive that has experienced media events, the report lists the VOLID of the cartridge, the type of event, the number of occurrences, and the date and time of the last such event. The report can display up to 500 entries.

By default, the report is sorted in drive serial number order. Optionally, you can change the sort order, and rearrange and resize the columns. See [“Modifying the Screen Layout” on page 36](#).

**Note** – For cartridge errors not necessarily associated with drives, see [“Display the Media Events Report” on page 165](#).

1. Select Tools > Reports.
2. Expand the Statistics folder, and click Drive Media Events.

Serial Numb...	Drive Type	Cartridge La...	Event Type	Number of E...	Last Seen
1210120061	IbmUltrium3	ACS168L2	Media Error	3	Sat Feb 14 10:...
1100224380	IbmUltrium2	ACS168L2	Media Error	3	Sat Feb 14 10:...
1210121073	IbmUltrium3	ACS168L2	Media Error	3	Sat Feb 14 10:...
1200019259	IbmUltrium3	ACS168L2	Media Error	3	Sat Feb 14 10:...
1210140782	IbmUltrium3	ACS168L2	Media Error	3	Sat Feb 14 10:...
1200019262	IbmUltrium3	ACS168L2	Media Error	3	Sat Feb 14 10:...
1210140761	IbmUltrium3	ACS168L2	Media Error	3	Sat Feb 14 10:...
1210140652	IbmUltrium3	ACS168L2	Media Error	3	Sat Feb 14 10:...
1210120287	IbmUltrium3	ACS168L2	Media Error	3	Sat Feb 14 10:...
1210140648	IbmUltrium3	ACS168L2	Media Error	3	Sat Feb 14 10:...
1210008915	IbmUltrium3	ACS168L2	Media Error	3	Sat Feb 14 10:...
1210120439	IbmUltrium3	ACS168L2	Media Error	3	Sat Feb 14 10:...
1210120417	IbmUltrium3	ACS168L2	Media Error	3	Sat Feb 14 10:...
1310002028	IbmUltrium4	ACS168L2	Media Error	3	Sat Feb 14 10:...
1210012341	IbmUltrium3	ACS168L2	Media Error	3	Sat Feb 14 10:...
1310002014	IbmUltrium4	ACS168L2	Media Error	3	Sat Feb 14 10:...
HU1052416A	HpUltrium3	ACS168L2	Media Error	3	Sat Feb 14 10:...
HU10546LK8	HpUltrium3	ACS168L2	Media Error	3	Sat Feb 14 10:...
1100224371	IbmUltrium2	ACS168L2	Media Error	3	Sat Feb 14 10:...
1310001961	IbmUltrium4	ACS168L2	Media Error	3	Sat Feb 14 10:...
1100224554	IbmUltrium2	ACS168L2	Media Error	3	Sat Feb 14 10:...

## Screen Fields

### **Serial Number**

Serial number of the drive.

### **Drive Type**

Brand and model of the drive.

### **Cartridge Label**

VOLID of the cartridge that has experienced an event.

### **Event Type**

Type of media event being tracked. Options are:

- Media Error – The drive indicated there was a problem with the media; this could possibly also indicate a problem with the drive.

### **Number of Events**

Total number of events of this type that have been recorded for this cartridge on this drive.

### **Last Seen**

Date and time of the most recent occurrence of the event.

---

# Drive Cleaning Tasks

---

**Note** – The drive cleaning tasks apply only to drives managed by FC-SCSI attached hosts. They do not apply to drives managed by HSC or ACSLS.

---

<b>Task</b>	<b>Page</b>
<a href="#">Configure Drive Auto Clean</a>	181
<a href="#">Enter Cleaning or Diagnostic Cartridges</a>	183
<a href="#">Eject Cleaning or Diagnostic Cartridges</a>	184
<a href="#">Display Cleaning Cartridges</a>	185
<a href="#">Display Drive Cleaning Status</a>	186
<a href="#">Clean a Drive Manually</a>	187



## ▼ Configure Drive Auto Clean

Use this procedure to enable or disable the drive auto clean feature. If the library is partitioned, auto clean can be enabled or disabled for individual partitions.

**Note** – This procedure applies only to libraries with FC-SCSI host connections; it is not applicable to libraries that have only HLI (TCP/IP) host connections.

1. Select **Tools > System Detail**, and select the library folder on the device tree.
2. Click **Auto Clean** and then **Configure**.

The **Configure Auto Clean** screen appears.

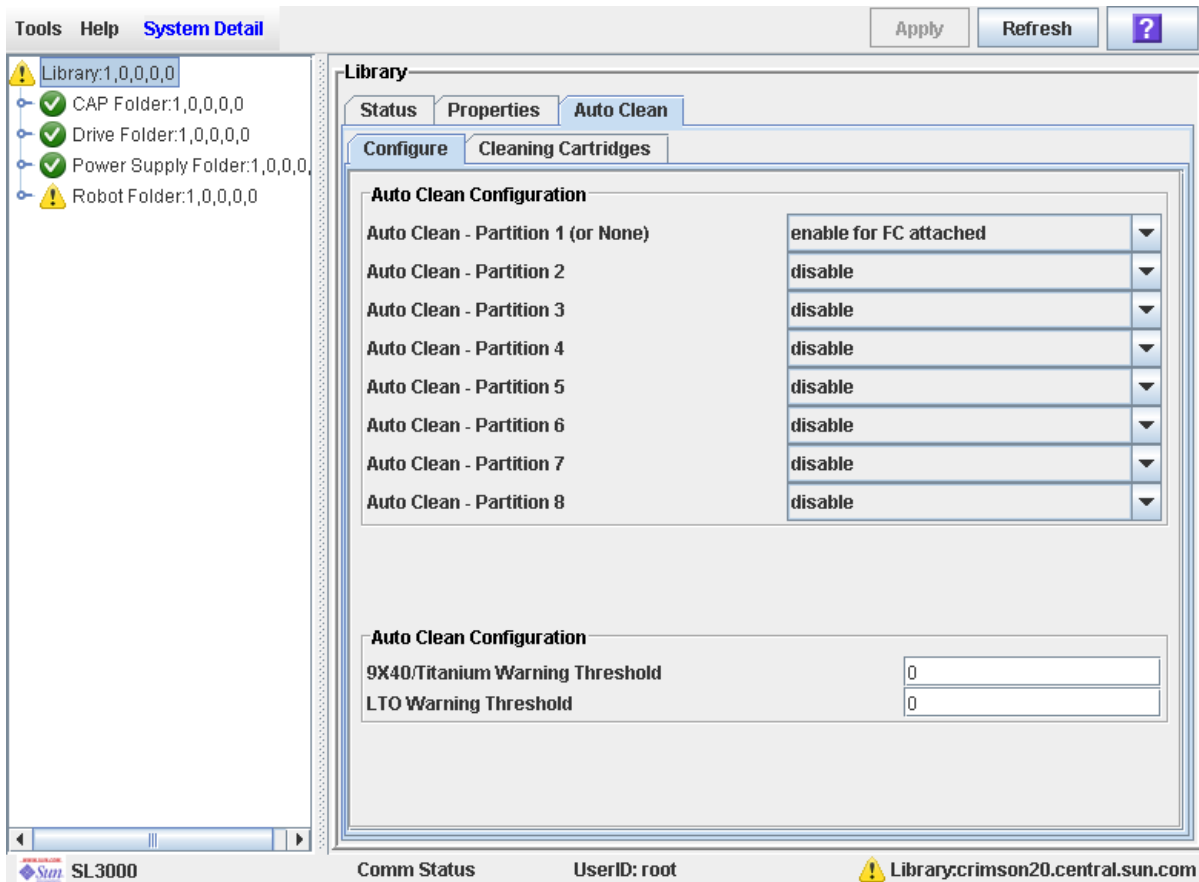

3. Complete the **Auto Clean Configuration** section as follows:

- For SL3000 partitions or whole libraries controlled by the ACSLS or HSC tape management software, automatic cleaning should always be disabled on this screen. Automatic cleaning is always managed through the ACSLS or HSC tape management software. See the ACSLS or HSC documentation for details.
- For SL3000 partitions or whole libraries controlled by FC-SCSI hosts, you can select “enable” to manage automatic cleaning through the SL Console, or you can select “disable” to manage drive cleaning manually.

- If the library is partitioned, you can use the individual pull-downs to enable or disable auto-cleaning separately for each partition. If the library is not partitioned, you only need to set the first pull-down (**Partition 1 (Or None)**); the other pull-downs will be ignored.
4. **In the Auto Clean Configuration section, specify the warning thresholds for each cartridge type.**
  5. **Click Apply.**

## ▼ Enter Cleaning or Diagnostic Cartridges

Use this procedure to manually enter cleaning or diagnostic cartridges into the library through a CAP and place the cartridges in reserved cells for storage.

---

**Note** – This procedure applies only to libraries with FC-SCSI host connections; it is not applicable to libraries that have only HLI (TCP/IP) host connections.

---



---

**Note** – If you are entering cartridges into an FC-SCSI partition that has one or more shared rotational or AEM CAPs and the host application does not use CAP reservations and prevent/allow commands, you must associate the partition to its CAPs before beginning this procedure. See [“Associate an FC-SCSI Partition to Its Shared CAPs”](#) for details. Failure to do this may cause the CAP to remain locked and may prevent the partition from acquiring ownership of the CAP.

---

1. **Verify that the following conditions are true:**
  - The required number of system reserved cells are empty. The Base and DEM modules each must always have at least one open system cell for TallBot recovery or library initialization.
  - All library CAPs are in the following condition:
    - Available – that is, not reserved by any host,
    - Empty, and
    - Closed and locked.
2. **Quiesce the library to all hosts. See the appropriate tape management software documentation for the procedures and commands.**
3. **Set the library CAP assignment mode to “diagnostic”.** For detailed instructions, see [“Change the CAP Assignment Mode for an FC-SCSI Library”](#) on page 138.
4. **Manually unlock the CAP door.** For detailed instructions, see [“Unlock a CAP or AEM Access Door”](#) on page 134.
5. **Load the cleaning or diagnostic cartridges in the CAP, and close the CAP.** For detailed instructions, see [“Enter Cartridges Through a Rotational CAP”](#) on page 141 or [“Bulk Load Cartridges Through an AEM CAP”](#) on page 143.  
The CAP closes and locks automatically, and the CAP button light turns off. The TallBot audits the CAP.
6. **Manually move each cartridge to a reserved cell.** For detailed instructions, see [“Move a Cartridge From a Specified Location”](#) on page 163.  
When all cartridges have been moved from the CAP, the library recognizes that the CAP is empty and the CAP remains locked.
7. **Return the CAP assignment mode to “host operations” to enable normal cartridge mount/dismount operations.** For detailed instructions, see [“Change the CAP Assignment Mode for an FC-SCSI Library”](#) on page 138.
8. **Make the library available to all hosts.** See the appropriate tape management software documentation for the procedures and commands.

## ▼ Eject Cleaning or Diagnostic Cartridges

Use this procedure to move expired cleaning or diagnostic cartridges from reserved cells to the CAPs and manually eject the cartridges from the library.

---

**Note** – This procedure applies only to libraries with FC-SCSI host connections; it is not applicable to libraries that have only HLI (TCP/IP) host connections.

---



---

**Note** – If you are entering cartridges into an FC-SCSI partition that has one or more shared rotational or AEM CAPs and the host application does not use CAP reservations and prevent/allow commands, you must associate the partition to its CAPs before beginning this procedure. See [“Associate an FC-SCSI Partition to Its Shared CAPs”](#) for details. Failure to do this may cause the CAP to remain locked and may prevent the partition from acquiring ownership of the CAP.

---

1. **Verify that all library CAPs are in the following condition:**
  - Available – that is, not reserved by any host,
  - Empty, and
  - Closed and locked.
2. **Display all cleaning cartridges in the library and note their locations.** See [“Display Cleaning Cartridges”](#) on page 185 for detailed instructions. You will use the library internal addresses when you move each cartridge to the CAP in Step 5.
3. **Quiesce the library to all hosts.** See the appropriate tape management software documentation for the procedures and commands.
4. **Set the CAP assignment mode to “diagnostic”.** For detailed instructions, see [“Change the CAP Assignment Mode for an FC-SCSI Library”](#) on page 138.
5. **Manually move each cleaning cartridge from a reserved cell to the CAP.** For detailed instructions, see [“Move a Specified Cartridge by VOLID”](#) on page 161.
6. **Remove all cartridges from the CAP, and close the CAP.** For detailed instructions, see [“Eject Cartridges Through a Rotational CAP”](#) on page 142 or [“Bulk Unload Cartridges Through an AEM CAP”](#) on page 145.
 

The CAP closes and locks automatically, and the CAP button light turns off. The TallBot audits the CAP.

The library recognizes that the CAP is empty and the CAP remains locked.
7. **Return the CAP assignment mode to “host operations” to enable normal cartridge mount/dismount operations.** For detailed instructions, see [“Change the CAP Assignment Mode for an FC-SCSI Library”](#) on page 138.
8. **Make the library available to all hosts.** See the appropriate tape management software documentation for the procedures and commands.

## ▼ Display Cleaning Cartridges

1. Select **Tools > System Detail**, and select the library folder on the device tree.
2. Click **Auto Clean** and then **Cleaning Cartridges**.

The Library Cleaning Cartridges screen appears.

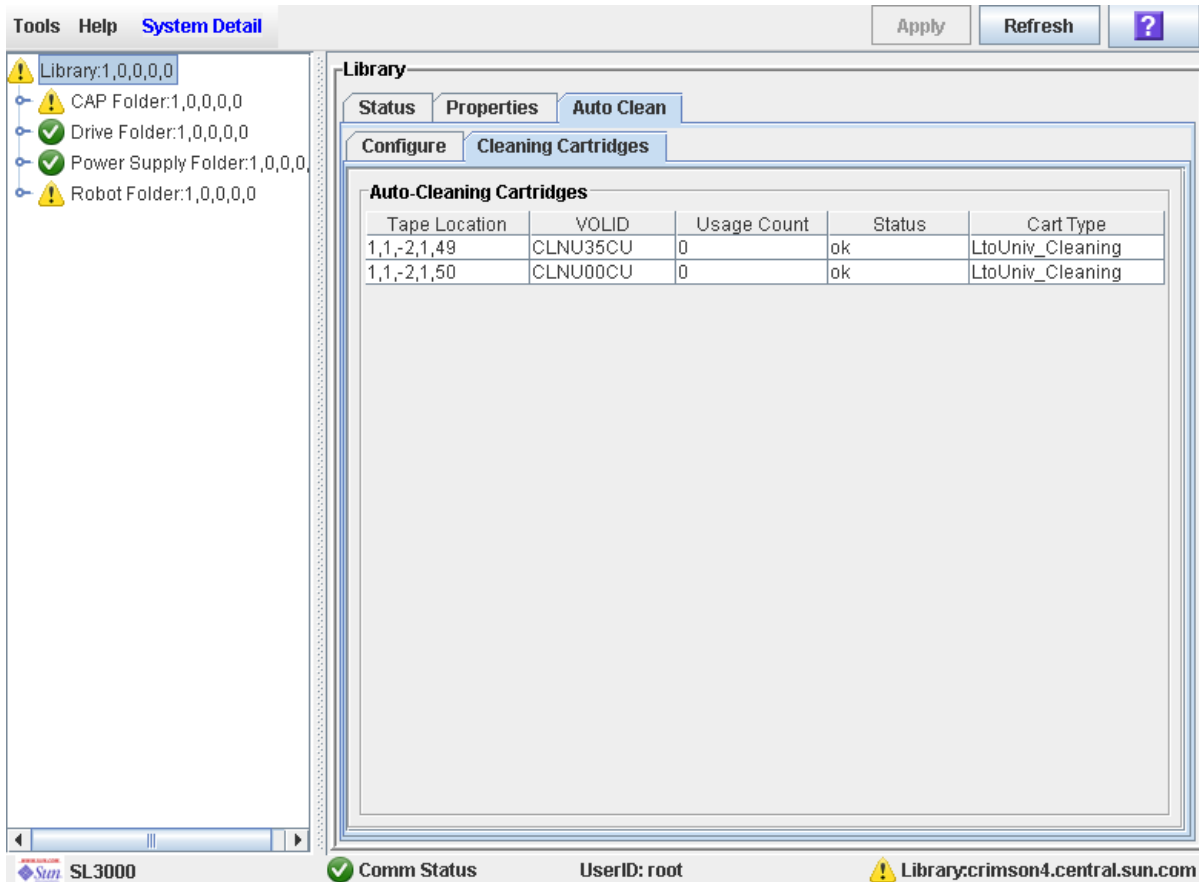

The list displays the following details for each cleaning cartridge:

- Cartridge location (reserved cells)
- VOLID
- Usage Count
- Status (OK, warning, expired)
- Cartridge Type (for example, LTO, SDLT)

## ▼ Display Drive Cleaning Status

**Note** – This procedure applies only to libraries with FC-SCSI host connections; it is not applicable to libraries that have only HLI (TCP/IP) host connections.

Use this procedure to display the current cleaning status of a drive.

1. Select **Tools > System Detail**.
2. Expand the **Drive Folder**, and select the drive you want to display.
3. Click **Status**.

The screen displays the following cleaning details:

- Drive needs cleaning
- Drive Last Cleaned or Drive Last Autocleaned

**Note** – You can schedule manual drive cleaning by monitoring the “Drive needs cleaning” status.

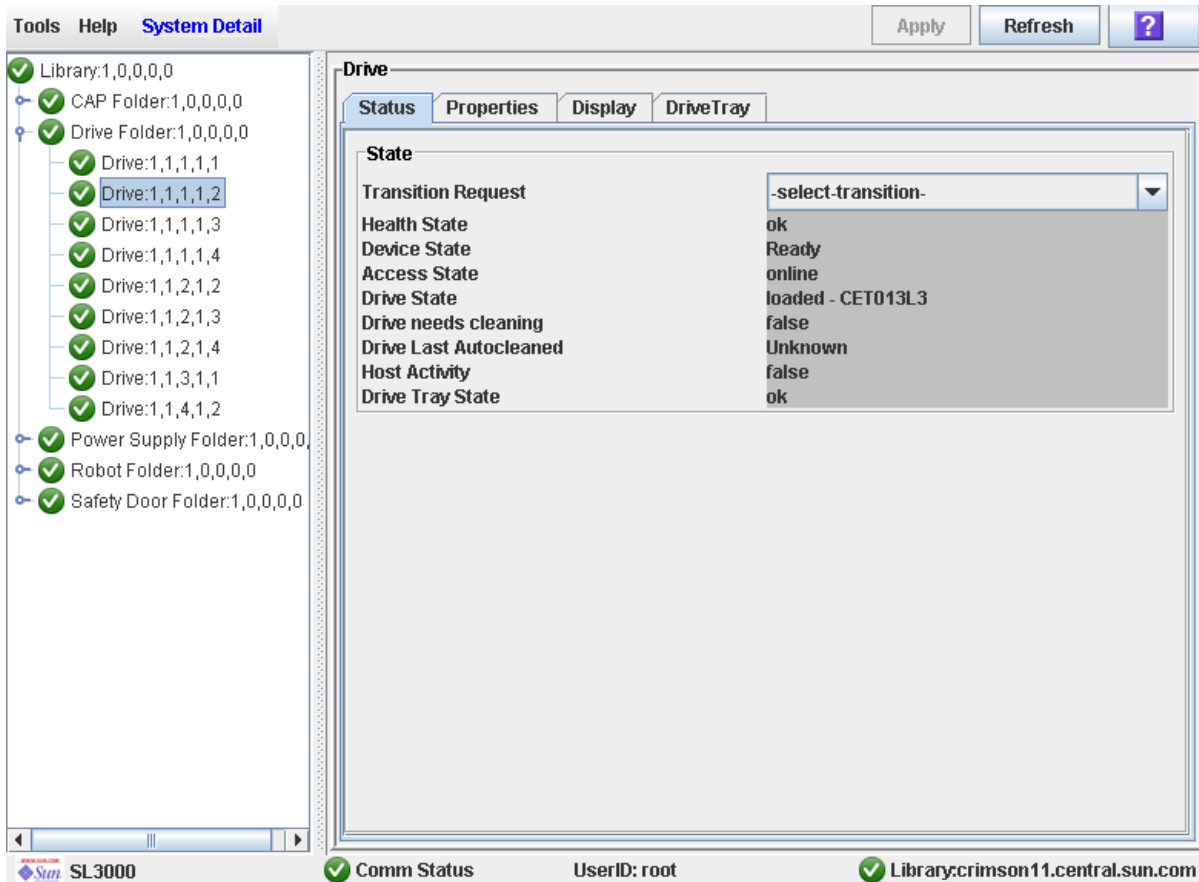

## ▼ Clean a Drive Manually

---

**Note** – This procedure applies only to libraries with FC-SCSI host connections; it is not applicable to libraries that have only HLI (TCP/IP) host connections.

---

Use this procedure to clean a drive. The SL3000 does not offer a dedicated manual drive cleaning function. Essentially, you must perform a manual mount of a cleaning cartridge on the drive.

You can initiate a manual clean at any time, even if the drive is not due for cleaning.

1. **Display a list of cleaning cartridges.** See [“Display Cleaning Cartridges” on page 185](#) for detailed instructions.

Your library could contain more than one type of drive. So verify that the reserved cells have the appropriate cleaning cartridges for the drive being cleaned.

2. **Manually move a cleaning cartridge from a reserved cell to the drive that needs cleaning.** See [“Move a Cartridge From a Specified Location” on page 163](#) for detailed instructions.
3. **Display the status of the cleaning operation on the Drive Clean Status Console.** See [“Display Drive Cleaning Status” on page 186](#) for detailed instructions.
4. **When the cleaning operation is complete, move the cleaning cartridge from the drive back to a reserved cell.** See [“Move a Cartridge From a Specified Location” on page 163](#) for detailed instructions.

---

# Robot and Power Supply Tasks

<b>Task</b>	<b>Page</b>
<a href="#">Configure SCSI FastLoad in a Non-Partitioned Library</a>	189
<a href="#">Configure SCSI FastLoad for a Partition</a>	191
<a href="#">Display Robot Summary Information</a>	193
<a href="#">Display Robot Status</a>	194
<a href="#">Display Robot Properties</a>	195
<a href="#">Display Power Supply Summary Information</a>	196
<a href="#">Display Power Supply Detail</a>	197
<a href="#">Display Power Supply Summary Information</a>	196
<a href="#">Display Power Supply Detail</a>	197



## ▼ Configure SCSI FastLoad in a Non-Partitioned Library

---

**Note** – This feature is available starting with SL3000 firmware version FRS\_2.33 and SL Console version FRS\_4.47.

---

Use this procedure to configure the SCSI FastLoad feature for an FC-SCSI library. For details on this feature, see [“SCSI FastLoad Feature” on page 94](#).

---

**Note** – This procedure applies only to libraries with FC-SCSI host connections; it is not applicable to libraries that have only HLI (TCP/IP) host connections.

---



---

**Note** – This procedure is used for non-partitioned libraries only. For partitioned libraries, see [“Configure SCSI FastLoad for a Partition” on page 191](#).

---

### 1. Select Tools > Configuration.

The **Library Configuration** screen appears.

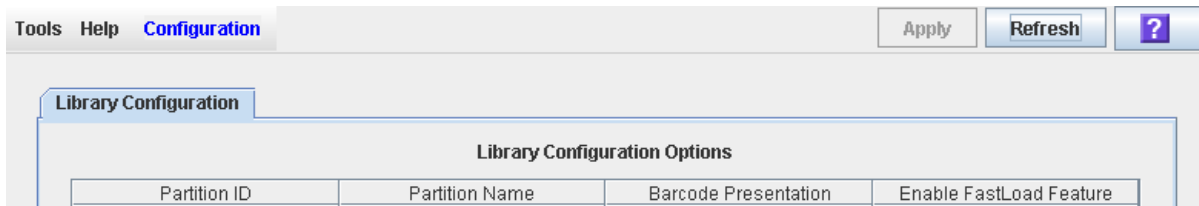

### 2. Use the Enable FastLoad Feature checkbox to indicate whether you want to enable the FastLoad feature for the entire library.

---

**Note** – The Partition Name “scsi0” indicates a non-partitioned library.

---

Checkbox settings are as follows:

- Checked – Turns SCSI FastLoad on. A cartridge mount is considered complete as soon as the drive indicates that it has accepted the cartridge.

- Unchecked – Turns SCSI FastLoad off. A cartridge mount is considered complete only after the cartridge has been loaded and threaded in the drive and the drive indicates that it is ready for read/write operations. This is the default setting.

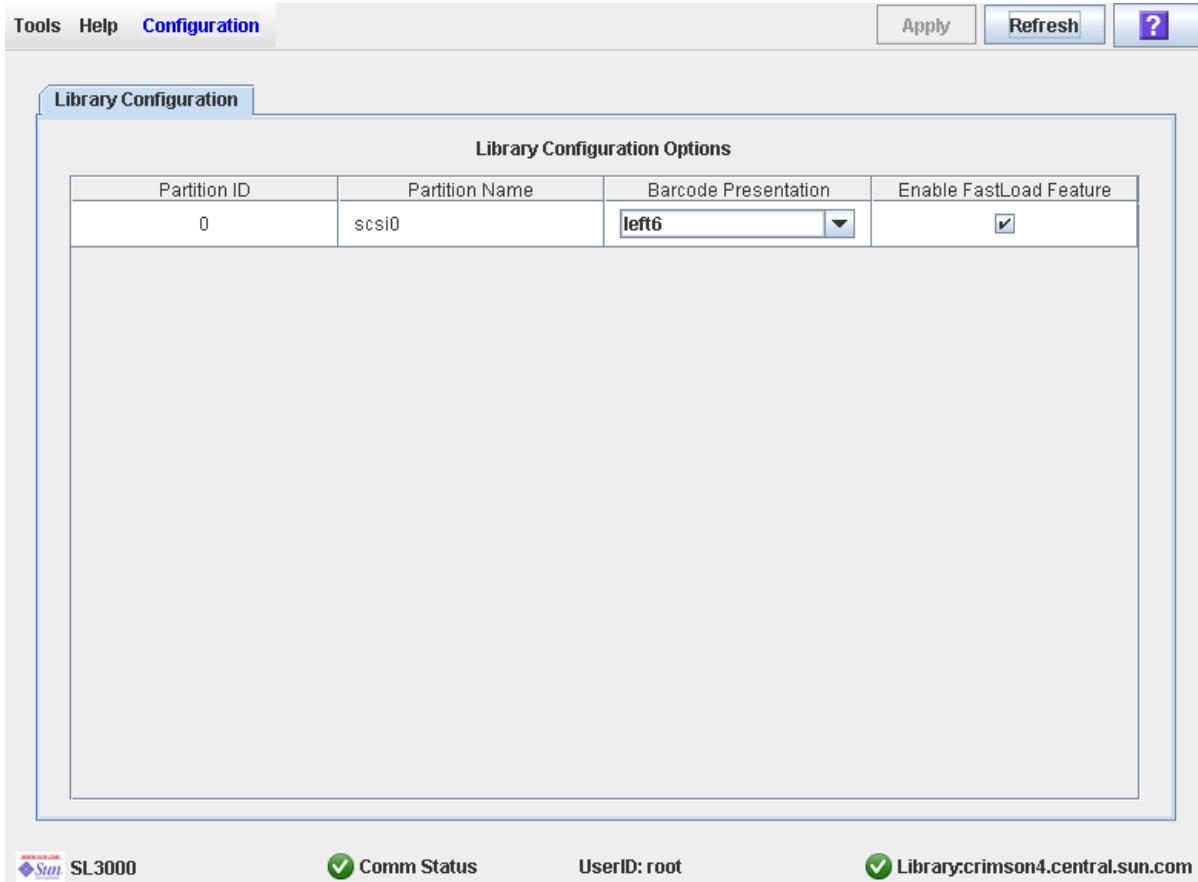

**3. Click Apply.**

A confirmation popup appears. The new SCSI FastLoad feature setting is effective immediately; the library does not need to be rebooted.

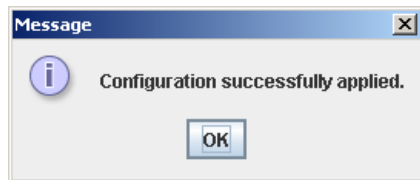

**4. Click OK to dismiss the popup.**

## ▼ Configure SCSI FastLoad for a Partition

---

**Note** – This feature is available starting with SL3000 firmware version FRS\_2.33 and SL Console version FRS\_4.47.

---

Use this procedure to configure the SCSI FastLoad feature for an FC-SCSI library. For details on this feature, see [“SCSI FastLoad Feature” on page 94](#).

You can enable or disable SCSI FastLoad separately for each partition.

---

**Note** – This procedure applies only to libraries with FC-SCSI host connections; it is not applicable to libraries that have only HLI (TCP/IP) host connections.

---



---

**Note** – This procedure is used for partitioned libraries. For non-partitioned libraries, see [“Configure SCSI FastLoad in a Non-Partitioned Library” on page 189](#).

---

### 1. Select Tools > Configuration.

The **Library Configuration** screen appears.

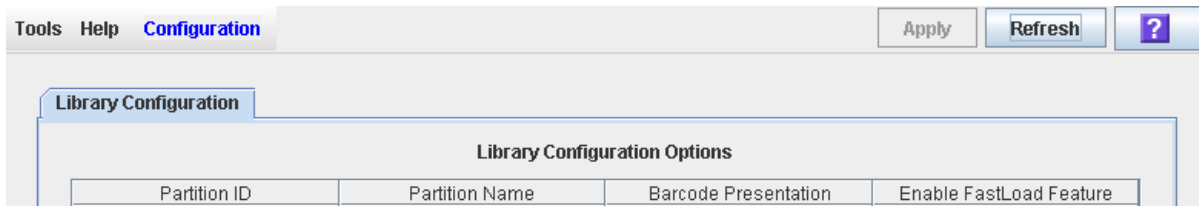

### 2. Use the Enable FastLoad Feature checkbox for each partition to indicate whether you want to enable the FastLoad feature. You can use multiple checkboxes to indicate settings for more than one partition at a time.

Checkbox settings are:

- Checked – Turns SCSI FastLoad on. A cartridge mount is considered complete as soon as the drive indicates that it has accepted the cartridge.

- Unchecked – Turns SCSI FastLoad off. A cartridge mount is considered complete only after the cartridge has been loaded and threaded in the drive and the drive indicates that it is ready for read/write operations. This is the default setting.

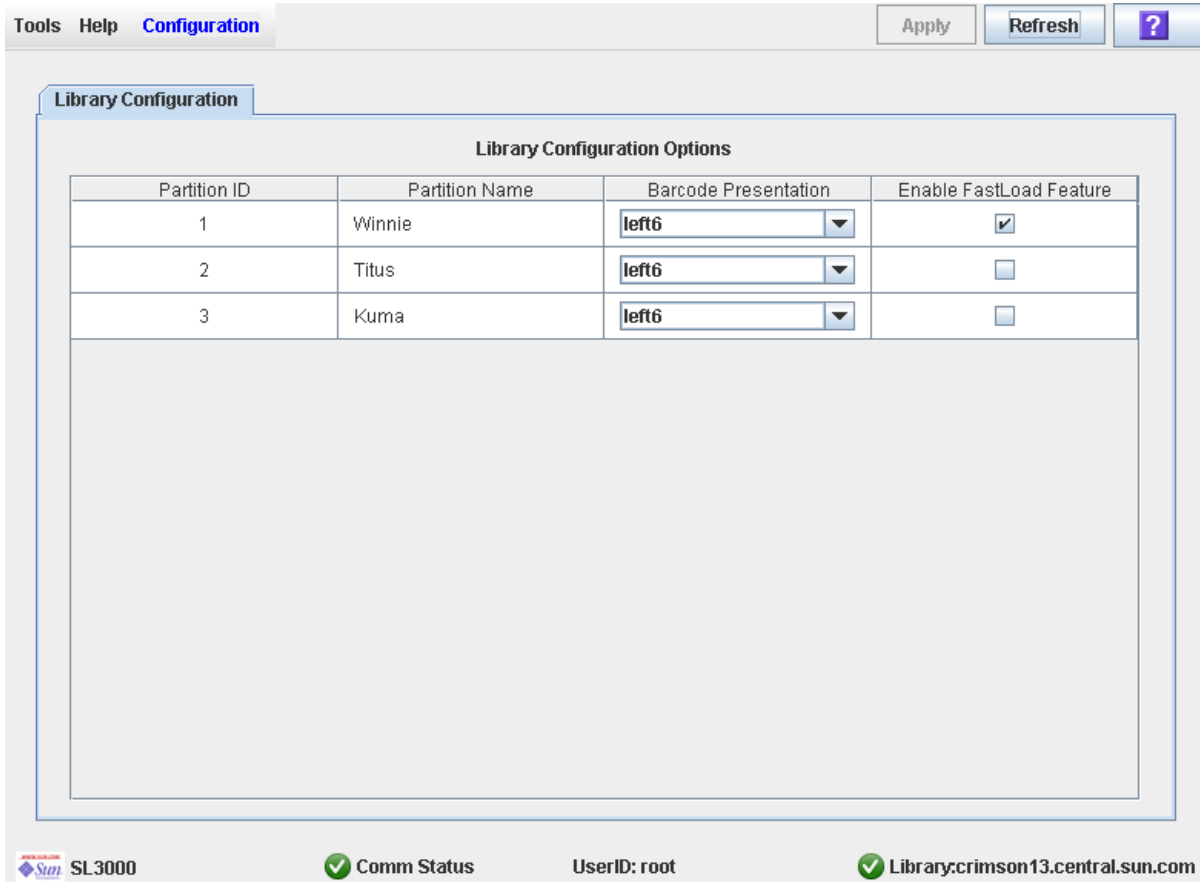

3. Click **Apply**.

A confirmation popup appears. The new SCSI FastLoad settings are effective immediately; the library does not need to be rebooted.

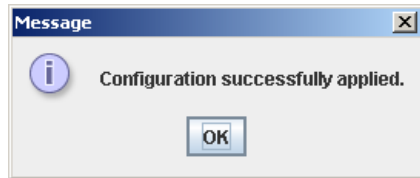

4. Click **OK** to dismiss the popup.

## ▼ Display Robot Summary Information

Use this procedure to display summary information for the library TallBots.

---

**Note** – This information is also available through **Reports > Robot Summary**. See [“Display a Library Report”](#) on page 114 for detailed instructions.

---

1. Select **Tools > System Detail**.
2. Click the **Robot** folder on the device tree.

The **Robot Data** screen appears.

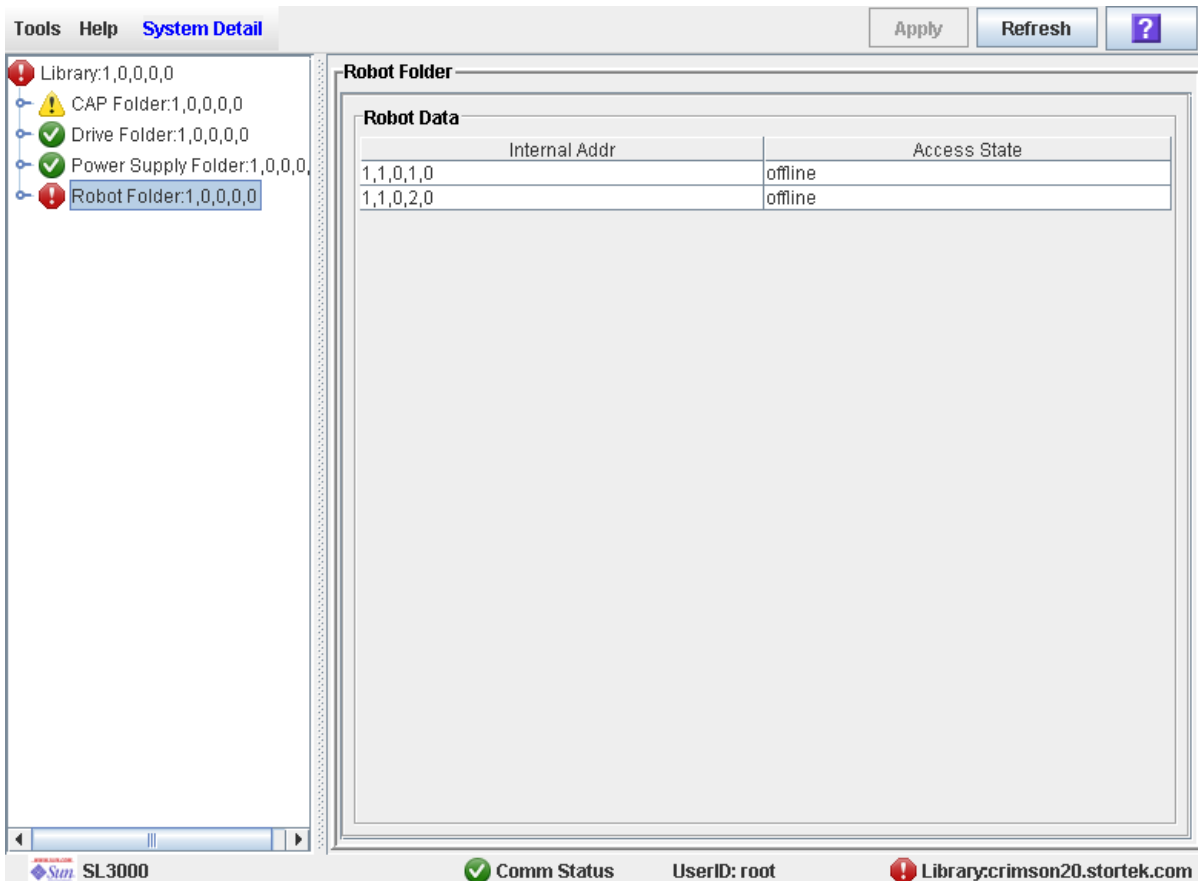

## ▼ Display Robot Status

Use this procedure to display the current operational state of a TallBot.

---

**Note** – This information is also available through **Reports > Robot Details**. See [“Display a Library Report”](#) on page 114 for detailed instructions.

---

1. Select **Tools > System Detail**.
2. Expand the **Robot Folder**, and click the robot you want to display.
3. Click **Status**.

The screen displays the current status of the selected TallBot.

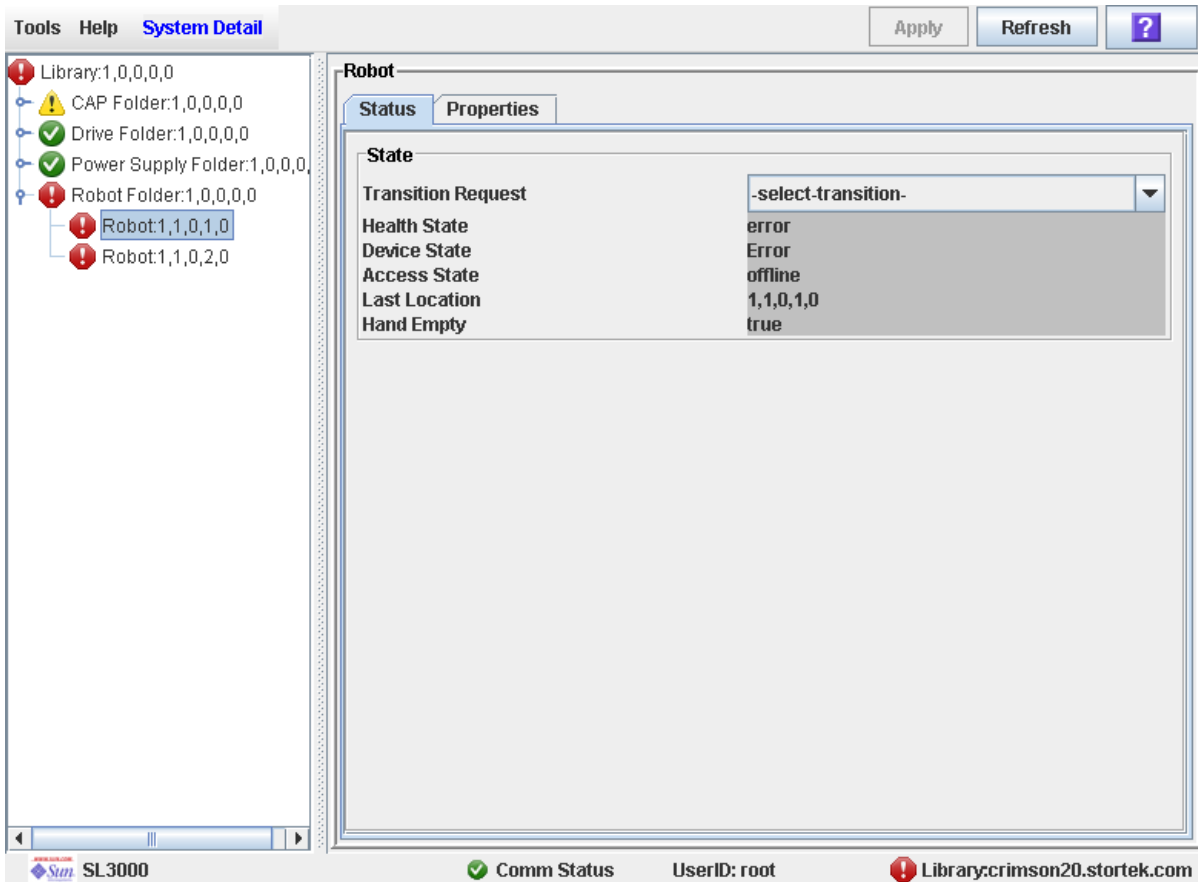

## ▼ Display Robot Properties

View detailed TallBot configuration information, including the serial number and current firmware levels.

---

**Note** – This information is also available through **Reports > Robot Details**. See [“Display a Library Report” on page 114](#) for detailed instructions.

---

1. Select **Tools > System Detail**.
2. Expand the **Robot Folder**, and click the robot you want to display.
3. Click **Properties**.

The **Robot Properties** screen appears.

The screenshot displays the 'System Detail' window for a robot. The left-hand tree view shows the following structure:

- Library:1,0,0,0,0 (Warning icon)
- CAP Folder:1,0,0,0,0 (Warning icon)
- Drive Folder:1,0,0,0,0 (Success icon)
- Power Supply Folder:1,0,0,0,0 (Success icon)
- Robot Folder:1,0,0,0,0 (Warning icon)
  - Robot:1,1,0,1,0 (Warning icon, selected)
  - Robot:1,1,0,2,0 (Warning icon)

The main content area is titled 'Robot' and has two tabs: 'Status' and 'Properties'. The 'Properties' tab is active, showing:

**Robot Properties**

FRU Serial Number: HBB 74004957

**Code Version**

Name	Executing Version	Flash Version
disk.hbb.plmage	4.50.33	4.50.33
kernel.plmage	4.48.72	4.48.72
libs.cramfs	4.49.10	4.49.10
robot.cramfs	4.50.69	4.50.69
u-boot.bin	1.00.05	1.00.05

The status bar at the bottom of the window shows:

- SL3000
- Comm Status: ✔
- UserID: root
- Library:crimson20.stortek.com ! (Warning icon)

## ▼ Display Power Supply Summary Information

The Power Supply Data screen displays summary information for all power supplies in the library. You can use this screen to monitor the status of the power supplies.

By default, the display is sorted by power supply internal address. Optionally, you can change the sort order, and rearrange and resize the columns. See [“Modifying the Screen Layout”](#) on page 36.

1. Select Tools > System Detail.
2. On the Library tree, click the Power Supply Folder.
3. The Power Supply Data screen is displayed.

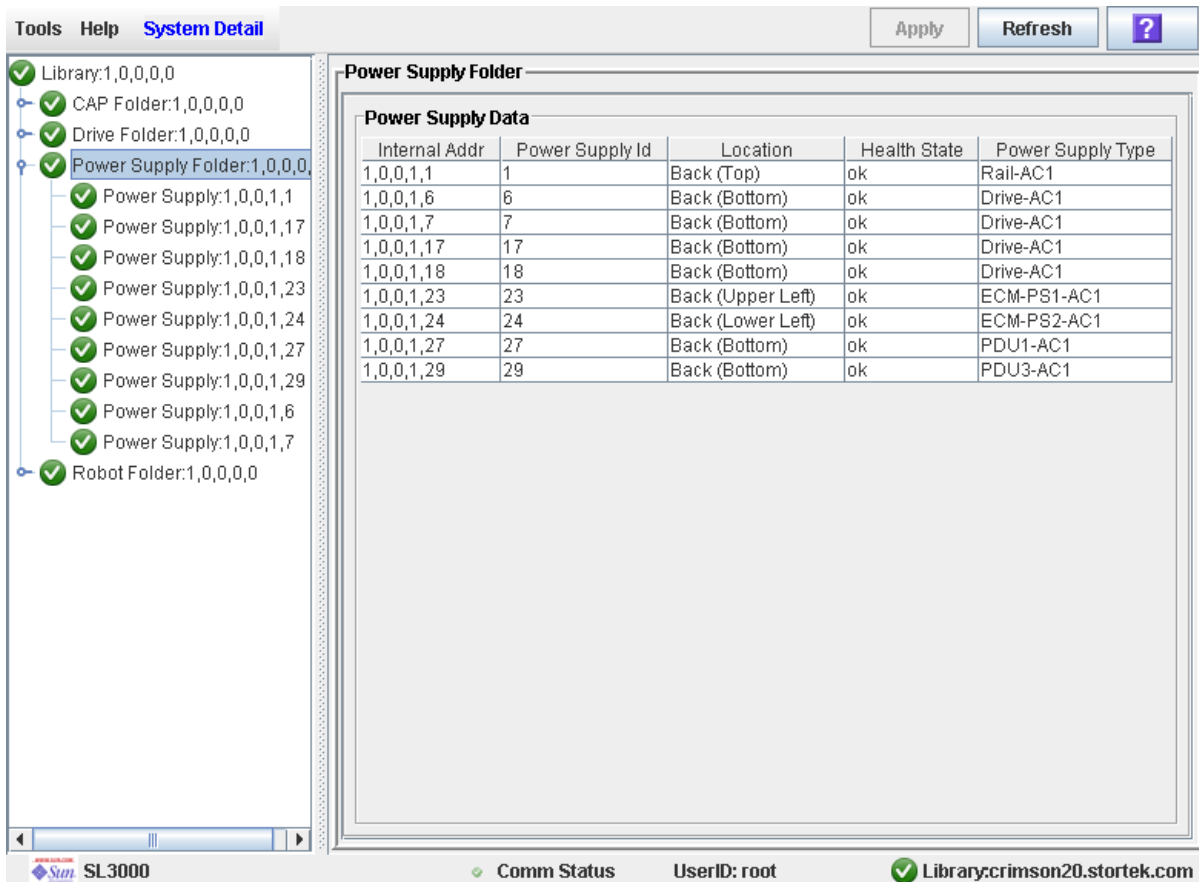



## ▼ Display Power Supply Detail

The Power Supply Status screen displays detailed information for a selected power supply. You can use this screen to determine whether the power supply is in need of maintenance or replacement.

1. Select **Tools > System Detail**.
2. On the **Library tree**, expand the **Power Supply Folder**.
3. Click the power supply you want to display.
4. The **Power Supply Status** screen is displayed.

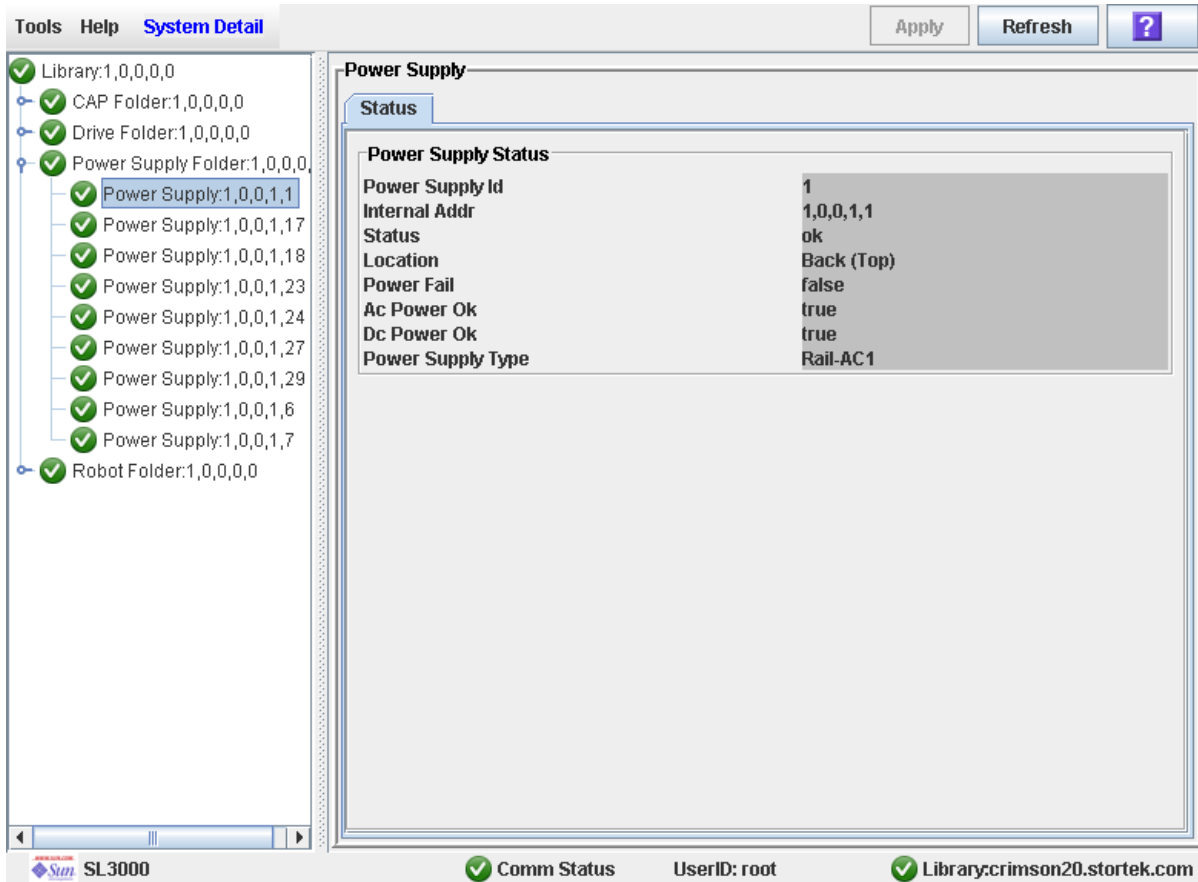

---

# AEM Safety Door Management Tasks

<b>Task</b>	<b>Page</b>
<a href="#">Display AEM Safety Door Status</a>	<a href="#">199</a>
<a href="#">Display AEM Safety Door Properties</a>	<a href="#">200</a>

## ▼ Display AEM Safety Door Status

Use this procedure to display the current state of an AEM safety door. The safety door is the internal “garage” door, which lowers to separate the AEM from the rest of the library.

---

**Note** – Status information on the AEM access door, which is the door you open to bulk load or unload cartridges to or from the library, is displayed on the **CAP Status** screen. See [“Display Current Rotational or AEM CAP Status” on page 128](#) for detailed instructions.

---

1. Select **Tools > System Detail**.
2. Expand the **Safety Door Folder**, and click the safety door you want to display.
3. Click **Status**.

The **Safety Door Status** screen appears.

“Door open” indicates that the safety door is up and the TallBot is free to move in and out of the AEM. “Door closed” indicates that the safety door is down and it is safe for you to open the AEM access door.

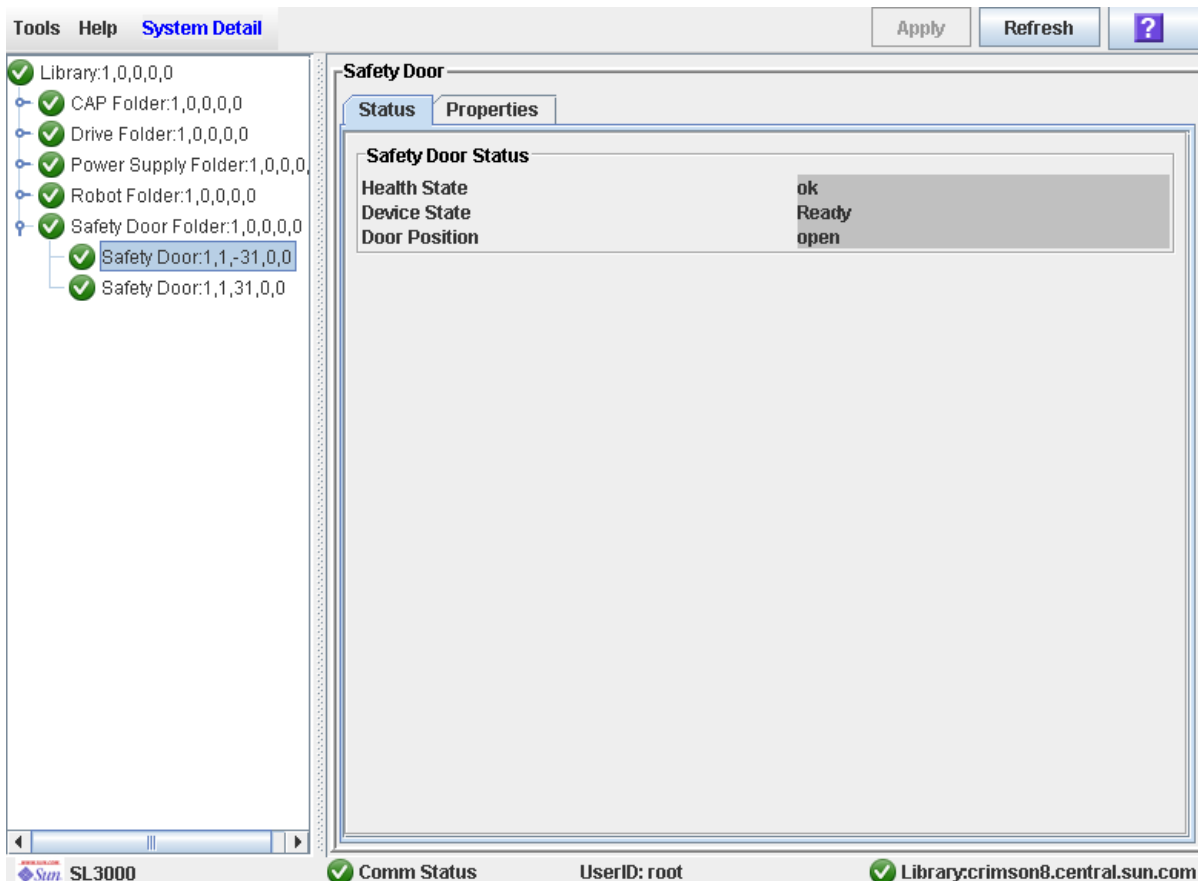

## ▼ Display AEM Safety Door Properties

Use this procedure to display detailed information for an AEM safety door, including the serial number and current firmware versions. The safety door is the internal “garage” door that lowers in preparation for you to open the AEM access door.

---

**Note** – This information is also available through the **CAP Properties** screen and the **CAP Details** report. See [“Display Rotational or AEM CAP Properties”](#) on page 131 and [“Display a Library Report”](#) on page 114 for detailed instructions.

---

1. Select **Tools > System Detail**.
2. Expand the **Safety Door Folder**, and click the safety door you want to display.
3. Click **Properties**.

The **Safety Door Properties** screen appears.

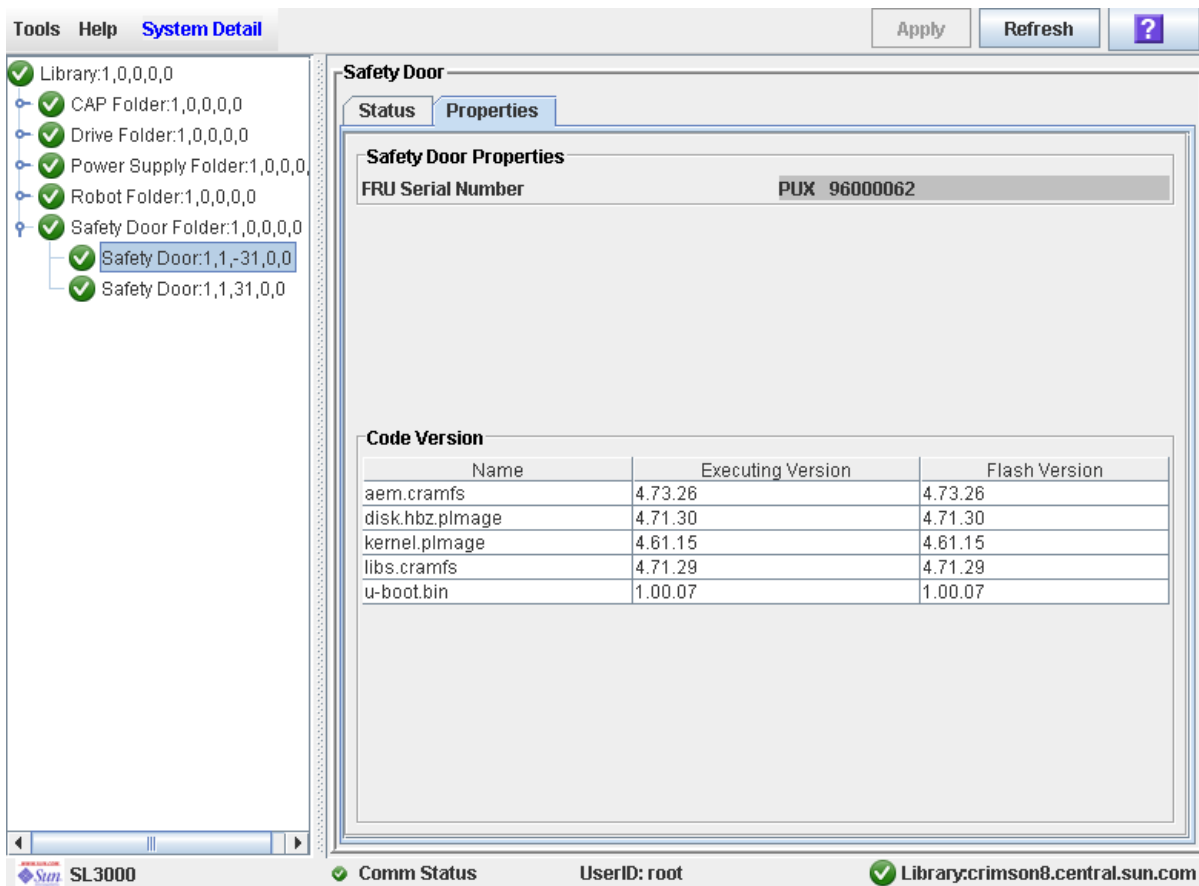

## Licensing

---

The licensing utility allows you to install selected optional features on the SL3000 library.

---

**Note** – The functions described in this chapter can be performed from the standalone SL Console or Web-launched SL Console only; these functions are not available at the local operator panel.

---

---

## License Key File

A license key file can be delivered to you in the following ways:

- Via e-mail from Sun Microsystems, Inc.
- Installed by your Sun support representative

The license key file is a digitally signed Java Archive (.jar) file containing one or more license keys for features you have purchased. In order to ensure that features are installed on the correct library, the license key file includes the serial number of the target library and can only be installed on that library.

All licensed SL3000 features you have purchased for a library are included in a single license key file.

---

**Caution** – When you install a new license key file, it overlays any previously installed license on the library. Therefore, it is essential that you verify the contents of a new license key file before installing it, in order to ensure that it contains all features you have purchased over the life of the library. If it does not contain all the features you have purchased, when you install the new file you could potentially remove features that have previously been installed on the library. If a license key file is inaccurate in any way, you should request a new one from your Sun support representative.

---

---

# License Expirations

---

**Note** – Most SL3000 licenses do not expire. The only license that expires is “Service.”

---

For licenses that expire, it is important to manage the expirations in order to prevent unintended loss of library features and function.

You can use the [License Management > Current License](#) screen to display the expiration dates and time remaining.

In addition, when a license is close to expiring, the library controller sends messages to the SL Console Event Log. For example, if a Service license is due to expire within 30 days, an information message is sent every 12 hrs, and if the Service license has less than 10 days remaining, a warning message is sent every 12 hours. You can use either of the following methods to view these messages:

- Through the **Tools > Reports** menu option. See “[Library Reports](#)” on page 77 for details.
- Through the **Status Module** screen. See “[Status Alert Messages](#)” on page 78 for details.

---

# Licensing Tasks

This section provides detailed instructions for all tasks involved in installing and managing library feature licenses.

## License Installation Process

Following is a summary of the license installation process. Optionally, you can choose to have this process done by your Sun support representative.

1. You purchase one or more features for a specific Sun StorageTek library from Sun Microsystems, Inc.
2. Sun sends you an e-mail with an attached license key file.
3. You download the license key file to a system accessible to the SL Console session.
4. You use the SL Console to display and verify the contents of the license key file.
5. You use the SL Console to install the license key file on the target library.
6. See the following topics for detailed information about implementing specific licensed features:
  - [“Capacity on Demand” on page 223](#)
  - [“Library Partitioning” on page 267](#)

## Licensing Task Summary

---

**Note** – You can perform these tasks from the standalone SL Console or Web-launched SL Console only. They are not available at the local operator panel.

---

<b>Task</b>	<b>Page</b>
<a href="#">Receive a New License Key File</a>	205
<a href="#">Display and Verify New License Contents</a>	206
<a href="#">Install a New License on the Target Library</a>	209
<a href="#">Display Current Library License</a>	212



## ▼ Receive a New License Key File

Use this procedure to receive a license key file, which licenses features for a specific Sun StorageTek library.

---

**Note** – This procedure is not performed at the SL Console.

---

**1. Purchase one or more features from Sun Microsystems, Inc.**

See your Sun support representative for assistance.

**2. Receive the license key file from Sun, via e-mail.**

Following is a sample of the e-mail header:

```
Subject:      SL3000 License Key CR6636975
Date:        Wed, 05 Dec 2007 19:24:41 -0700 (MST)
From:        siks-devoffshore@sun.com
```

**3. Download the license key file to a system accessible to the SL Console session.**

Use the standard method for saving e-mail attachments.

## ▼ Display and Verify New License Contents

Use this procedure to display a new license key file before installing it on a target library.

Prior to performing this procedure, you must download a new license key file to a system accessible to the SL Console session. See [“Receive a New License Key File”](#) on page 205.

**1. Use the SL Console to log in to the target library.**

See [“General SL Console Usage Tasks”](#) on page 47 for details.

**2. Select Tools > License Management, and click the Install License tab.**

The **Install License** screen appears.

Tools Help **License Management** Install... ?

Current License **Install License**

Type a file name and press the Enter key ( or use the Browse button )

File Name  Browse...

SL3000 Comm Status UserID: root Library:crimson12

3. In the File Name field, enter the full path of the license key file you want to display, and press Enter. Optionally, you can click Browse and navigate to the file location. The License File details appear in the lower part of the screen.

Tools Help **License Management** Install... ?

**Current License** **Install License**

Choose Install button above to initiate license installation

File Name  Browse...

Product: SL3000  
 Serial Number: 571000200030  
 Generated On: 02/12/2008:18:10:48  
 Comment Line 1: Test License for Crimson 20  
 Comment Line 2: No expired features

**License File Details**

Feature	Expiration	Value
Capacity	noExpiration	1000
Service	30Days	
Partitioning	noExpiration	
DualRobot	noExpiration	

Compare

SL3000 ✓ Comm Status UserID: root ⚠ Library:crimson20.stortek.com

---

**Note** – If the library serial number in the specified license key file does not match the serial number of the library you are logged in to, a warning appears and the license key file detail is not displayed.

---

4. Review the license key file details, and then click Compare.

The Compare Licenses popup appears.

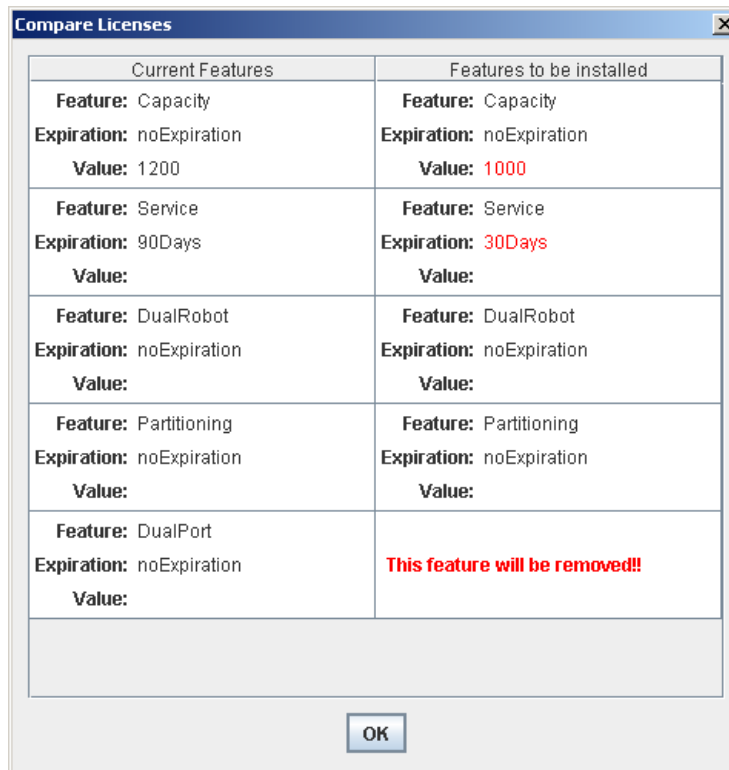

5. Review the license information.

---

**Note** – Changes that will be installed by the new license key file, such as expiration date changes or features that will be removed, are highlighted in red.

---

If there are problems with the new file, contact your Sun support representative to resolve the problems before installing the file on the target library.

---

**Caution** – There is no license “rollback” function to restore removed features once a new license key file is installed.

---

6. Click OK to dismiss the popup.

## ▼ Install a New License on the Target Library

Use this procedure to install a new license key file on the target library.

Prior to performing this procedure, you must download a new license key file to a system accessible to the SL Console session. See [“Receive a New License Key File” on page 205](#).

1. **Use the SL Console to log in to the target library.**  
See [“General SL Console Usage Tasks” on page 47](#) for details.
2. **Select Tools > License Management, and click the Install License tab.**  
The **Install License** screen appears.

Tools Help **License Management** Install... ?

Current License **Install License**

Type a file name and press the Enter key ( or use the Browse button )

File Name  Browse...

3. **In the File Name field, enter the full path of the license key file you want to install, and press Enter. Optionally, you can click Browse and navigate to the file location.**

The License File details appear in the lower part of the screen.

Tools Help **License Management** Install... ?

Current License **Install License**

Choose Install button above to initiate license installation

File Name  Browse...

**Product:** SL3000  
**Serial Number:** 571000200030  
**Generated On:** 02/12/2008:18:10:48  
**Comment Line 1:** Test License for Crimson 20  
**Comment Line 2:** No expired features

**License File Details**

Feature	Expiration	Value
Capacity	noExpiration	1000
Service	30Days	
Partitioning	noExpiration	
DualRobot	noExpiration	

Compare

SL3000 ✔ Comm Status UserID: root ⚠ Library:crimson20.stortek.com

---

**Note** – If the library serial number in the specified license key file does not match the serial number of the library you are logged in to, a warning appears and the license key file detail is not displayed.

---

**4. Review the license key file details, and then click Install in the Options Bar.**

The **License Installation Warning** popup appears.

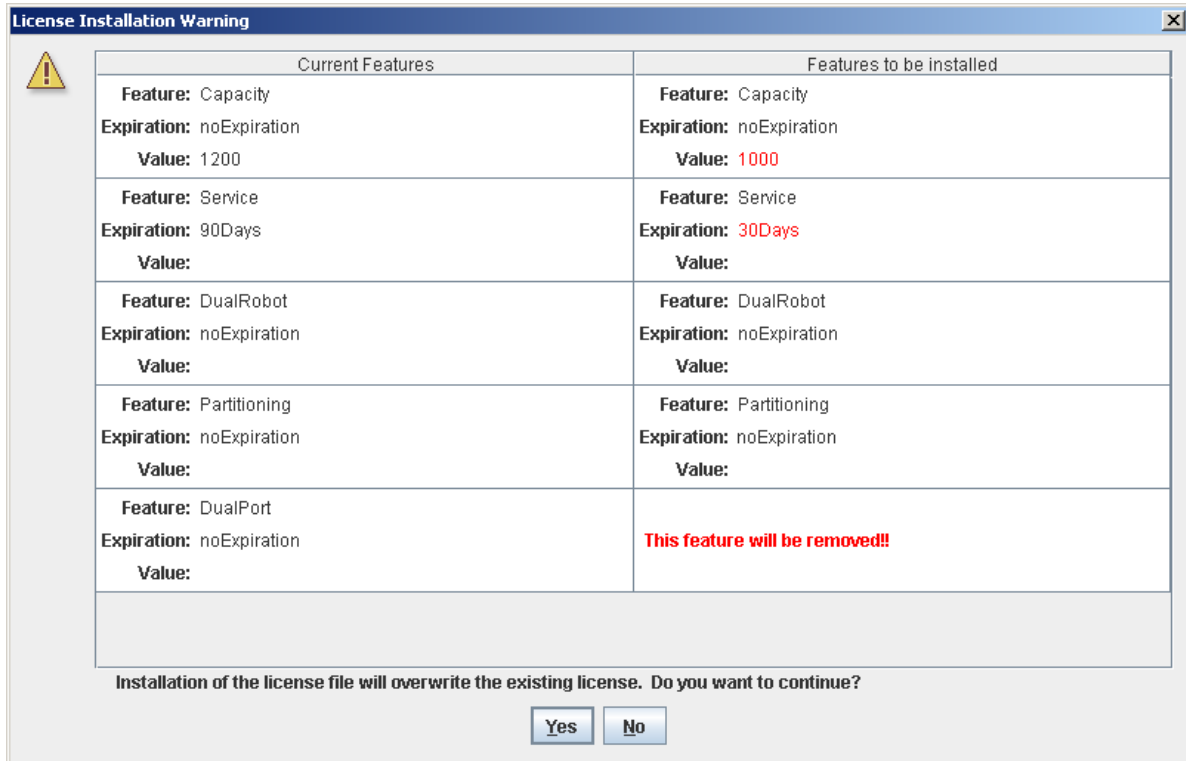

**5. Review the Features to be Installed and verify that the new license key file is accurate.**

---

**Note** – Changes that will be installed by the new license key file, such as expiration date changes or features that will be removed, are highlighted in red.

---

If there are problems with the new file, click **No** to cancel the installation. Contact your Sun support representative to resolve the problems before continuing with the installation.

---

**Caution** – There is no license “rollback” function to restore removed features once a new license key file is installed.

---

**6. If the new license key file is accurate, click Yes to begin installing the license on the target library.**

**7. The library controller verifies the license key file and proceeds as follows:**

- If there are no problems, the features included in the file are installed.

- If the new license key file is older than the one currently installed on the library, the following popup appears and the new license is not installed.

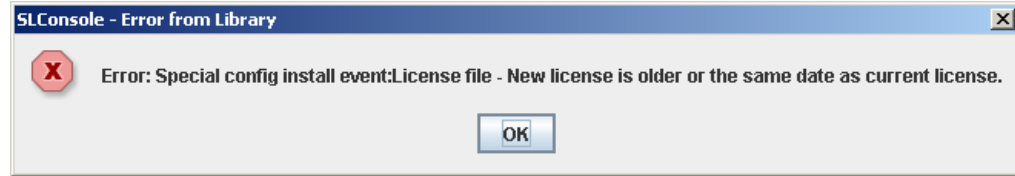

8. You can verify that the license has been installed successfully by displaying the current licenses. See ["Display Current Library License"](#) on page 212 for details.
9. Depending on the features included in the license key file, you may need to perform additional tasks in order to use the new features.
  - See ["Increasing Licensed Capacity"](#) on page 229 and ["Decreasing Licensed Capacity"](#) on page 229 for special considerations that apply when you install a license key file that changes the licensed capacity of the library.
  - See ["Installing the Partitioning Feature"](#) on page 268 for special considerations that apply when you install a license key file with the Partitioning feature.

## ▼ Display Current Library License

Use this procedure to display the features currently installed on the library you are logged in to.

1. Select **Tools > License Management**, and click the **Current License** tab.

The **Current License** screen appears, listing the currently installed features. See [“License Management > Current License”](#) on page 214 for detailed information about the screen fields.

The screenshot displays the 'Current License' screen within the 'License Management' tool. The interface includes a 'Refresh' button and a help icon. The main content is a table with the following data:

Feature	Expiration	Value	Time Remaining
Capacity	noExpiration	1200	
Service	90Days		90 Days left
DualRobot	noExpiration		
Partitioning	noExpiration		
DualPort	noExpiration		

The status bar at the bottom of the window shows the following information: SL3000, Comm Status (checked), UserID: root, and Library:crimson20.stortek.com (checked).



---

# Licensing Screen Reference

This section includes detailed descriptions of all SL Console licensing screens, arranged by screen navigation path. For example, **License Management > Install License—Compare** indicates the screen accessed by clicking **Tools** and then **License Management** from the Menu Bar, and then clicking the **Install License** tab, and then the **Compare** button.

---

**Note** – You can access the licensing screens only from the standalone SL Console or the Web-launched SL Console. They are not available on the local operator panel.

---

<b>Screen</b>	<b>Page</b>
<a href="#">License Management &gt; Current License</a>	214
<a href="#">License Management &gt; Install License</a>	216
<a href="#">License Management &gt; Install License—Compare</a>	219
<a href="#">License Management &gt; Install License—Install</a>	221

## License Management > Current License

### Sample Screen

Feature	Expiration	Value	Time Remaining
Capacity	noExpiration	1200	
Service	90Days		90 Days left
DualRobot	noExpiration		
Partitioning	noExpiration		
DualPort	noExpiration		

SL3000    Comm Status    UserID: root    Library:crimson20.stortek.com

### Description

Displays the contents of the license key file currently installed on the library you are logged in to.

You can modify the layout and display of this screen. See [“Modifying the Screen Layout” on page 36](#) for details.

### Screen Fields

#### Feature

Display only.

Name of the feature installed on the library.

#### Expiration

Display only.

Number of days until the feature is due to expire or has expired. If there is no expiration date, the field displays “noExpiration.”

**Value**

Display only.

Qualification for the feature, if applicable. For example, for the Capacity feature, this field displays the total capacity the license provides. Depending on the feature, the field may be blank or indicate “None”.

**Time Remaining**

Display only.

Amount of time remaining until the expiration of the feature. If there is no expiration date, the field is blank.

**Buttons****Refresh**

Click to refresh the display with current data from the library controller database.

**? (Help)**

Click to display online help for the screen.

**See Also**

- [License Management > Install License](#)

## License Management > Install License

### Sample Screen

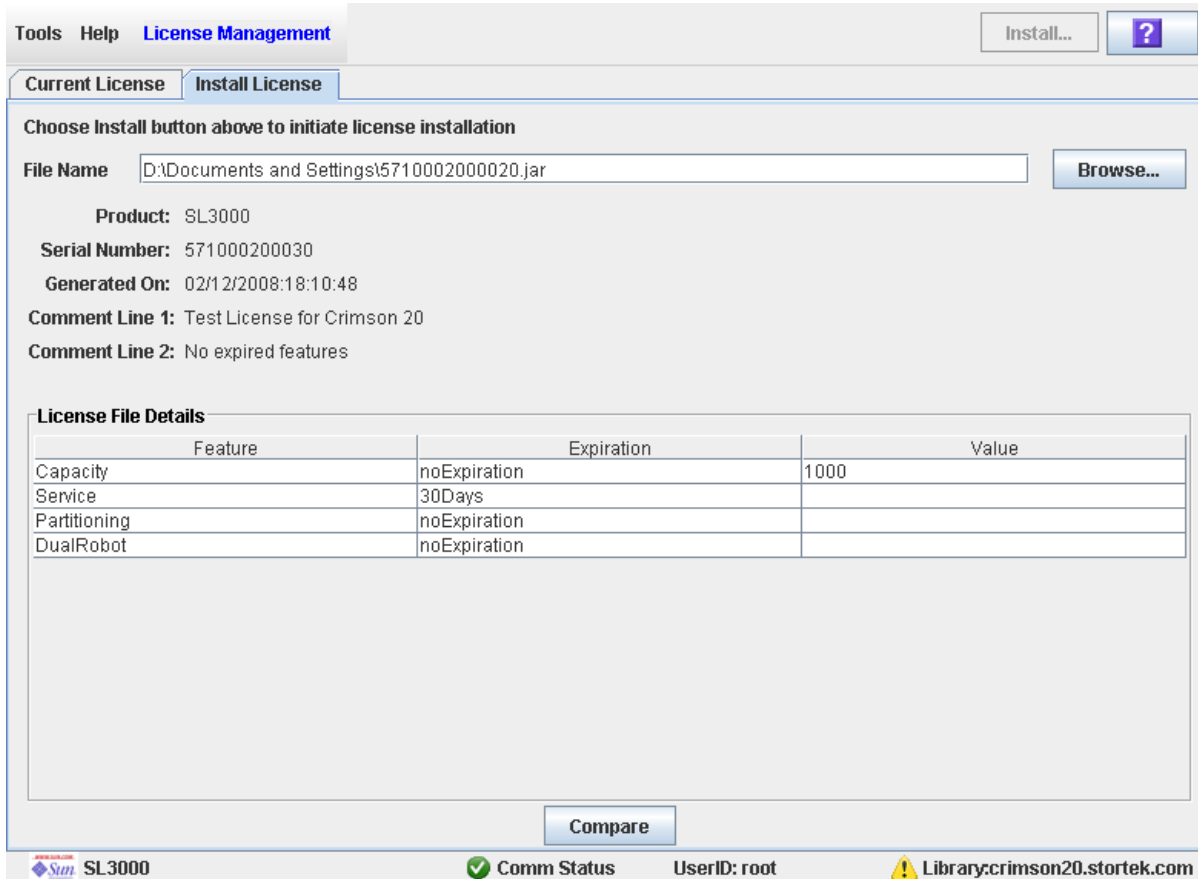

Tools Help **License Management** Install... ?

Current License **Install License**

Choose Install button above to initiate license installation



File Name  Browse...

Product: SL3000  
 Serial Number: 571000200030  
 Generated On: 02/12/2008:18:10:48  
 Comment Line 1: Test License for Crimson 20  
 Comment Line 2: No expired features

**License File Details**

Feature	Expiration	Value
Capacity	noExpiration	1000
Service	30Days	
Partitioning	noExpiration	
DualRobot	noExpiration	

Compare

SL3000  Comm Status UserID: root  Library:crimson20.stortek.com

### Description

Allows you to display the contents of a new license key file.

Also includes buttons that allow you to initiate any of the following activities:

- Compare the new license key file with the one currently installed on the library.
- Install the new license key file on the library.

You can modify the layout and display of this screen. See [“Modifying the Screen Layout” on page 36](#) for details.

### Screen Fields

#### File Name

Required.

Enter the full path of the license key file you want to install on the library. Optionally, you can click **Browse** and navigate to the file location. The file must be located on a system accessible to the SL Console session, and the serial number specified in the file must match the serial number of the library you are logged in to.

**Product**

Display only.

Type of library the license key file is for. For example, SL3000, SL8500, SL500.

**Serial Number**

Display only.

Serial number of the library the license key file is for. This entry must match the serial number of the library you are logged in to in order for the license key file to be valid for this library.

**Generated On**

Display only.

Date when the license key file was created.

**Comment Line 1**

Display only.

Optional comment concerning the license key file, from Sun Microsystems, Inc.

**Comment Line 2**

Display only.

Optional comment concerning the license key file, from Sun Microsystems, Inc.

**Feature**

Display only.

Name of a feature included in the license key file.

**Expiration**

Display only.

Number of days until the feature is due to expire. If there is no expiration date, the field displays "noExpiration."

**Value**

Display only.

Qualification for the feature, if applicable. For example, for the Capacity feature, this field displays the total amount of storage capacity the license provides. Depending on the feature, the field may be blank.

**Buttons****Install**

Click to install the displayed license key file on the library you are logged in to. The [License Management > Install License—Install](#) popup appears.

**Browse**

Click to navigate to the license key file you want to display and install.

---

**Note** – If the library serial number in the specified license key file does not match the serial number of the library you are logged in to, a warning appears and the license key file detail is not displayed.

---

### **Compare**

Click to compare the new license key file with the one currently installed on the library. The [License Management > Install License—Compare](#) popup appears.

### **? (Help)**

Click to display online help for the screen.

### **See Also**

- [License Management > Current License](#)
- [License Management > Install License—Compare](#)
- [License Management > Install License—Install](#)

## License Management > Install License—Compare

### Sample Screen

Current Features	Features to be installed
<b>Feature:</b> Capacity <b>Expiration:</b> noExpiration <b>Value:</b> 1200	<b>Feature:</b> Capacity <b>Expiration:</b> noExpiration <b>Value:</b> 1000
<b>Feature:</b> Service <b>Expiration:</b> 90Days <b>Value:</b>	<b>Feature:</b> Service <b>Expiration:</b> 30Days <b>Value:</b>
<b>Feature:</b> DualRobot <b>Expiration:</b> noExpiration <b>Value:</b>	<b>Feature:</b> DualRobot <b>Expiration:</b> noExpiration <b>Value:</b>
<b>Feature:</b> Partitioning <b>Expiration:</b> noExpiration <b>Value:</b>	<b>Feature:</b> Partitioning <b>Expiration:</b> noExpiration <b>Value:</b>
<b>Feature:</b> DualPort <b>Expiration:</b> noExpiration <b>Value:</b>	<b>This feature will be removed!!</b>

OK

### Description

Allows you to compare the following sets of license information:

- Features currently installed on the library you are logged in to.
- Features included in the new license key file you have specified in the [License Management > Install License](#) screen.

---

**Note** – Changes that will be installed by the new license key file, such as expiration date changes or features that will be removed, are highlighted in red.

---

This screen is a popup that appears when you click **Compare** on the [License Management > Install License](#) screen.

### Screen Fields

#### Current Features

Display only.

List of features, expiration dates, and values for all features currently installed on the library you are logged in to.

### **Features to be Installed**

Display only.

List of features, expiration dates, and values for all features included in the specified new license key file. Changes that will be installed by the new license key file, such as expiration date changes or features that will be removed, are highlighted in red.

### **Buttons**

#### **OK**

Click to dismiss the popup and return to the previous screen.

### **See Also**

- [License Management > Install License](#)
- [License Management > Install License—Install](#)



## License Management > Install License—Install

### Sample Screen

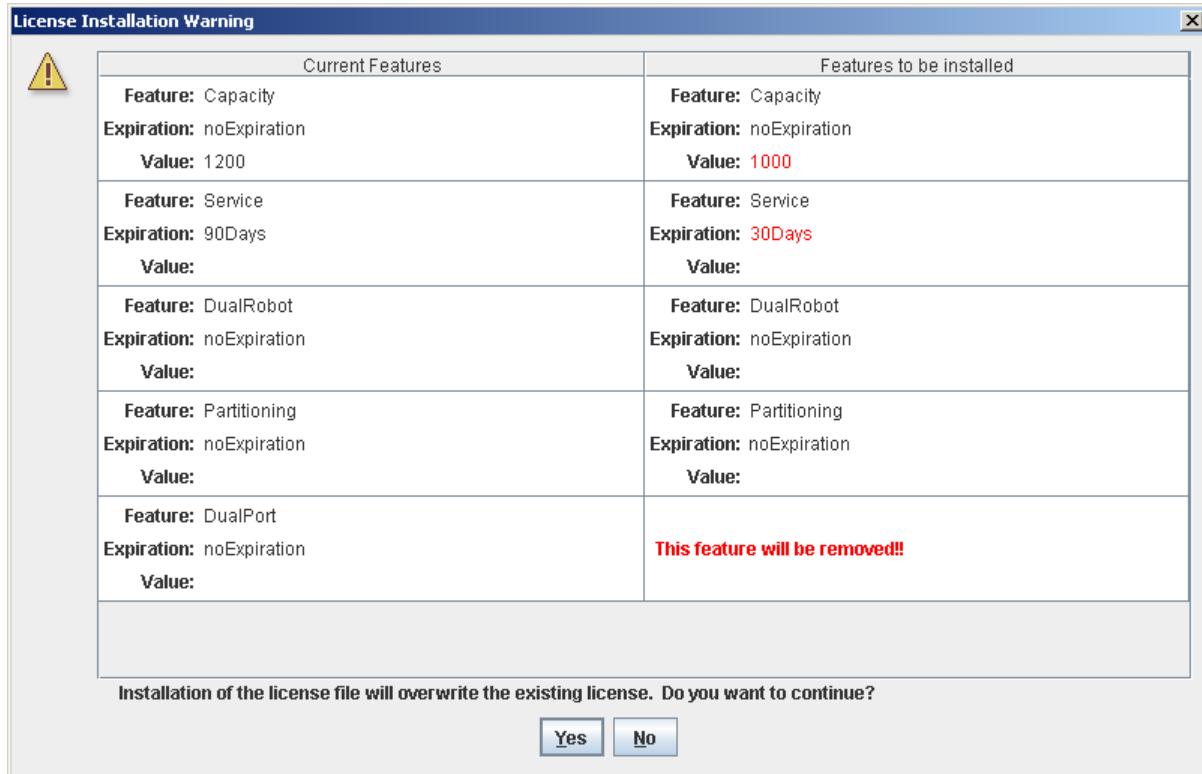

### Description

Allows you to compare the following sets of license information:

- Features currently installed on the library you are logged in to.
- Features included in the new license key file you have specified in the [License Management > Install License](#) screen.

Warning messages are displayed if installation of the new license key file will result in features being removed from the library.

After comparing the license information, you can install the new license key file on the library by clicking the **Yes** button.

---

**Caution** – It is very important that you carefully verify the accuracy of the new license key file before installing it, as there is no “rollback” function to restore removed features.

---

This screen is a popup that appears when you click **Install** on the [License Management > Install License](#) screen.

Depending on the features included in the license key file, you may need to perform additional tasks in order to use the new features.

- See [“Increasing Licensed Capacity” on page 229](#) and [“Decreasing Licensed Capacity” on page 229](#) for special considerations that apply when you install a license key file that changes the licensed capacity of the library.
- See [“Installing the Partitioning Feature” on page 268](#) for special considerations that apply when you install a license key file with the Partitioning feature.

## Screen Fields

### Current Features

Display only.

List of features, expiration dates, and values for all features currently installed on the library you are logged in to.

### Features to be Installed

Display only.

List of features, expiration dates, and values for all features included in the specified new license key file. Warning messages are displayed if installation of the license key file will result in features being removed from the library.

## Buttons

### Yes

Click to install the specified license key file on the library. The library controller verifies the validity of the license key file and installs it.

### No

Click to cancel the update and return to the previous screen.

## See Also

- [License Management > Install License](#)
- [License Management > Install License—Compare](#)

## Capacity on Demand

---

The SL3000 library includes RealTimeGrowth™ and Capacity on Demand features. RealTimeGrowth allows you to install physical storage capacity beyond your current needs. Capacity on Demand separates physical from licensed capacity and allows you to pay only for the capacity you need. Then as your needs grow, you can expand storage capacity with minimal disruption to library operations. To activate additional capacity, you need only purchase and install a license key file for the new capacity.

---

**Note** – Library storage capacity must be installed through the SL3000 licensing utility. See [Chapter 4, “Licensing”](#) for details.

---

---

**Note** – This feature controls cartridge storage cells only. All installed CAPs and tape drives are active by default.

---

---

## Capacity on Demand Features and Restrictions

This section describes important features and restrictions of Capacity on Demand that will help you to plan for and use the feature in your SL3000 library.

- The minimum licensed capacity is 200 storage cells.
- The maximum licensed capacity is equal to the physical capacity of the library, which is 5821 cells.
- You can purchase additional licensed capacity in increments of 1, 100, 200, 500, or 1000 cells.
- Installation of additional licensed capacity results in minimal disruption to library operations. Once verified by the library controller, the additional storage cells are available immediately; you do not need to reboot the library. Depending on the host interface (HLI or FC-SCSI), there may be a brief interruption in host operations as the hosts update the new resource information. See [“Non-disruptive Capacity Changes” on page 227](#) for details.
- A library’s current licensed storage capacity is equal to the capacity specified in the most recently installed license key file.

- Changes to active capacity can be made with minimal disruptions to library operations. See [“Non-disruptive Capacity Changes” on page 227](#) for details.

## Terminology

The following terms are used to describe library capacity management:

- Physical or installed capacity – The number of storage cells physically present in the library.
- Licensed capacity – The number of storage cells the library is licensed to use. This cannot exceed the installed capacity.
- Active capacity – The number of licensed storage cells that are activated for use. By default, this is the same as the licensed capacity. You can optionally de-activate selected storage cells, making this less than the licensed capacity.
- Active storage region – A rectangular area of storage cells that are activated for use. An active storage region can be as small as a single storage cell or as large as the total licensed capacity for the library.
- Active cell – A storage cell that is activated for use. Only activated cells can be used for cartridge storage.
- Inactive cell – A storage cell that is explicitly de-activated and therefore cannot be used for cartridge storage.
- Selected cell – A storage cell that is not currently active, but will be activated automatically by the library controller when licensed capacity is increased.

---

## Active Storage Region Configuration

Active storage regions can be assigned automatically by the library controller or manually by the user. Automatic assignment by the library controller provides balanced growth of library modules.

Individual storage cells can be in either of the following states:

- Active – The cell can be used for cartridge storage.
- Inactive – The cell has been de-activated, and therefore cannot be used for cartridge storage. You can monitor the cell on library displays and reports, but requests to move cartridges to the cell are rejected by the library controller.
- Selected – The cell is not currently active, but will be activated automatically by the library controller when licensed capacity is increased. This state applies to non-partitioned libraries only.

Only active storage cells can be used for tape cartridge storage. Inactive storage cells cannot be used for cartridge storage, nor can they be accessed by any hosts.

## Cell Activation Rules

The library controller uses the following rules when adding cells to active storage regions:

- Cell activation starts in the left upper rear of the active storage region and moves to the right lower front.
- All cells within a column are activated from top to bottom before moving to the next column.
- Columns within a panel are activated from left to right.

## Non-Partitioned Libraries

Within a non-partitioned library, the library controller automatically selects all physical cells, but only activates a number of cells up to the total licensed capacity of the library. Selected cells that cannot be activated due to licensed capacity limits remain selected and will be activated automatically whenever additional licensed capacity is installed.

When activating cells, the library controller begins at the back of the library, starting with the left-most module and working to the right. Then it moves to the front of the library, starting with the left-most module and working to the right.

To optimize cartridge placement, you can optionally designate active storage regions in the library, within which the library controller applies the rules above.

## Partitioned Libraries

In partitioned libraries, the total number of storage cells allocated to all library partitions cannot exceed the licensed capacity of the library.

In partitioned libraries, there is no default active storage region. You must explicitly assign storage cells to partitions, thereby configuring the active storage regions for each partition. See [“Partitioning Process” on page 283](#) for details.

When placing cartridges in storage cells, the library controller applies the predefined cell activation rules separately to each partition. See [“Cell Activation Rules” on page 225](#) for details.

## De-activating Storage Capacity

You can optionally reduce the size of an active storage region by de-activating designated storage cells. A warning message is displayed if cartridges will be orphaned due to the capacity reduction.

## Orphaned Cartridges in Non-Partitioned Libraries

---

**Note** – For a discussion of orphaned cartridges in partitioned libraries, see [“Orphaned Cartridges in Partitioned Libraries” on page 273](#).

---

In non-partitioned libraries, an orphaned cartridge is a cartridge located in an inactive storage cells. Orphaned cartridges are inaccessible to all hosts.

A cartridge can become orphaned for a variety of reasons. Following are some possible causes:

- Active storage capacity has been reduced.
- The cartridge has been moved to an inactive or inaccessible cell through manual intervention.

If the SL Console identifies an orphaned cartridge, it displays a warning message. You can then use the following tools to help you resolve and disposition the orphaned cartridge:

- Generate a report of orphaned cartridges.
- Perform an audit of the library.
- Perform a recovery move on a cartridge.

For detailed instructions on checking for and resolving orphaned cartridges, see the following procedures:

- [“Display an Active Storage Region Report” on page 239](#)
- [“Commit Active Storage Region Changes” on page 236](#)

---

# Non-disruptive Capacity Changes

Changes to active capacity result in minimal disruptions to library operations. The specific library behavior depends on the type of host connection, as described in the following sections:

- [“Active Capacity Changes and HLI Connections” on page 227](#)
- [“Active Capacity Changes and FC-SCSI Connections” on page 228](#)

---

**Caution** – Although changes to active capacity are not disruptive to library hosts, it is recommended that you make the library unavailable to other users before committing your active storage region changes. Because the SL Console does not validate storage region boundaries against the library controller database in real-time, configuration conflicts may arise if you change active storage region boundaries while other users are performing cartridge movements or library configuration changes. See [“Synchronizing the Display With the Controller Database” on page 36](#) for details.

---

## Active Capacity Changes and HLI Connections

With HLI libraries, you can increase active capacity without stopping host jobs or having host connections go offline. When you decrease capacity, the library goes offline only momentarily and then comes back online automatically.

### Adding Active Capacity

Whenever you add active storage cells, the library stays online. The library controller sends an asynchronous message to all hosts notifying them that the library configuration has changed. The hosts experience a brief interruption as they update their library configuration information, and then they automatically continue processing jobs.

### Removing Active Capacity

Whenever you make any of the following types of capacity changes, the library goes offline temporarily.

- De-activate a storage cell
- Remove an empty drive slot

After the configuration change is updated in the library controller database, the library comes back online and the library controller sends an asynchronous message to all hosts notifying them that the library configuration has changed. The hosts experience a brief interruption as they update their library configuration information, and then they automatically continue processing jobs.

## Active Capacity Changes and FC-SCSI Connections

With FC-SCSI libraries, whenever you make any of the following changes, the library goes offline temporarily with a Unit Attention condition:

- Activate or de-activate a storage cell
- Add, change, or remove a host connection
- Remove an empty drive slot

Multiple error messages may be generated, and all hosts must issue the appropriate commands to update their library configuration information. See the appropriate tape management software documentation for detailed procedures and commands. In the case of adding or removing drives, the device SCSI numbering is updated as well.



---

## Increasing Licensed Capacity

The following special considerations apply after you successfully install a capacity license providing additional capacity. See [Chapter 4, “Licensing” on page 201](#) for details on installing license key files.

- The new library capacity is equal to the capacity specified in the most recently installed license key file.
  - You do not need to reboot the library in order to begin using the new capacity, but you must configure all affected library host applications to recognize the new capacity. See [“Non-disruptive Capacity Changes” on page 227](#) for details.
  - If the new licensed capacity exceeds the physical capacity, a warning is displayed. No corrective action is necessary.
  - If the library is not partitioned, the library controller automatically activates cells that have not been explicitly de-activated by the user previously. In this case, no user intervention is required to make the new licensed capacity available. If cells have been de-activated, however, you may need to manually select cells in order to start using the additional capacity.
  - If the library is partitioned, all new capacity is added as unallocated cells. You must allocate new storage cells to partitions manually in order to start using the cells; see [“Design a Partition – Base, DEM, or CEM Modules” on page 291](#) for details.
- 

## Decreasing Licensed Capacity

The following special considerations apply after you successfully install a capacity license resulting in reduced capacity. See [Chapter 4, “Licensing” on page 201](#) for details on installing license key files.

---

**Note** – Installing reduced capacity is an exceptional situation; be sure this is what you really want to do before installing the license key file.

---

- A warning appears if cartridges will be orphaned as a result of the reduced capacity. See [“Orphaned Cartridges in Non-Partitioned Libraries” on page 226](#) for details.
- For non-partitioned libraries:
  - The new, reduced capacity takes effect immediately.
  - The library controller de-activates cells in reverse order of their activation – the cells activated most recently are de-activated first.
- For partitioned libraries:
  - If the total number of cells allocated to all partitions exceeds the new licensed capacity, the library is automatically taken offline. You must manually de-allocate cells from partitions so the total allocation does not exceed the new licensed capacity.
  - If the total number of cells allocated to all partitions is still less than the new licensed capacity, the new reduced capacity takes effect immediately with no change to the existing partition allocations. The library continues operations without interruption.

---

# Capacity Management Tasks

This section provides detailed instructions for all tasks involved in implementing and managing active storage capacity in the library.

## Storage Capacity Installation Process

Following is a summary of the process used to install new library storage capacity.

1. You purchase and install a capacity license for the library. See [“License Installation Process” on page 203](#) for details.
2. The new licensed capacity is available immediately. You do not need to re-boot the library.
3. In non-partitioned libraries, by default, all newly activated cells are immediately available for use. Proceed as follows:
  - If you want to use the default storage region configuration assigned by the library controller, you must configure all affected library host applications to recognize the new storage regions. See [“Non-disruptive Capacity Changes” on page 227](#) for details.
  - If you want to modify the storage region configuration from the default, see [“Define Active Storage Regions” on page 233](#).
4. In partitioned libraries, all newly activated cells are added as “unallocated,” and are therefore not available for use. You must manually allocate the new cells to partitions. See [“Partitioning Process” on page 283](#) for detailed instructions.

## SL Console Active Storage Region Workspace

The **Select Active Cells** screens, and all associated popups, give you a dynamic workspace to customize your licensed capacity configuration. All licensed capacity configuration information is automatically saved to the active storage region workspace in SL Console memory and retained for the duration of your SL Console session. This allows you to switch among active storage region views and leave and return to the **Select Active Cells** screens any number of times without losing your configuration changes.

Information in the SL Console active storage region workspace is committed to the library controller database only through the **Apply** button on the [Select Active Cells > Select Active Cells](#) screen. The information is lost if any one of the following occurs before you have committed your updates:

- You actively log off the SL Console session.
- The SL Console session times out or the connection to the library is lost.
- You actively refresh the active storage region workspace from the current library controller database. This is done through the **Refresh** button on the **Select Active Cells** screens.

---

**Caution** – Although changes to active capacity are not disruptive to library hosts, it is recommended that you make the library unavailable to other users before committing your active storage region changes. Because the SL Console does not validate storage region boundaries against the library controller database in real-time, configuration conflicts may arise if you change active storage region boundaries while other users are performing cartridge movements or library configuration changes. See [“Synchronizing the Display With the Controller Database” on page 36](#) for details.

---

---

# Capacity Management Tasks

---

**Note** – The following tasks apply to non-partitioned libraries only. For detailed instructions on configuring storage regions for partitioned libraries, see [“Partitioning Process” on page 283](#).

---

---

**Note** – The following tasks can be performed only from the standalone SL Console or the Web-launched SL Console. They cannot be performed at the local operator panel.

---

<b>Task</b>	<b>Page</b>
<a href="#">Define Active Storage Regions</a>	233
<a href="#">Commit Active Storage Region Changes</a>	236
<a href="#">Display an Active Storage Region Report</a>	239
<a href="#">Print Active Storage Region Report Data</a>	241
<a href="#">Save Active Storage Region Report Data</a>	242
<a href="#">Display Active Cell Detail</a>	243

## ▼ Define Active Storage Regions

---

**Note** – See [“License Installation Process” on page 203](#) for information about installing licensed capacity.

---

When you install additional licensed capacity, the library controller automatically activates the number of storage cells equal to the licensed capacity. It uses a set of internal rules when choosing the actual cells to activate. See [“Active Storage Region Configuration” on page 224](#) for details.

Use this procedure only if you want to do one of the following:

- Customize the active storage regions so they are different from the default configuration assigned by the library controller. For example, you can configure active storage cells so that cartridges are concentrated around the drives and the ends of the library are left for future growth.
- De-activate storage cells, so the total number of active storage cells is less than the licensed capacity.
- De-select storage cells, so these cells will not be automatically activated when the library’s licensed capacity is increased.

---

**Note** – If you want to use the default storage region configuration defined by the library controller, you do not need to use this procedure.

---

1. Select Tools > Select Active Cells.

The **Module Map** screen appears.

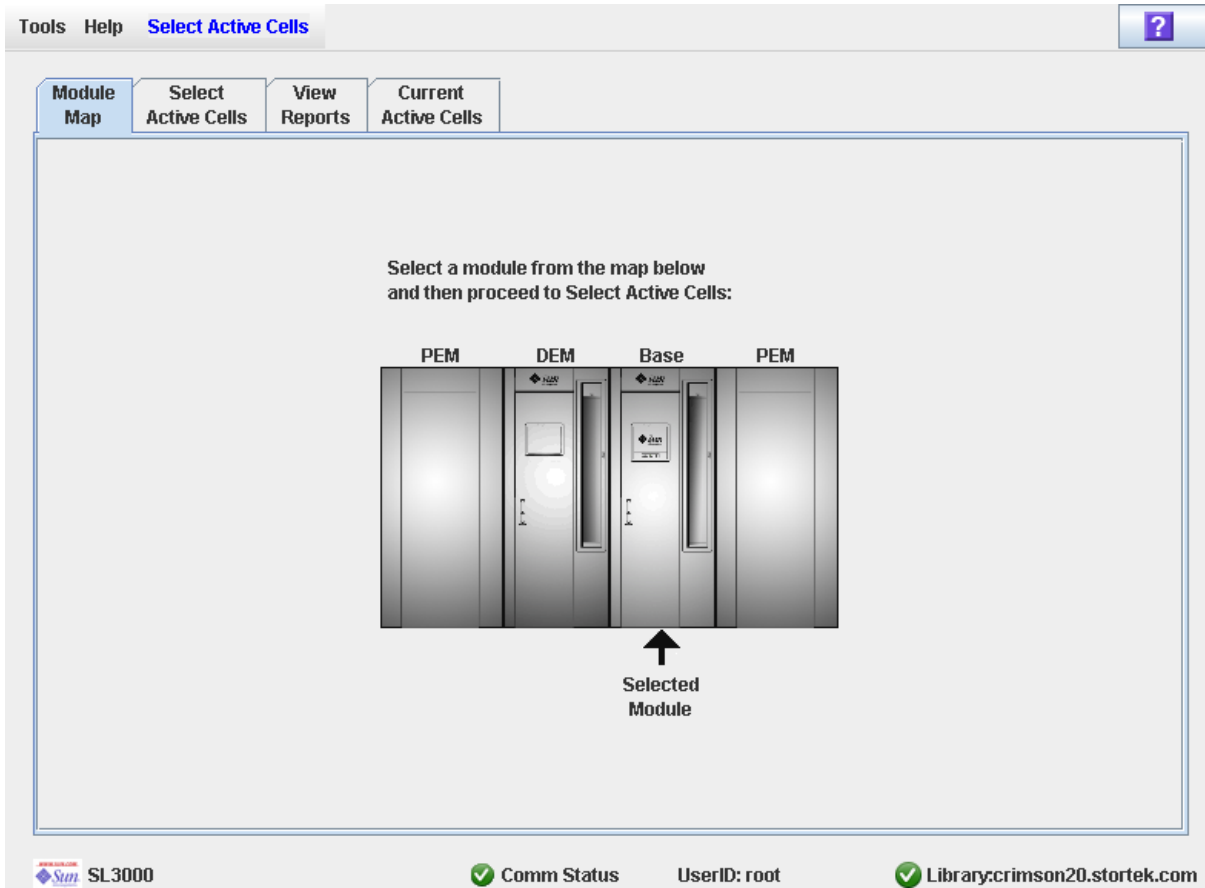

2. Click the module for which you want to define the active storage regions.

3. Click the **Select Active Cells** tab.

The **Select Active Cells** screen appears, displaying the current configuration of the module you have selected.

**Note** – The first time you display this screen, the number of selected cells is equal to the physical capacity of the library, and the number of active cells is equal to the library's total licensed capacity.

**Note** – Click the **Move Left** or **Move Right** buttons to display a module directly adjacent to the one currently displayed.

4. Choose the **Select by** method, and click either the **Add** or **Remove** radio button.
5. Use the library map to select the storage cells you want to activate or de-activate.

**Note** – See [“Select Active Cells > Select Active Cells”](#) on page 248 for detailed instructions on using the library map.

Your capacity configuration changes are saved to the SL Console active storage region workspace for the duration of this login session. You can make additional modifications and leave and return to the **Select Active Cells** screens any number of times without losing your changes.

6. When you are done making changes, proceed to [“Commit Active Storage Region Changes”](#) on page 236 to verify and commit your changes.

## ▼ Commit Active Storage Region Changes

Use this procedure to verify and commit active storage region configuration changes you have made on the **Select Active Cells** screen. This procedure warns you of the following possible errors:

- The library has orphaned cartridges. See [“Orphaned Cartridges in Non-Partitioned Libraries” on page 226](#) for details.
- Cells will be made inaccessible to library hosts.

---

**Caution** – Although changes to active capacity are not disruptive to library hosts, it is recommended that you make the library unavailable to other users before committing your active storage region changes. Because the SL Console does not validate storage region boundaries against the library controller database in real-time, configuration conflicts may arise if you change active storage region boundaries while other users are performing cartridge movements or library configuration changes. See [“Synchronizing the Display With the Controller Database” on page 36](#) for details.

---

1. Perform the steps in [“Define Active Storage Regions” on page 233](#).

The changes you have made are displayed on the **Select Active Cells** screen.

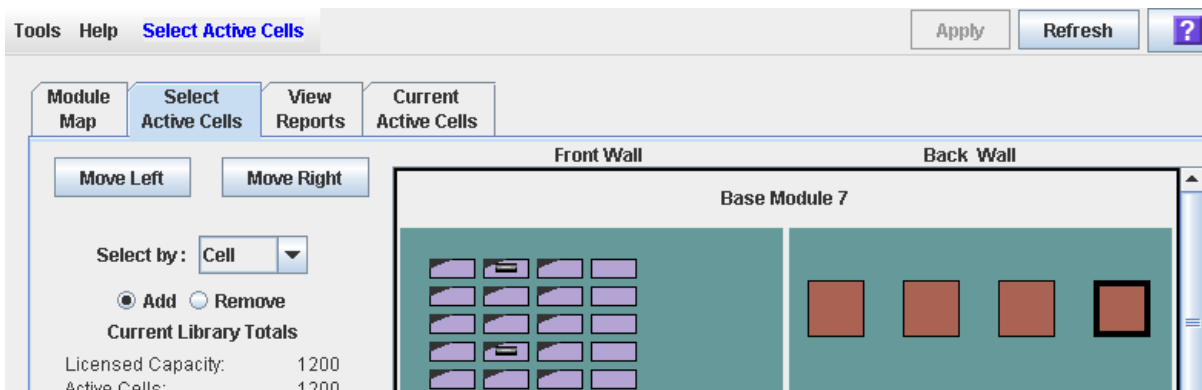

2. In the Options Bar, click **Apply**.

The boundaries of the active storage regions are verified, including the locations of all tape cartridges.



**Note** – This verification is performed only on the active storage region configuration defined in the **Select Active Cells** screens. It does not verify active storage regions against the library controller database; therefore it cannot identify configuration conflicts that may arise due to other users performing cartridge movements or library configuration changes—through the command line interface, other SL Console sessions, or host applications—at the same time you have made changes to active storage regions.

The **Confirm Apply** popup appears, indicating whether there are any orphaned cartridges or other problems in the active storage region configuration.

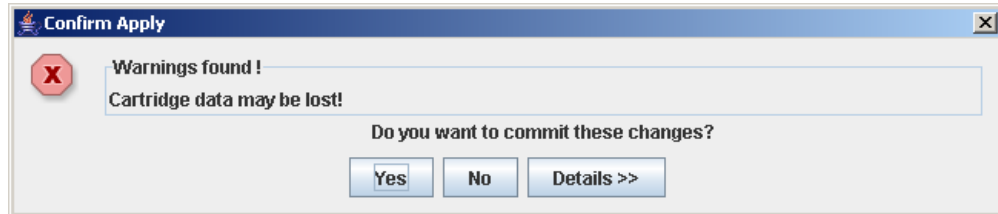

- To display detailed warning messages explaining the reasons for any orphaned cartridges, click **Details**.

You can use the **Details** button to toggle between the expanded and collapsed views of the warning messages.

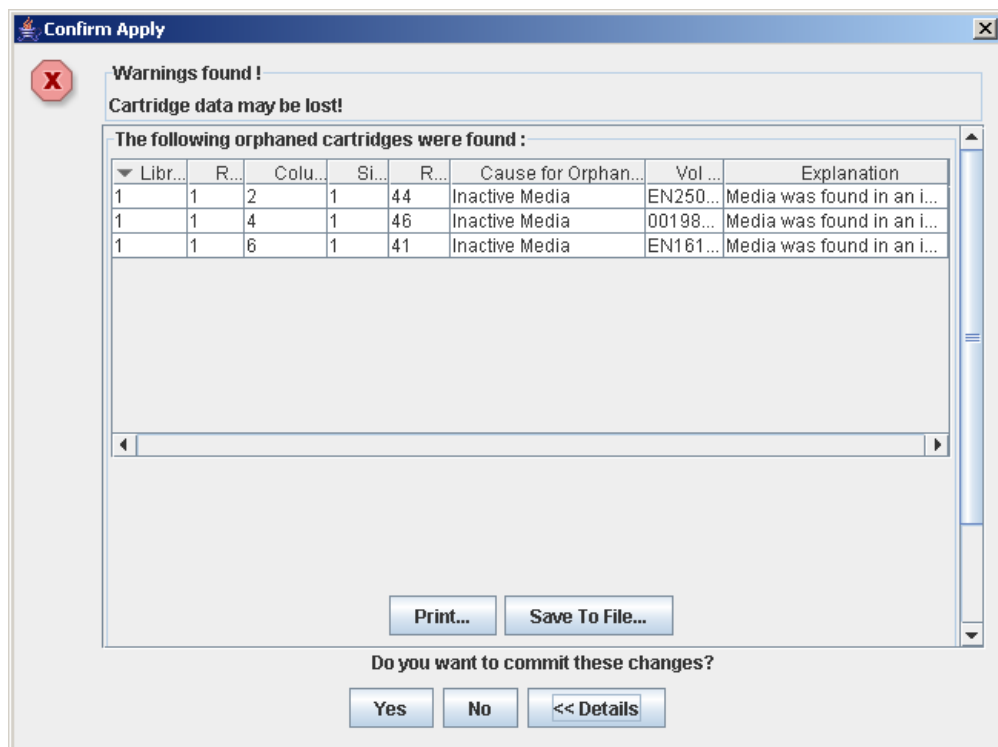

- Optionally, in the expanded view of the warning messages you can do the following:
  - Click **Print** to print the detailed message data.
  - Click **Save to File** to save the detailed message data to a comma-separated file.
- Proceed as follows:

- Click **No** to cancel the update.  
The library controller database is not updated, but all changes you have made are retained on the **Select Active Cells** screen.
- Click **Yes** to make the following updates to the library controller database and proceed to [Step 6](#).
  - White cells with a “dog-eared” left corner are made inactive.
  - Purple cells without a “dog-eared” left corner are made active, up to the total licensed capacity of the library. Purple cells that cannot be activated due to licensed capacity limits will remain purple and will be activated automatically whenever additional licensed capacity is installed.
  - All other cells are left unchanged.

The **Commit Success** popup appears.

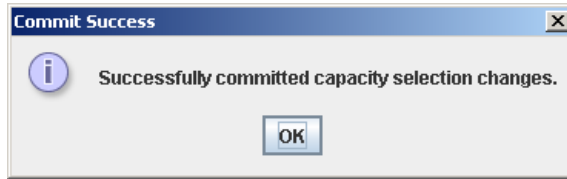

6. **Click OK to return to the Select Active Cells screen.**  
All newly activated cells are immediately available for use; the library does not need to be rebooted.
7. **All affected library host applications must now be configured to recognize these updates. See the appropriate tape management software documentation for the procedures and commands.**

## ▼ Display an Active Storage Region Report

Use this procedure to display the following active storage region reports:

- Cartridge Cell and Media Summary – Displays a detailed list of all library resources and their status (active or inactive).
- Orphaned Cartridge Report – Displays a detailed list of all orphaned cartridges.

---

**Note** – The active storage region reports display data saved to the library controller database. If you have made changes to the active storage region configuration without committing the changes to the library controller, the data in these reports will differ from data shown on **Select Active Cells** screen.

---

1. **Select Tools > Select Active Cells, and click the View Reports tab.**

The **View Reports** screen appears.

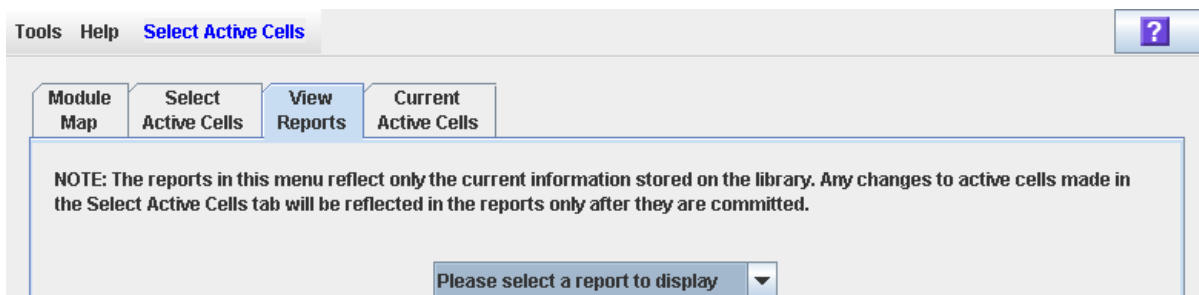

2. In the pull-down menu, select the report you want to display.

The screen is updated with current data from the library controller database.

Tools Help **Select Active Cells** ?

Module Map **Select Active Cells** **View Reports** Current Active Cells

NOTE: The reports in this menu reflect only the current information stored on the library. Any changes to active cells made in the Select Active Cells tab will be reflected in the reports only after they are committed.

Cartridge Cell and Media Summary ▼

Cell and Media Summary as of 3/7/08 11:03 AM

▼ Library	Rail	Column	Side	Row	Element Type	Vol Ser	Cell Status
1	1	-9	1	1	CELL		Active
1	1	-9	1	2	CELL		Active
1	1	-9	1	3	CELL		Active
1	1	-9	1	4	CELL		Active
1	1	-9	1	5	CELL		Active
1	1	-9	1	6	CELL		Active
1	1	-9	1	7	CELL		Active
1	1	-9	1	8	CELL		Active
1	1	-9	1	9	CELL		Active

Print... Save To File...

SL3000 ✓ Comm Status UserID: root ✓ Library:crimson20.stortek.com

3. If you want to print the report data or save it to a file, see the following procedures:

- [“Print Active Storage Region Report Data” on page 241](#)
- [“Save Active Storage Region Report Data” on page 242](#)

## ▼ Print Active Storage Region Report Data

Use this procedure to print an active storage region report. This procedure can be performed from any of the active storage region report screens.

1. Select **Tools > Select Active Cells**, and click the **View Reports** tab.

The **View Reports** screen appears.

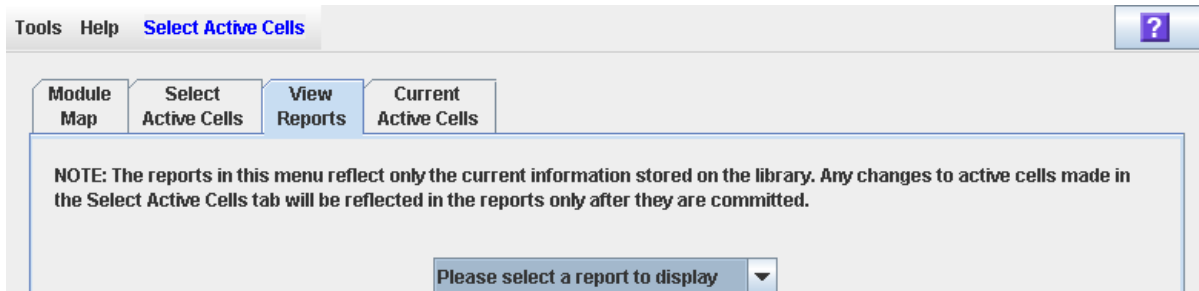

2. In the pull-down menu, select any report.

The specified report is displayed. All report screens include the **Print** and **Save to File** buttons.

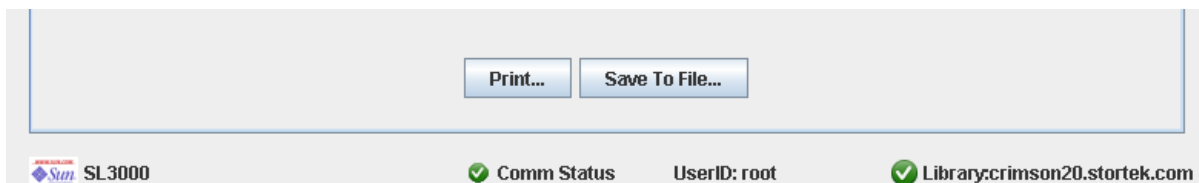

3. Click **Print**.

The **Print** popup appears.

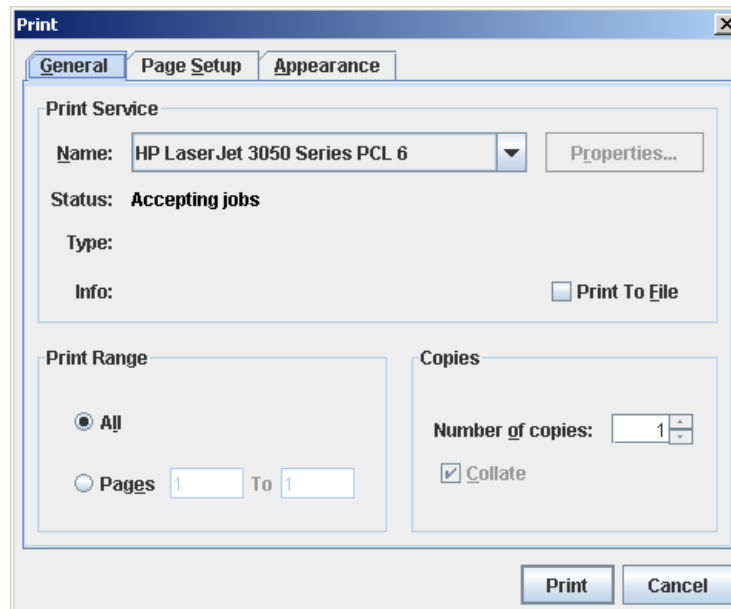

4. Complete the print popup, and click **Print**.

The report is printed to the selected printer.

## ▼ Save Active Storage Region Report Data

Use this procedure to save active storage region report data to a comma-separated file (.csv format). You can use a variety of spreadsheet applications to view the file. This procedure can be performed from any of the active storage region report screens.

1. **Select Tools > Select Active Cells, and click the View Reports tab.**

The **View Reports** screen appears.

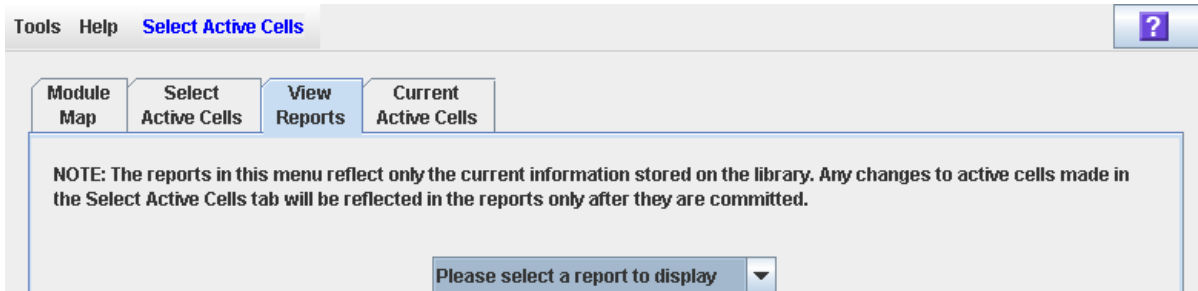

2. **In the pull-down menu, select any report.**

The specified report is displayed. All report screens include the **Print** and **Save to File** buttons.

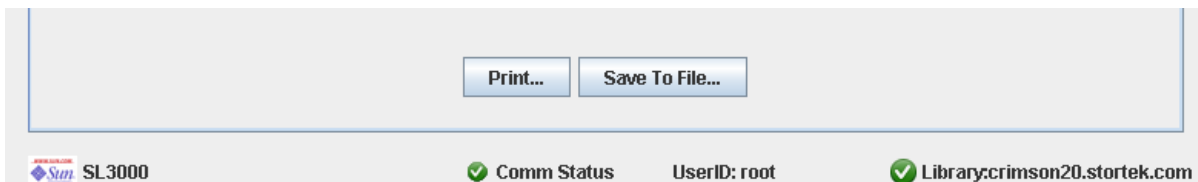

3. **Click Save to File.**

The **Save** popup appears.

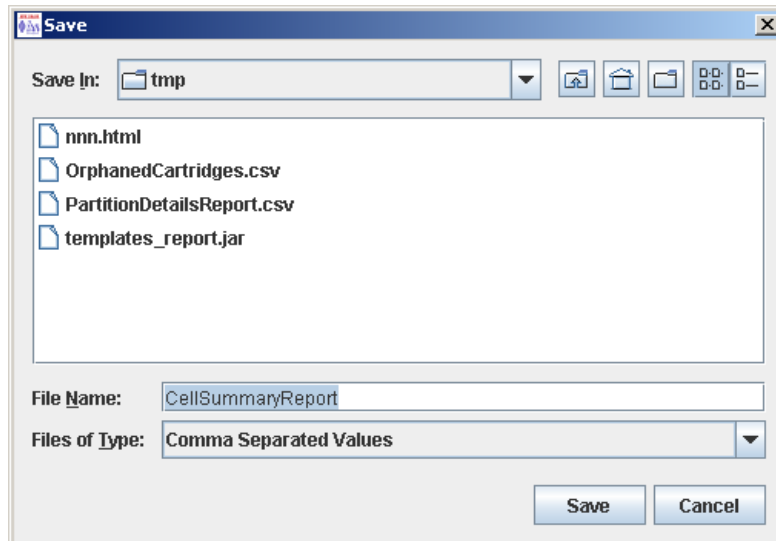

4. **Browse to the directory where you want to save the file, and enter the file name.**

5. **Click Save.**

The data is saved to the specified file.

## ▼ Display Active Cell Detail

Use this procedure to display which storage cells are currently active, inactive, or selected for activation. You can also display detailed information about cartridge, drive, and storage cell locations.

---

**Note** – This procedure is available on the local operator panel.

---

### 1. Select Tools > Select Active Cells.

The **Module Map** screen appears.

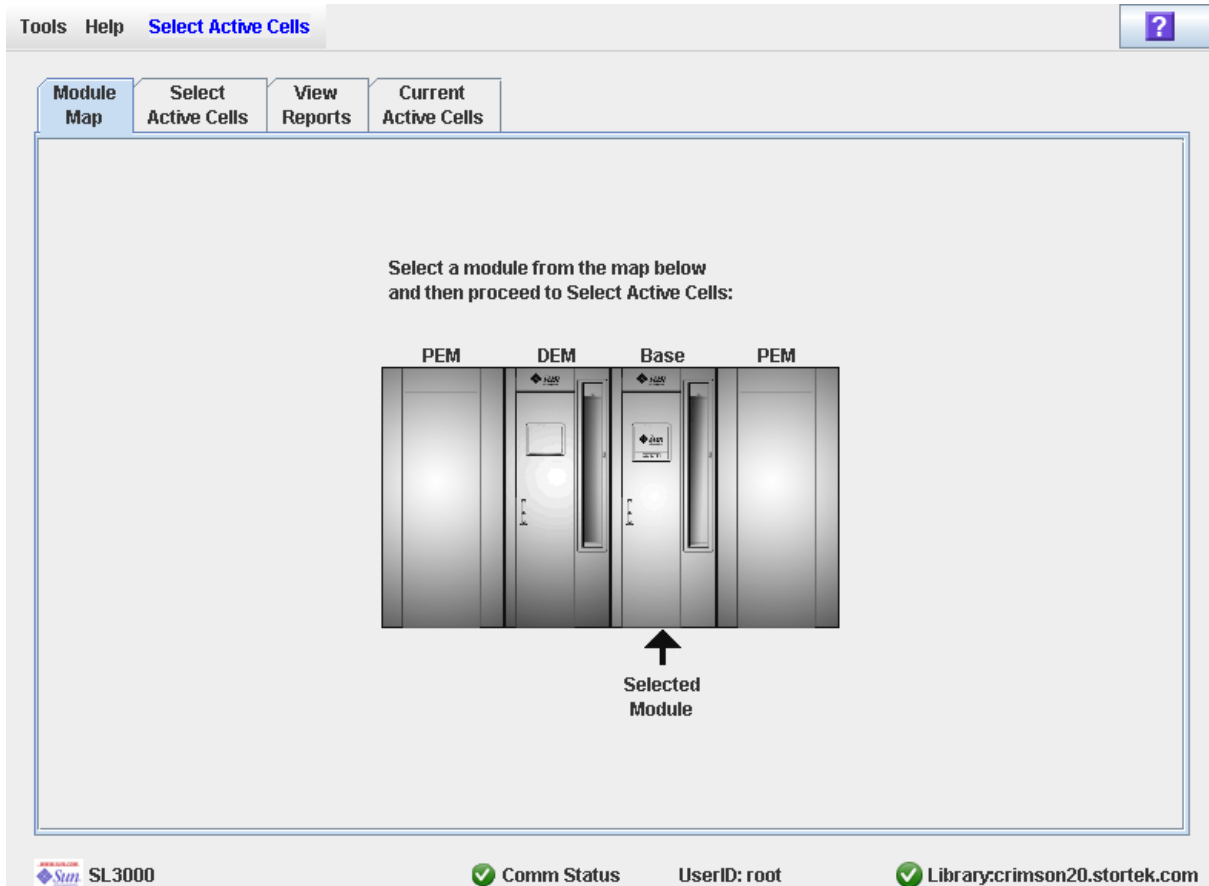

### 2. Click the module you want to display.

3. Click the **Current Active Cells** tab.

The **Active Cells** screen appears, displaying the current configuration of the module you have selected.

You can mouse-over a cell or drive to display a tooltip of detailed information.

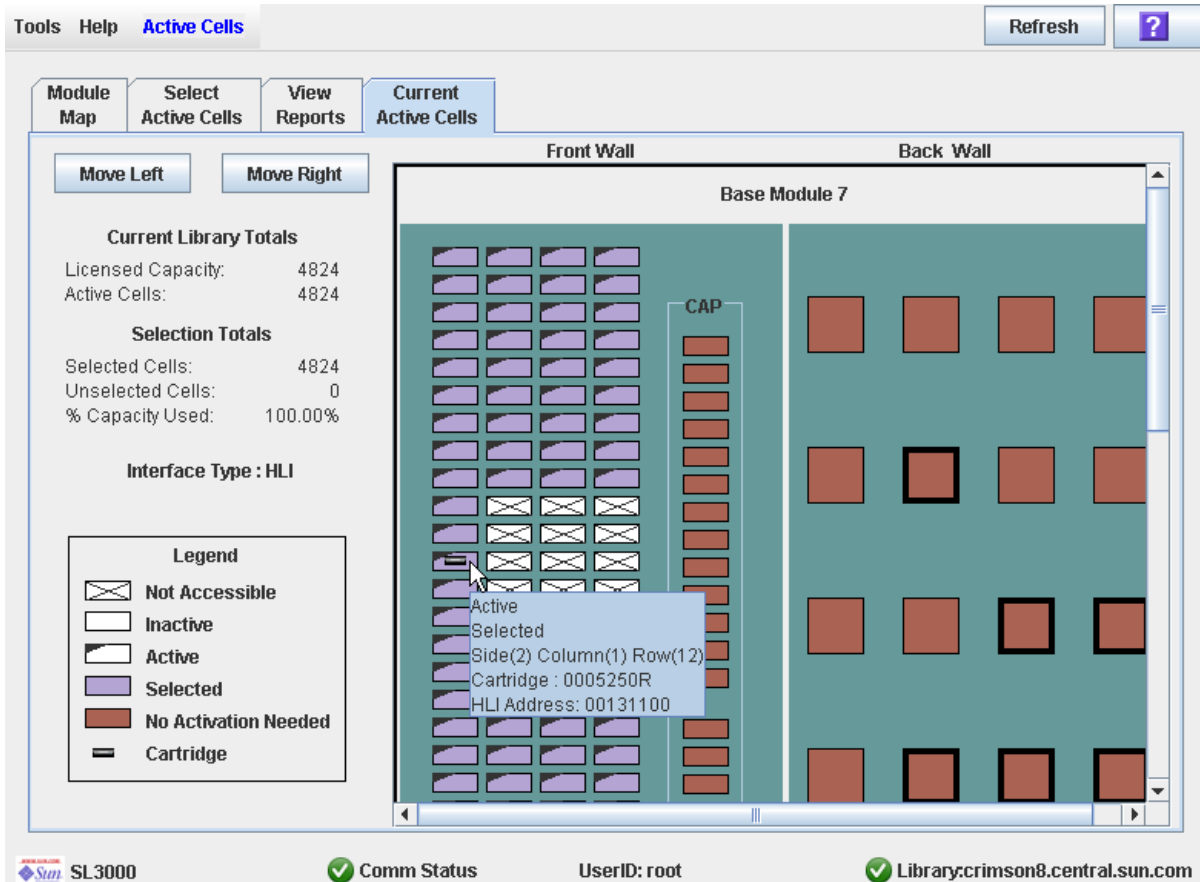



---

# Active Storage Region Screen Reference

This section includes detailed descriptions of all SL Console active storage region screens, arranged by screen navigation path. For example, **Select Active Cells—Select Active Cells—Confirm Apply** indicates the screen accessed by clicking **Tools** and then **Select Active Cells** from the Menu Bar, and then clicking the **Select Active Cells** tab, and then the **Confirm Apply** button.

---

**Note** – These screens are available for non-partitioned libraries only. See “[Partition Screen Reference](#)” on page 332 for the screens used in managing capacity in partitioned libraries.

---



---

**Note** – Only the [Select Active Cells—Current Active Cells](#) screen is available on the local operator panel. The remaining screens can be accessed only from the standalone SL Console or the Web-launched SL Console.

---

Screen	Page
<a href="#">Select Active Cells &gt; Module Map</a>	246
<a href="#">Select Active Cells &gt; Select Active Cells</a>	248
<a href="#">Select Active Cells &gt; Select Active Cells—Confirm Apply</a>	254
<a href="#">Select Active Cells—View Reports—Cartridge Cell and Media Summary</a>	259
<a href="#">Select Active Cells—View Reports—Orphaned Cartridge Report</a>	262
<a href="#">Select Active Cells—Current Active Cells</a>	264

---

**Note** – The **Select Active Cells** screen, and all associated popups, give you a dynamic workspace to design active storage regions. All active cell information is automatically saved to the storage region workspace in SL Console memory and retained for the duration of your SL Console session. This allows you to make modifications and leave and return to the **Select Active Cells** screens any number of times without losing your changes.

---

**Caution** – Information in the SL Console active storage region workspace is saved to the library controller database only through the **Apply** button. If your SL Console session ends or you refresh the workspace data before you have committed your updates through the **Apply** button, you will lose any active storage region changes you have made through the **Select Active Cells** screens and all associated popups.

---

## Select Active Cells > Module Map

### Sample Screen

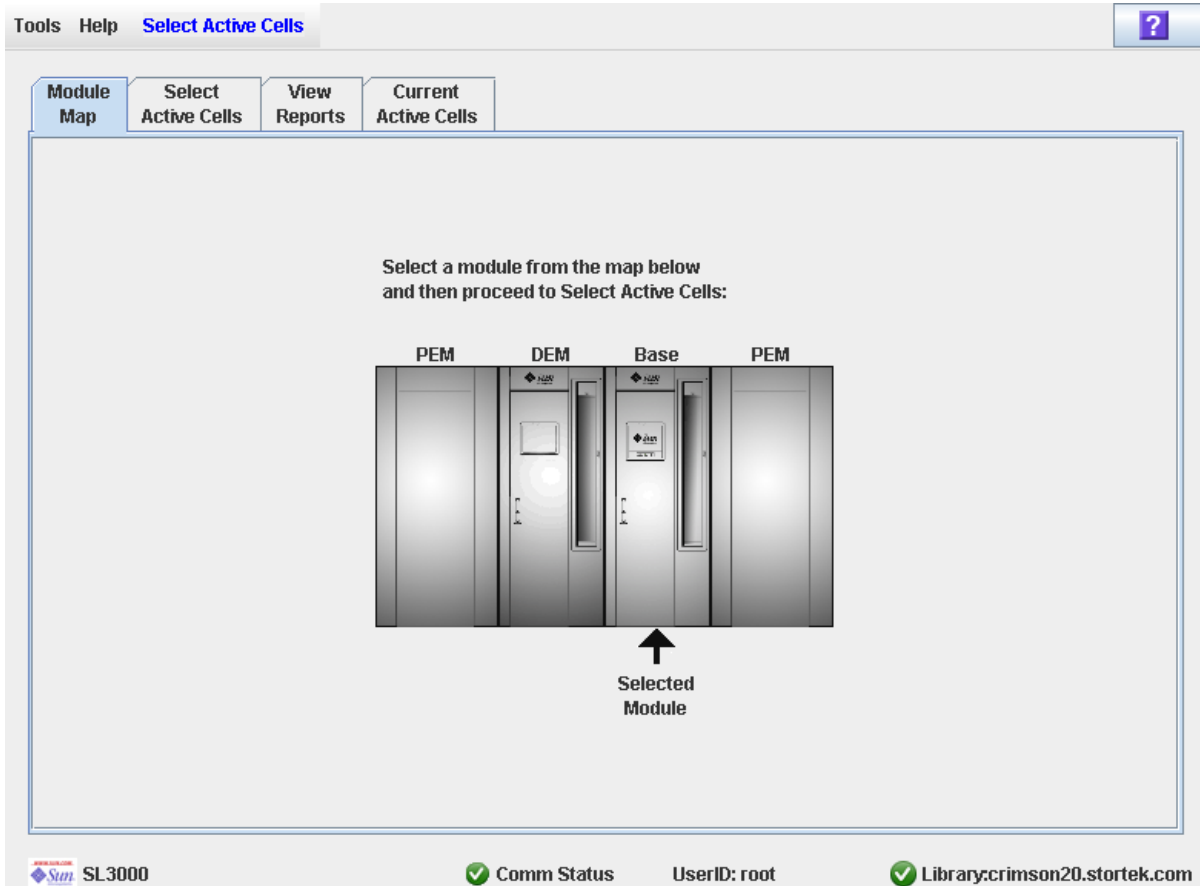

### Description

Allows you to select the library module for which you want to activate or de-activate cells for cartridge storage.

### Screen Fields

#### Select a module from the map below

The screen displays an illustration of the library's actual module configuration. This information is taken directly from the library controller database.

Click the module for which you want to select storage cells, then click the **Select Active Cells** tab.

## Buttons

### ? (Help)

Click to display online help for the screen.

### See Also

- [Select Active Cells > Select Active Cells](#)

## Select Active Cells > Select Active Cells

### Sample Screen

Tools Help **Select Active Cells** Apply Refresh ?

Module Map **Select Active Cells** View Reports Current Active Cells

Move Left Move Right

Select by: Cell

Add  Remove

Current Library Totals

Licensed Capacity: 1200  
Active Cells: 1200

Selection Totals

Selected Cells: 1462  
Unselected Cells: 0  
% Capacity Used: 100.00%

Interface Type  
FC-SCSI

Legend

- Not Accessible
- Inactive
- Active
- Selected
- No Activation Needed
- Cartridge

Front Wall Back Wall

Base Module 7

CAP

No Activation Needed  
Side(1) Column(2) Row(2)  
Cartridge : Empty

Drive Type : IbmUltrium4  
Drive Serial Number : 1310036636  
Drive Interface Type : Fibre

SL3000 Comm Status UserID: root Library:crimson20.stortek.com

### Description

**Note** – If you want to use the default active storage region configuration defined by the library controller, you do not need to use this screen.

Allows you to define active library storage regions by selecting the storage cells you want to activate or de-activate for use. This allows you to configure active storage cells so that cartridges are concentrated around the drives, and the ends of the library are left for future growth.

You can activate any number of cells up to the total licensed capacity of the library. Selected cells that cannot be activated due to licensed capacity limits will remain selected and will be activated automatically whenever additional licensed capacity is installed.

You can use any of the following methods to select storage cells (see [“Library Map” on page 251](#) for detailed instructions):

- Select individual cells or groups of cells
- Select an entire column within a library module
- Select a side within a library module (front or back)
- Select an entire library module
- Select all cells within the library

---

**Caution** – De-activating storage cells can result in orphaned cartridges and inaccessible data. See [“Orphaned Cartridges in Non-Partitioned Libraries”](#) on page 226 for details.

---



---

**Note** – You can select storage cells only; installed CAPs and tape drives are always active.

---



---

**Note** – The **Select Active Cells** screen, and all associated popups, give you a dynamic workspace to design active storage regions. All active cell information is automatically saved to the storage region workspace in SL Console memory and retained for the duration of your SL Console session. This allows you to make modifications and leave and return to the **Select Active Cells** screens any number of times without losing your changes.

---



---

**Caution** – Information in the SL Console active storage region workspace is saved to the library controller database only through the **Apply** button. If your SL Console session ends or you refresh the workspace data before you have committed your updates through the **Apply** button, you will lose any active storage region changes you have made through the **Select Active Cells** screens and all associated popups.

---

## Screen Fields

### Select by

Required.

Indicates the method you want to use for selecting storage cells to activate or deactivate. Options are:

- Cell – Select individual or rectangular groups of cells.
- Column – Select all cells within a column.
- Side – Select all cells within one side of a library module.
- Module – Select all cells within a library module.
- Library – Select all cells within the library.

---

**Note** – You must select either **Add** or **Remove**.

---

### Add

Required.

Indicates you want to add cells to the active storage region. You will only be able to click inactive cells on the library map.

**Remove**

Required.

Indicates you want to remove cells from the active storage region. You will only be able to click active or selected cells on the library map.

*Current Library Totals*

**Capacity**

Display only.

Total licensed storage capacity of the library.

**Active Cells**

Display only.

Total number of storage cells that have been activated for use in the library controller database. This cannot be greater than the licensed **Capacity**.

*Selection Totals*

**Selected Cells**

Display only.

Total number of selected and active cells. This can be greater than the licensed **Capacity**.

**Unselected Cells**

Display only.

Total number of de-selected and inactive cells.

---

**Note – Selected Cells + Unselected Cells = library physical capacity**

---

**% Capacity Used**

Display only.

Percentage of total licensed capacity that has been selected for use (cannot be greater than 100%). Calculated as:

$$\text{Selected Cells} / (\text{licensed}) \text{ Capacity}$$

**Interface Type**

Required.

Type of interface to be used for the library host connection. Options are:

- HLI
- FC-SCSI

The screen displays the value assigned previously. You can leave it as is or make changes.

---

**Note** – For additional details about modifying this field, see [“Change the Library Interface Type \(Non-Partitioned Libraries\)”](#) on page 111.

---

### *Legend*

Legend for the library map. The state of each library resource (storage cell, tape drive, or CAP cell) is indicated as follows:

- Not Accessible (white and x-ed out). Resource is not accessible to any host. Following are some possible reasons:
  - Storage cells have been configured for diagnostic cartridges.
  - Drive bay has no installed drive.
  - CAP has been configured for storage, not CAP operations.
- Inactive (white). Storage cell is not selected.
  - If the cell also has a “dog-eared” left corner, it is currently activated for use in the library controller database and you have selected this cell to be removed from the active storage region. The cell will be made inactive in the library controller database when you click the **Apply** button.
  - If the cell does not have a “dog-eared” left corner, it is currently inactive in the library controller database. There will be no change to the cell’s status in the library controller database when you click the **Apply** button.
- Active (“dog-eared” left corner). Indicates the status of the storage cell in the library controller database:
  - Cells with a “dog-eared” left corner are currently active.
  - Cells with no “dog-eared” left corner are currently inactive.
- Selected (purple). Storage cell is selected. Cells can be selected automatically by the library controller or manually by the user.
  - If the cell also has a “dog-eared” left corner, it is currently activated for use in the library controller database. There will be no change to the cell’s status in the library controller database when you click the **Apply** button.
  - If the cell does not have a “dog-eared” left corner, it is currently inactive in the library controller database and you have selected this cell to be added to the active storage region. When you click the **Apply** button, the cell will be made active in the library controller database, up to the total licensed capacity of the library. Purple cells that cannot be activated due to licensed capacity limits will remain purple and will be activated automatically whenever additional licensed capacity is installed.
- No Activation Needed (brown). Resource cannot be selected on this screen because it is active by default; applies to all CAP cells and tape drives.
- Cartridge (cartridge icon). Resource contains a tape cartridge.
- Drive slots with installed drives are outlined with a thick border. Empty drive slots have a narrow border.

### *Library Map*

Graphical representation of the current library configuration. Initial display for the current SL Console login session is from the library controller database, then the display reflects your modifications. The display includes the following information:

- Type of module currently displayed (base module, drive expansion module, access expansion module, parking expansion module.)
- Numeric module ID (1–12)
- Location of all resources (storage cells, tape drives, CAP cells) within the library

---

**Note** – Move the cursor over any resource to display a tooltip of detailed information about the cell or drive, whether it is active in the library controller database, whether it is currently selected on the screen, and the identity of any resident cartridge.

---

Use the library map to modify the boundaries of the active storage capacity areas. Depending on whether you have clicked the **Add** or **Remove** radio button, cells you click will be selected or de-selected.

Depending on your choice in the **Select by** field, you can perform any of the following actions.

- **Select by cell** – Select individual or groups of resources. Active storage cells do not need to be adjacent to one another.
  - To select an individual storage cell, double-click it.
  - To select a rectangular group of storage cells, click the cell at one corner of the rectangle, and then click the cell diagonally opposite.
- **Select by column** – Select an entire column within the module. Columns of active cells do not need to be adjacent to one another. Click any storage cell within the column you want to select.
- **Select by side** – Select all storage cells within an entire module side. Active sides do not need to be adjacent to one another. Click any storage cell within the side you want to select.
- **Select by module** – Select all storage cells within a module. Active modules do not need to be adjacent to one another. Click any storage cell within the module you want to select.
- **Select the library** – Select all storage cells in the library. Click any storage cell in the library.

## Buttons

### Move Left

Click to display the library module directly to the left of the one currently displayed. This button is grayed out if there is no module to the left.

### Move Right

Click to display the library module directly to the right of the one currently displayed. This button is grayed out if there is no module to the right.

### Apply

Click to update the library controller database with the current settings from the screen. The **Confirm Apply** popup appears, indicating whether there are any orphaned cartridges or other errors in the active storage region configuration.

---

**Note** – This button is grayed out if you have not made any changes to the **Select Active Cells** screen since the last update.

---



The status of the cells will be updated in the library controller database, as follows:

- White cells with a “dog-eared” left corner are made inactive.
- Purple cells without a “dog-eared” left corner are made active, up to the total licensed capacity of the library. Purple cells that cannot be activated due to licensed capacity limits will remain purple and will be activated automatically whenever additional licensed capacity is installed.
- All other cells are left unchanged.

#### **Refresh**

Click to refresh the screen with current data from the library controller database. All unapplied active storage region changes you have made during this SL Console login session will be discarded. The **Cell Selection Refresh** popup appears, prompting you to confirm the refresh.

#### **? (Help)**

Click to display online help for the screen.

#### **See Also**

- [Select Active Cells > Module Map](#)
- [Select Active Cells > Select Active Cells—Confirm Apply](#)
- [Select Active Cells—Current Active Cells](#)

## Select Active Cells > Select Active Cells—Confirm Apply

### Sample Screen

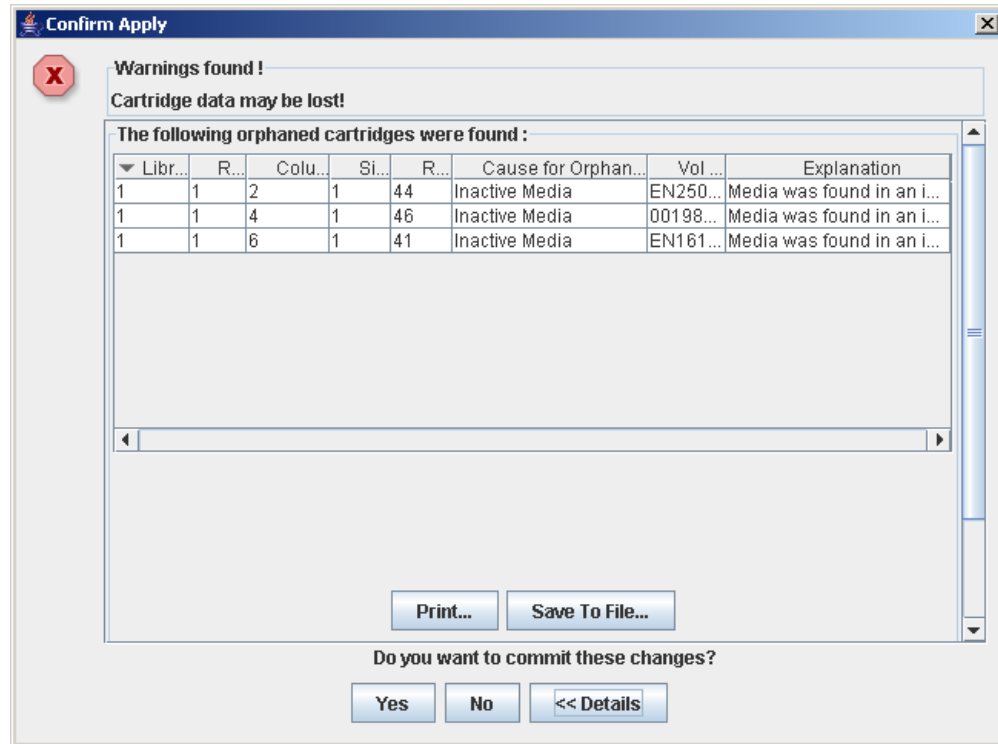

### Description

Displays a list of configuration errors in the defined active storage regions. This screen is a popup that appears when you click **Apply** on the [Select Active Cells > Select Active Cells](#) screen.

After viewing the error messages, you can commit all data from the **Select Active Cells** screen to the library controller database by clicking the **Yes** button.

---

**Caution** – Although changes to active capacity are not disruptive to library hosts, it is recommended that you make the library unavailable to other users before committing your active storage region changes. Because the SL Console does not validate storage region boundaries against the library controller database in real-time, configuration conflicts may arise if you change active storage region boundaries while other users are performing cartridge movements or library configuration changes. See [“Synchronizing the Display With the Controller Database” on page 36](#) for details.

---

Possible errors include:

- The library has orphaned cartridges. See [“Orphaned Cartridges in Partitioned Libraries” on page 273](#) for details.

- Storage cells have been removed from the library.

If any of these error conditions are present, the screen initially displays summary warning messages. You can view detailed messages by clicking the **Details** button.

It is recommended that you resolve all errors before committing the data to the library controller database.

Optionally, you can print the screen data or save it to a comma-separated file.

## Screen Fields

### Warnings found

Display only.

Summary error messages regarding the storage region configuration.

### Column

Display only.

Column number where the orphaned cartridge is located. Column location is referenced from the left edge of the Base Module. "+1" is to the right; "-1" is to the left.

### Side

Display only.

Module side where the orphaned cartridge is located. "1" is the back wall; "2" is the front wall.

### Row

Display only.

Row number where the orphaned cartridge is located. Rows are numbered consecutively from the top down, with row "1" at the top.

### Cause for Orphaned State

Display only.

Reason why the cartridge has been identified as orphaned. Options include:

- Just Activated
- Inactive Media

### Vol Ser

Display only.

Volume serial number (VOLID) of the orphaned cartridge.

### Explanation

Display only.

Explanation of why the cartridge is orphaned.

Some possible options are:

- Media was found in an inactive cell.
- Inactive cell with media was just activated.

Buttons

---

**Note** – To display the **Print** and **Save to File** buttons, you may need to scroll down within the inner window.

---

**Print**

Click to print the report on a selected printer.

**Save to File**

Click to save the report to a designated comma-separated text file (.csv extension). Comma-separated files can be opened by a variety of spreadsheet and database programs.

**Yes**

Click to confirm that you want to update the library controller database with the current settings from the **Select Active Cells**. The status of the cells are updated in the library controller database, as follows:

- White cells with a “dog-eared” left corner are made inactive.
- Purple cells without a “dog-eared” left corner are made active, up to the total licensed capacity of the library. Purple cells that cannot be activated due to licensed capacity limits will remain purple and will be activated automatically whenever additional licensed capacity is installed.
- All other cells are left unchanged.

**No**

Click to cancel the update. The library controller database is not updated, but the current settings on the **Select Active Cells** are retained.

**Details**

Click to toggle between the expanded and collapsed views of the warning message display.

**See Also**

- [Select Active Cells > Select Active Cells](#)

# Select Active Cells—View Reports

## Sample Screen

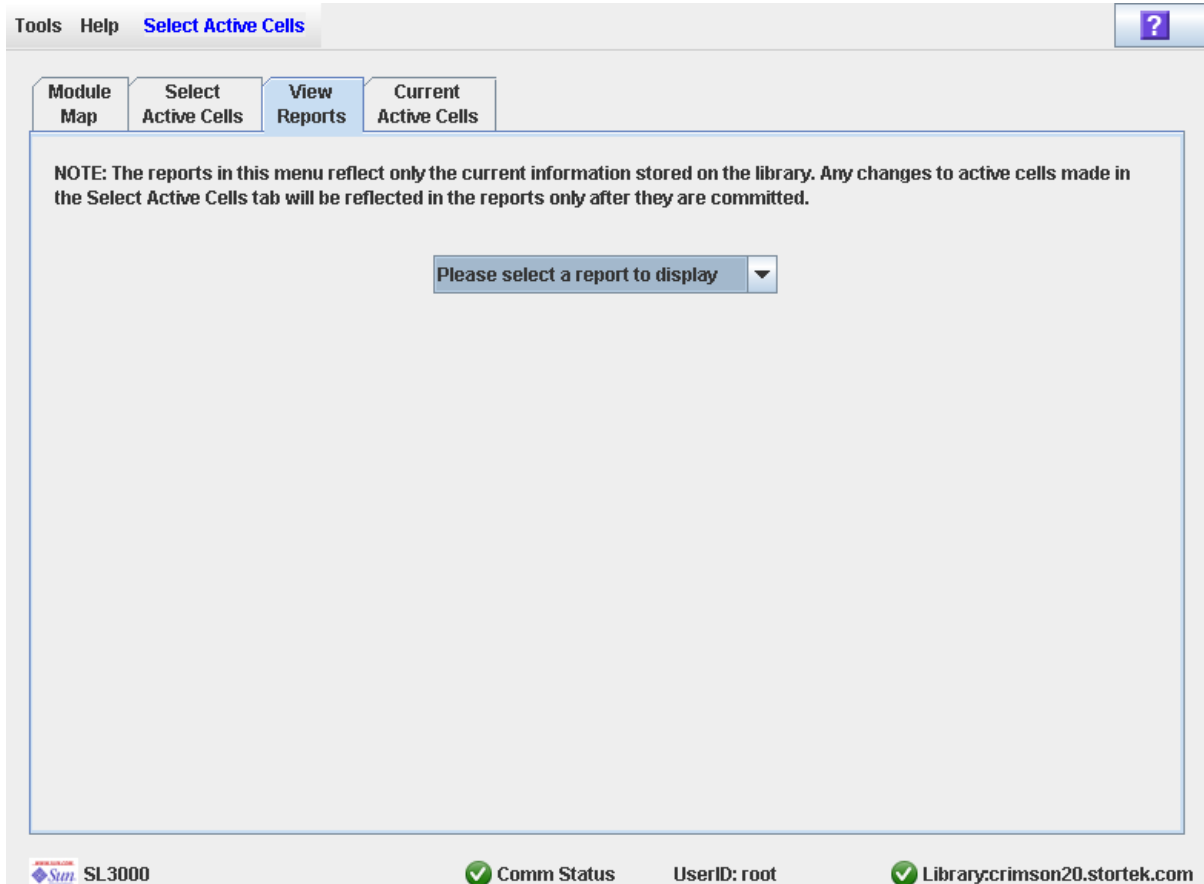

## Description

Allows you to select one of the following active storage region reports:

- Cartridge Cell and Media Summary
- Orphaned Cartridge Report

---

**Note** – The active storage region reports display data saved to the library controller database. If you have made changes to the active storage region configuration without committing the changes through the **Apply** button, the data in these reports will differ from data shown on the **Select Active Cells** screen.

---

## Screen Fields

**Please select a report to display**

Required.

Click the report you want to display. The drop-down menu lists all available active storage region reports.

## Buttons

### Apply

Click to update the library controller database with the current settings from the screen. The **Confirm Apply** popup appears, indicating whether there are any orphaned cartridges or other errors in the active storage region configuration.

---

**Note** – This button is grayed out if you have not made any changes to the **Select Active Cells** screen since the last update.

---

### Refresh

Click to refresh the screen with current data from the library controller database. All unapplied active storage region changes you have made during this SL Console login session will be discarded. The **Cell Selection Refresh** popup appears, prompting you to confirm the refresh.

### ? (Help)

Click to display online help for the screen.

## See Also

- [Select Active Cells > Select Active Cells](#)
- [Select Active Cells—View Reports—Cartridge Cell and Media Summary](#)
- [Select Active Cells—View Reports—Orphaned Cartridge Report](#)

# Select Active Cells—View Reports—Cartridge Cell and Media Summary

## Sample Screen

Tools Help **Select Active Cells** ?

Module Map **Select Active Cells** **View Reports** Current Active Cells

NOTE: The reports in this menu reflect only the current information stored on the library. Any changes to active cells made in the Select Active Cells tab will be reflected in the reports only after they are committed.

Cartridge Cell and Media Summary ▼

Cell and Media Summary as of 3/7/08 11:03 AM

▼ Library	Rail	Column	Side	Row	Element Type	Vol Ser	Cell Status
1	1	-9	1	1	CELL		Active
1	1	-9	1	2	CELL		Active
1	1	-9	1	3	CELL		Active
1	1	-9	1	4	CELL		Active
1	1	-9	1	5	CELL		Active
1	1	-9	1	6	CELL		Active
1	1	-9	1	7	CELL		Active
1	1	-9	1	8	CELL		Active
1	1	-9	1	9	CELL		Active

Print... Save To File...

SL3000 ✓ Comm Status UserID: root ✓ Library:crimson20.stortek.com

## Description

Displays detailed information about all library resources (storage cells, tape drives, and CAP cells) and any stored cartridges.

---

**Note** – The active storage region reports display data saved to the library controller database. If you have made changes to the active storage region configuration without committing the changes to the library controller, the data in these reports will differ from data shown on **Select Active Cells** screen.

---

You can modify the layout and display of this screen. See [“Modifying the Screen Layout” on page 36](#) for details.

Optionally, you can print the screen data or save it to a comma-separated file.

## Screen Fields

### Library

Display only.

Library number where the library resource is located. This is always "1".

### Rail

Display only.

Rail number where the library resource is located. This is always "1".

### Column

Display only.

Column number where the library resource is located. Column location is referenced from the left edge of the Base Module. "+1" is to the right; "-1" is to the left.

### Side

Display only.

Module side where the library resource is located. "1" is the back wall; "2" is the front wall.

### Row

Display only.

Row number where the library resource is located. Rows are numbered consecutively from the top down, with row "1" at the top.

### Element Type

Display only.

Type of library resource. Options are:

- CAP
- CELL
- DRIVE

### Vol Ser

Display only.

Volume serial number (VOLID) of the cartridge resident in the library resource, if applicable.

### Cell Status

Display only.

Capacity status of the library resource. Applies to storage cells only. Options are:

- Active – Cell is activated for use and can be used for cartridge storage.
- Inactive – Cell is not activated for use and cannot be used for cartridge storage.

## Buttons

### Print

Click to print the report on a selected printer.



**Save to File**

Click to save the report to a designated comma-separated text file (.csv extension). Comma-separated files can be opened by a variety of spreadsheet and database programs.

**? (Help)**

Click to display online help for the screen.

**See Also**

- [Select Active Cells—View Reports](#)
- [Select Active Cells—View Reports—Orphaned Cartridge Report](#)

## Select Active Cells—View Reports—Orphaned Cartridge Report

### Sample Screen

Tools Help **Select Active Cells** ?

Module Map **Select Active Cells** **View Reports** Current Active Cells

NOTE: The reports in this menu reflect only the current information stored on the library. Any changes to active cells made in the Select Active Cells tab will be reflected in the reports only after they are committed.

Orphaned Cartridge Report ▼

Library	Rail	Column	Side	Row	Vol Ser	Explanation
1	1	8	2	31	STK06412	Inactive cell wit...
1	1	9	2	3	LT3138L3	Inactive cell wit...

Print... Save To File...

SL3000 ✓ Comm Status UserID: root ✓ Library:crimson20.stortek.com

### Description

Displays the locations and volume serial numbers (VOLIDs) of all orphaned cartridges in the library. Also identifies why the cartridge is orphaned.

---

**Note** – The active storage region reports display data saved to the library controller database. If you have made changes to the active storage region configuration without committing the changes to the library controller, the data in these reports will differ from data shown on **Select Active Cells** screen.

---

You can modify the layout and display of this screen. See [“Modifying the Screen Layout” on page 36](#) for details.

Optionally, you can print the screen data or save it to a comma-separated file.

## Screen Fields

### Column

Display only.

Column number where the orphaned cartridge is located. Column location is referenced from the left edge of the Base Module. "+1" is to the right; "-1" is to the left.

### Side

Display only.

Module side where the orphaned cartridge is located. "1" is the back wall; "2" is the front wall.

### Row

Display only.

Row number where the orphaned cartridge is located. Rows are numbered consecutively from the top down, with row "1" at the top.

### Vol Ser

Display only.

Volume serial number (VOLID) of the orphaned cartridge.

### Explanation

Display only.

Explanation of why the cartridge is orphaned.

Some possible options are:

- Media was found in an inactive cell.
- Inactive cell with media was just activated.

## Buttons

### Print

Click to print the report on a selected printer.

### Save

Click to save the report to a designated comma-separated text file (.csv extension). Comma-separated files can be opened by a variety of spreadsheet and database programs.

### ? (Help)

Click to display online help for the screen.

## See Also

- [Select Active Cells—View Reports](#)
- [Select Active Cells—View Reports—Orphaned Cartridge Report](#)

## Select Active Cells—Current Active Cells

### Sample Screen

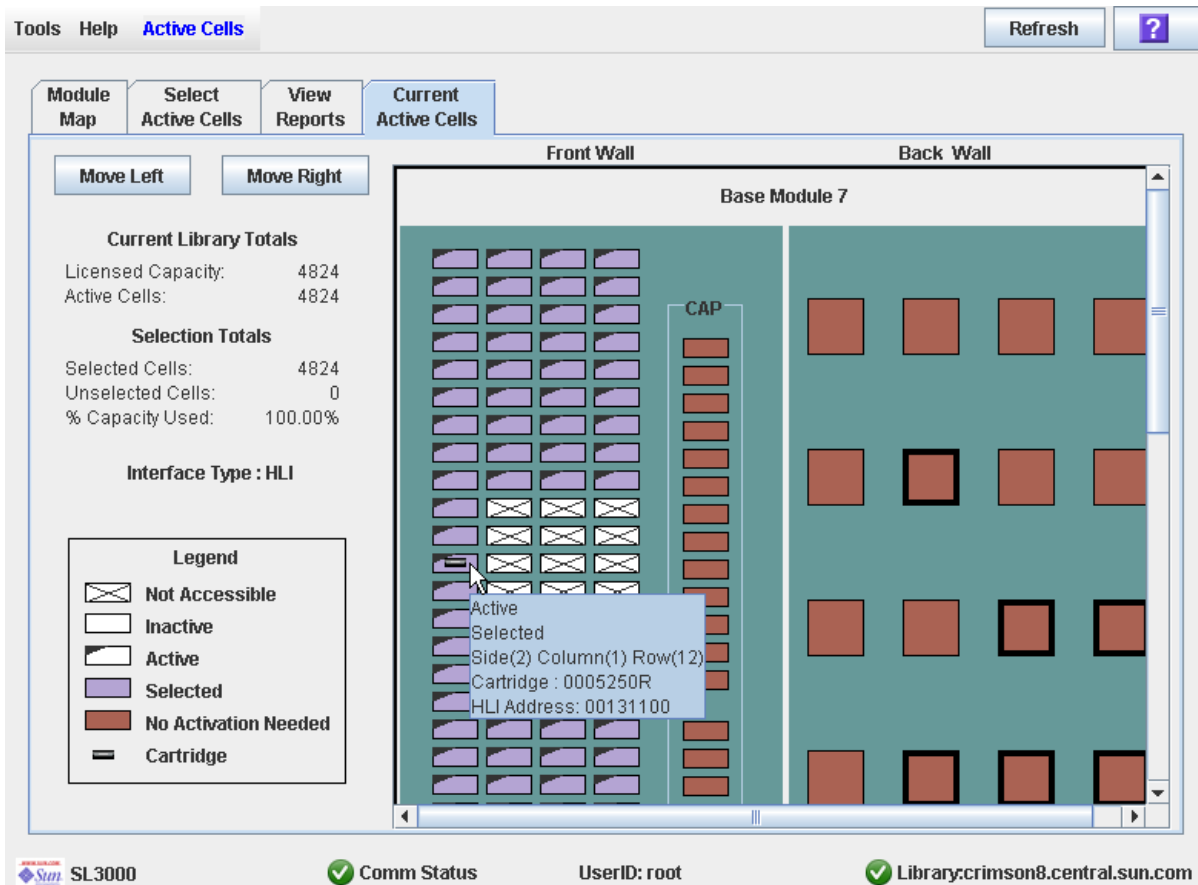

### Description

Displays current active library storage regions. Shows which storage cells are currently active, inactive, or selected for activation.

This is the only **Select Active Cells** screen that is available on the local operator panel.

---

**Note** – This screen is display only.

---

### Screen Fields

For detailed descriptions of the screen fields, see [“Select Active Cells > Select Active Cells”](#) on page 248.

## Buttons

### **Refresh**

Click to refresh the display with current data from the library controller database.

### **? (Help)**

Click to display online help for the screen.

## See Also

- [Select Active Cells > Select Active Cells](#)



# 6

## Library Partitioning

---

**Note** – Library partitioning is a licensed feature which must be installed through the SL3000 licensing utility. See [Chapter 4, “Licensing”](#) for details.

---

Library partitioning allows sections of the SL3000 library to be assigned for exclusive use by specified hosts. For example, you can configure one group of storage cells and drives to be used only for Veritas operations, and another group only for Tivoli operations. This allows you to configure an SL3000 library for applications running on multiple operating systems.

---

## Partitioning Features and Restrictions

This section describes important features and restrictions of library partitioning that will help you to configure and use partitioning in your SL3000 library.

- You can configure up to eight partitions within an SL3000 library.
- A partition can be as small as a single storage cell or tape drive, or a whole rotational or AEM CAP. Cells and drives within a partition do not need to be adjacent.
- Storage cells and tape drives allocated to a partition can be used only by the hosts assigned to that partition. Hosts assigned to other partitions cannot access the contents of these cells and drives. See “Storage Cells and Drives” on page 273 for details.
- Storage cells and drives not allocated to any partition cannot be accessed by any hosts. For example, you might leave an area of cells unallocated, in preparation for future partitioning.
- Host-partition connections can use either the FC-SCSI or HLI (TCP/IP) interface.
- Whole rotational or AEM CAPs can be allocated for exclusive use by one partition, or they can be shared by multiple partitions. See “Partitions and Rotational and AEM CAPs” on page 275 for details.
- CAPs can only be shared by partitions with the same host interface type. That is, FC-SCSI and HLI partitions cannot both share the same CAP.
- With the non-disruptive partitioning (NDP) feature, there is minimal host disruption whenever resources are allocated to a partition, and changes made to one partition do not impact other partitions or their host connections. See “[Non-Disruptive Partitioning](#)” on page 280 for details.

## Enabling and Disabling Partitioning

In order for you to use partitions in a library, the partitioning feature must be installed through the licensing utility. See [Chapter 4, "Licensing" on page 201](#) for details.

A library with partitioning enabled can be in either of the following states:

- Partitioned – The library has at least one user-defined partition with a valid partition ID.
- Non-partitioned – The library has no user-defined partitions. A non-partitioned library behaves in the same manner as a library that does not have partitioning enabled; that is all active storage cells, drives, and rotational and AEM CAPs are accessible to all hosts.

To disable partitioning on a library, you must first delete all partitions. The library state will then change to "non-partitioned."

---

## Partition Planning

The partitioning feature offers great flexibility in the use of your library. It also requires careful planning, a thorough knowledge of library wall and storage cell mapping, and expertise in configuring and administering host software applications. There must be clear communication among all parties involved, including system programmers and administrators, library operators, and your Sun service representative.

Before creating partitions, you must plan the storage area that is needed for resident tape cartridges and anticipate the number of required free cells. You must understand the boundaries of each partition and the host ownership relationships. You must verify that all tape drives and cartridges have been moved to the proper locations, according to the planned assignments.

## Installing the Partitioning Feature

The following special considerations apply after you successfully install the Partitioning feature on a previously non-partitioned library.

- You can begin creating partitions immediately; you do not need to reboot the library first.
- Until you create at least one partition, the library remains in a non-partitioned state; that is all licensed storage cells, drives, and rotational and AEM CAPs are accessible to all hosts.

## Allocated Storage Capacity

In partitioned libraries, the total number of storage cells allocated to all library partitions cannot exceed the licensed capacity of the library.



In partitioned libraries, there is no default active storage region. You must explicitly assign storage cells to partitions, thereby configuring the active storage regions for each partition. See [“Partitioning Process” on page 283](#) for details.

When assigning cartridges to storage cells, the library controller applies the predefined cell selection rules separately to each partition. See [“Cell Activation Rules” on page 225](#) for details.

## Partition Configurations

You must use the standalone SL Console or Web-launched SL Console to configure library partitions; the partitioning screens are not available on the local operator panel.

To configure a partition, you must define the following information:

- [Partition Summary Information](#)
- [Host-Partition Connections](#)
- [Partition Boundaries](#)

For detailed instructions on defining library partitions, see [“Partitioning Process” on page 283](#).

### Partition Summary Information

Partition summary information includes the partition ID, name, and host-partition connection type (HLI or FC-SCSI). Partition IDs must be unique and can range from 1–8.

### Host-Partition Connections

Host-partition connections identify the hosts that are able to access a partition. Each partition appears to the host as a separate library. A host can control one or more partitions. In addition, it is possible for more than one host to control a single FC-SCSI partition, but it is recommended that you exercise caution in implementing this configuration, as some host applications may not allow for resource sharing.

#### *HLI Host-Partition Connections*

An HLI (Host Library Interface) partition can have up to 16 assigned hosts. You define the HLI host-partition connection configuration through the library management software (ACSL or HSC). Therefore there are no SL Console screens to display or maintain this information. See the appropriate tape management software documentation for details.

#### *FC-SCSI Host-Partition Connections*

An FC-SCSI partition can have one or more host-partition connections. The host-partition connection configuration is user-defined and consists of the following information:

- World Wide Port Name of the FC-SCSI host bus adapter

- Port number of the library Fibre Channel card
- Logical unit number (LUN) of the partition on the host

See [“Configure a Host-Partition Connection” on page 289](#) for detailed instructions on defining this information.

## Partition Boundaries

Partition boundaries identify the storage cells, drives, and rotational and AEM CAPs that are part of each partition. Only unallocated cells can be added to a partition, and only allocated cells can be removed.

You can define partition boundaries in any of the following ways:

- Select individual cells or rectangular groups of cells to add or remove from a partition. Cells or cell groups do not have to be contiguous.
- Select a module column to add or remove from a partition. Columns do not have to be contiguous.
- Select an entire module side (front or back) to add or remove from a partition. Sides do not have to be contiguous.
- Select an entire module to add or remove from a partition. Modules do not have to be contiguous.

---

**Note** – It is possible to have partitions with no allocated resources.

---

---

# Partitions and Library Resources

## Library Resource Addresses

Resource addresses uniquely identify each resource (storage cells, drives, and rotational and AEM CAPs) within the library. The SL3000 library and attached hosts use the following addressing schemes:

- [Library Internal Address](#)
- [Host FC-SCSI Element Address](#)
- [HLI-PRC Address](#)

Each partition appears to a host as a separate library; this is reflected in the partition address.

## Library Internal Address

The library internal address is used by the SL3000 library controller and the SL Console device tree to identify the physical location of each resource. The addressing scheme used by the SL3000 is a five-digit, comma-separated value, specifying the library, rail, column, side, and row, as viewed from the front of the library, facing the drive bays.

The format of the SL3000 library internal address is  $l,r,c,s,w$  where:

- $l$  = library or partition number; this value is always "1".
- $r$  = rail number; this value is always "1".
- $c$  = column number. Column numbering is referenced from the left edge of the Base Module, as you face the inside back wall, as follows:
  - Numbering is static, allowing modules to be added without renumbering existing columns.
  - Columns within and to the right of the Base Module are numbered positively (+), in ascending sequence from left to right.
  - Columns to the left of the Base Module are numbered negatively (-), in descending sequence from right to left.
  - Base Module panels are always "1" to "6".
  - DEM panels (if present) are always "-1" to "-6".
  - If there is no DEM and a CEM is to the left of the Base Module, then columns "-1" to "-6" are skipped and the CEM is assigned columns "-7" to "-12".
  - CEM columns to the right of the Base Module start with "7".
  - Left AEM columns are always numbered "-33" to "-31". Right AEM columns are always "31" to "33". In other words, AEM columns are numbered as if a DEM and four CEMS are installed to the left, and four CEMs are installed to the right, of the Base Module.
- $s$  = side. Back wall = "1"; front wall = "2".
- $w$  = row number. Numbered consecutively from the top, down. Valid values are "1" to "52", with row "1" at the top.

## Host FC-SCSI Element Address

The FC-SCSI element address is used by hosts with an FC-SCSI connection to the SL3000 library to uniquely identify each library resource available to the host.

FC-SCSI element numbering uses a single integer to identify each library resource. FC-SCSI element numbering within partitioned libraries is continuous for each partition, even if cell locations for the partition are not adjacent. FC-SCSI element addresses for a partition start at the lowest module, row, and column within the partition, then proceed by row until the end of the column, then increment by column until the end of the module.

When additional resources are allocated to an existing FC-SCSI partition, the original resources are not renumbered. This helps to minimize disruption to the FC-SCSI host.

### *FC-SCSI Element Address Examples*

If a library's base and storage expansion modules are allocated to Partition 1 and the drive module is allocated to Partition 2, FC-SCSI element numbering is as follows:

- Numbering for Partition 1 begins at the first available storage cell in the Base Module and continues through the last available cell in the storage module cell.
- Numbering for Partition 2 begins with the first available storage cell in the drive module PRC Address and ends with the last available cell in that module.

## HLI-PRC Address

The HLI-PRC (Host Library Interface-Panel, Row, Column) address is used by hosts with an HLI connection to the SL3000 library, including ACSLS and HSC. The HLI-PRC address uniquely identifies each library resource accessible to the host and is assigned by the host software.

The HLI-PRC address is an eight-digit value specifying the library, panel, row, and column where the resource is located. The format is *ll:pp:rr:cc*, where:

- *ll* = Library number; this value is always "00".
- *pp* = Panel number. Numbering is relative to the Base Module, as follows:
  - Base Module panels are always "12" and "13".
  - Modules to the left of the Base Module are numbered in descending sequence, starting with "11"; modules to the right are numbered in ascending sequence, starting with "14".
  - Rear walls are assigned even numbers; front walls are assigned odd numbers.
  - DEM panels (if present) are always "10" and "11".
  - If there is no DEM and a CEM is to the left of the Base Module, then panels "10" and "11" are skipped and the CEM is assigned panels "8" and "9". This allows you to add a DEM to the left of the Base Module at a later date without renumbering modules.
  - For AEM panel numbering, see ["HLI CAP numbering – rotational and AEM CAPs" on page 272](#).
- *rr* = Row number within the panel. Numbered consecutively from the top, down. Valid values are 0–51, with row 0 at the top.
- *cc* = Column number within the panel. Numbered consecutively from left to right, starting at the front of the module. Each panel has a maximum of six columns; therefore, valid column values are 0–5.

### *HLI CAP numbering – rotational and AEM CAPs*

---

**Note** – HSC displays HLI-PRC addresses in hexadecimal notation. Therefore, panels 10, 11, and 12 are displayed as "0A", "0B", and "0C" respectively. ACSLS and the SL Console display HLI-PRC addresses in decimal notation.

---

Library CAP numbers are assigned by module, from left to right:

- Base Module CAP = 6
- DEM CAP = 5
- Rotational CAPs in CEMs to the left of the Base Module = 1–4
- Rotational CAPs in CEMs to the right of the Base Module = 7–10
- AEM CAP to the left of the Base Module = 0
- AEM CAP to the right of the Base Module = 11

Rotational CAPs contain a single column of cells with 26 rows; cells are numbered 0–25.

The AEM contains a bulk load CAP with 234 cells arranged in six columns. Column numbering starts at the rear wall and runs left to right (columns 0–2); then proceeds to the front wall and runs left to right (columns 3–5).

## Storage Cells and Drives

All storage cells, tape drives, and cartridges allocated to a partition are owned exclusively by the assigned host and cannot be accessed by other hosts. For example, if a group of tape drives is allocated to a partition, only the host assigned to that partition can use those drives.

Storage cells and drives that are not allocated to any partition cannot be accessed at all. For example, you can leave an area of cells unallocated in preparation for a planned future partition.

On the SL Console screens and reports, storage cells and drives appear in any of the following states:

- Allocated – Assigned to the current partition.
- Unallocated (or Unassigned) – Not assigned to any partition; available to be assigned to any current partition.
- Unavailable – Assigned to another partition.
- Not accessible – Not available for host operations; for example, cells reserved for diagnostic cartridges, cells that are physically blocked, and cells that are inactive.

---

**Note** – TallBots are shared resources and cannot be allocated exclusively to a partition.

---

To display partition assignments for storage cells and drives, see [“Partitions—Reports—Cartridge Cell and Media Summary”](#) on page 382.

## Orphaned Cartridges in Partitioned Libraries

---

**Note** – For a discussion of orphaned cartridges in non-partitioned libraries, see [“Orphaned Cartridges in Non-Partitioned Libraries”](#) on page 226.

---

In partitioned libraries, an orphaned cartridge is a cartridge located in an unallocated cell or drive (that is, a cell or drive not allocated to any defined partition).

---

**Caution** – If a host encounters an orphaned cartridge it might treat the cartridge as scratch and overwrite the data. Therefore, it is very important to disposition orphaned cartridges properly.

---

A cartridge can become orphaned for a variety of reasons. Following are some possible causes:

- Partition boundaries have changed.
- A partition has been deleted.

- The cartridge has been moved to an unallocated or inaccessible cell through manual intervention.

If the SL Console identifies an orphaned cartridge, it displays a warning message. You can then use the following tools to help you resolve and disposition the orphaned cartridge:

- Generate a report of orphaned cartridges.
- Perform an audit of the library.
- Perform a recovery move on a cartridge.

For detailed instructions on checking for and resolving orphaned cartridges, see the following procedures:

- [“Verify Partition Configurations” on page 296](#)
- [“Resolve Orphaned Cartridges” on page 299](#)
- [“Commit Partition Configuration Changes” on page 300](#)

---

## Partitions and Rotational and AEM CAPs

---

**Note** – AEM CAPs are subject to the same partitioning rules and restrictions as rotational CAPs. Throughout this section, the term “CAP” refers to both types of CAPs.

---



---

**Note** – The SL3000 does not support common CAPs, split CAPs, or the allocation of individual CAP cells to a partition. These features are available for the SL500 only.

---

When configuring CAPs, you must plan carefully for anticipated CAP usage. A partition can only use the CAPs explicitly allocated to it. There is no “common” CAP in the SL3000.

When you allocate a CAP to a partition, all cells in the CAP are allocated as a whole. It is not possible to allocate or de-allocate individual cells within a CAP. There is no “split” CAP in the SL3000.

### Using CAPS in a Partitioned Library

A rotational or AEM CAP is a shared library resource – that is, it can be used by all partitions in the library. A CAP can be used by only one partition at a time, however. While a partition is using a CAP for enters or ejects, the CAP is reserved to that partition and unavailable to all others.

In order for a partition to reserve a CAP, all of the following conditions must be met:

- The CAP must be available – that is, not reserved by any other partition.
- The CAP must be empty.
- The CAP must be closed and locked.

For additional details, see [“CAP “Ownership”” on page 276](#).

### CAP Allocations

All CAPs in a partitioned library are unallocated by default. You allocate CAPs to partitions through the following screens:

- [“Partitions—Design \(Step 3b\)” on page 356](#), for Base, Drive, and CEM modules
- [“Partitions—Design \(Step 3b\) – AEMs Only” on page 362](#), for AEM modules

CAP allocations can take either of the following forms:

- Dedicated – The CAP is allocated for the exclusive use of one partition.
- Shared – The CAP is allocated for the use of more than one specified partition. See [“Shared CAPs”](#) for details.

Once a CAP is allocated, it becomes either an FC-SCSI CAP or an HLI CAP, depending on the host interface type of the first partition to which it is allocated. For example, if you allocate a previously unallocated CAP to a partition with an FC-SCSI interface, the CAP becomes an FC-SCSI CAP. Subsequent allocations of the CAP can be to other

FC-SCSI partitions only. To change the CAP from FC-SCSI to HLI, you must first de-allocate the CAP from all FC-SCSI partitions, and then allocate the CAP to an HLI partition.

---

**Note** – CAP allocations are not required; it is possible to have partitions with no allocated CAP.

---

---

**Note** – Because FC-SCSI host applications typically do not use CAP reservations, it is recommended that you dedicate at least one CAP to each FC-SCSI partition whenever possible. This allows each partition to operate independently from the others and allows you to avoid the resource contention issues that can arise through shared CAPs.

---

## Shared CAPs

Because a library can have more partitions than CAPs, it may be necessary to share CAPs among partitions. Only partitions with the same host interface type can share a CAP. For example, any number of FC-SCSI partitions can share a group of one or more CAPs, and any number of HLI partitions can share a different group of CAPs, but HLI and FC-SCSI partitions cannot both share any of the same CAPs.

For ease of management, it is recommended that you keep shared CAP groupings together for all partitions they are allocated to. For example, if you allocate CAPs A and B to one partition, and another partition also needs access to A or B, you should allocate both CAPs, not just one of them, to the second partition.

---

**Note** – You must carefully manage shared CAP usage among FC-SCSI hosts in order to avoid contention. See [“CAP “Ownership”” on page 276](#) for details.

---

## CAP Auto Enter Mode

CAP auto enter mode allows a library operator to open a CAP and initiate an enter operation without issuing an explicit enter request and without an explicit reservation from a host application. Auto enter mode is available for CAPs that have been dedicated to a partition. CAPs in auto enter mode are left unlocked.

Auto enter mode is managed by the host applications. See the appropriate tape management software documentation for details.

## CAP “Ownership”

A CAP can be used by only one partition at a time for enters and ejects. A partition can take ownership of a CAP in any of the following ways:

- The CAP is dedicated to one partition. In this case the partition always has exclusive ownership of the CAP.



- A host application reserves the CAP prior to an enter or eject operation. This typically applies to HLI host applications only. See [“CAP Reservations” on page 278](#) for details.
- The user explicitly associates the partition to the CAP. This applies to shared FC-SCSI CAPs only. See [“Shared FC-SCSI CAP Associations” on page 279](#) for details.
- A partition places a cartridge in the CAP. If none of the conditions above apply, the first partition to place a cartridge in the CAP as part of an export operation takes ownership of the CAP until the export is completed and the CAP is closed and empty.

While a partition has ownership of a CAP, the CAP is reserved exclusively to that partition and unavailable to all others. The library sends “CAP opened” and “CAP closed” messages only to the host holding the reservation.

For HLI CAPs only, when a host attempts to reserve a CAP already reserved by another partition, the library sends a message to the requesting host identifying the partition ID and host ID holding the reservation.

## CAP States

A CAP must be unlocked in order for you to open it to insert or remove cartridges. When a CAP is unlocked, the light on the CAP button is turned on.

When you close a CAP, the TallBot performs an audit to determine whether there are cartridges present. During the audit the CAP is locked and the light on the CAP button is turned off. Once the audit is completed, the CAP is returned to its default state.

The following table describes the default states of the various types of CAPs within a partitioned library.

Type of CAP	Default State	Default CAP Button Light Condition	Comment
HLI – dedicated or shared	Locked	Off	Host reservation unlocks the CAP and turns the light on. See <a href="#">“CAP Reservations” on page 278</a> for details.
HLI – auto enter mode	Unlocked	On	
FC-SCSI – dedicated	Unlocked	On	
FC-SCSI – shared	Locked	Off	Partition-CAP association unlocks the CAP and turns the light on. See <a href="#">“Shared FC-SCSI CAP Associations” on page 279</a> for details.

## CAP Reservations

Both FC-SCSI and HLI hosts can make use of CAP reservations. CAP reservations give a partition exclusive ownership of a shared CAP for the duration of an enter or eject operation. When the operation is finished, the host application must release the reservation to make the CAP available to other partitions sharing the CAP. No other partitions can access the CAP until the first one has terminated the operation and released the reservation.

For a partition to reserve a CAP, the CAP must be unreserved (applies to shared CAPs only), empty, and closed.

### HLI CAP Reservations

HLI host applications use a strict reservation scheme to manage CAP usage among host clients, and therefore always reserve a CAP before unlocking it or moving a cartridge to it. When an HLI host application attempts to reserve a CAP already reserved by another partition, the library controller sends a message to the requesting host identifying the partition ID and host ID holding the reservation.

#### *Releasing CAP Reservations*

In normal operations, a CAP reservation for an ACSLS or HSC host is released in the following ways:

- Enter operations – After all cartridges have been successfully entered into the library, the host explicitly terminates the enter command. The library controller releases the CAP after verifying that the CAP is closed and empty.
- Eject operations – After all cartridges have been successfully ejected, the host automatically terminates the eject operation. The library controller releases the CAP after verifying that the CAP is closed and empty.

If for some reason a CAP reservation is not released as described above, the CAP will be unavailable to all other partitions, and cartridges belonging to the first partition may remain in the CAP. In this case, it is recommended that you terminate the enter or eject from the host holding the reservation. This ensures a normal release of the CAP reservation.

---

**Note** – See the ACSLS or HSC documentation for details about terminating enters and ejects.

---

#### *Overriding CAP Reservations*

In some cases, you may not be able to access the host holding a reservation and therefore cannot perform a normal release of the CAP. This may be because the host has terminated or because you lack physical access or security authorization to issue commands to the host. In these cases, you can override (unreserve) the CAP reservation manually. See [“Override a CAP Reservation” on page 329](#) for the detailed procedure.

---

**Note** – Use extreme care when using the SL Console to override a CAP reservation. If you do not complete the procedure, the CAP could be left unavailable to all partitions, and/or cartridges assigned to one partition could be entered into another partition.

---

---

**Note** – You can use the SL Console to override a CAP reservation only in a partitioned library. If a library is not partitioned, CAP reservations must always be released through ACSLS or HSC.

---

## FC-SCSI CAP Reservations

Most FC-SCSI host applications do not use CAP reservations. FC-SCSI host applications typically assume sole ownership of a CAP and therefore do not coordinate CAP sharing well. To avoid contention among partitions for a shared CAP, you can manually associate a partition to a CAP. See [“Shared FC-SCSI CAP Associations” on page 279](#) for details.

## Shared FC-SCSI CAP Associations

If a FC-SCSI partition shares CAPs with other partitions, it is recommended that you manually associate the partition to its CAPs prior to initiating an enter or eject operation. See [“Associate an FC-SCSI Partition to Its Shared CAPs” on page 324](#) for the detailed procedure.

A partition-CAP association gives a partition exclusive ownership of its shared CAPs, similar to a CAP reservation. This ensures that cartridges are always entered into the correct partition and prevents other partitions from taking ownership of a shared CAP that is already in use.

The following rules apply when making partition-CAP associations:

- You can associate only one partition at a time to a CAP.
- Selecting a partition causes all its allocated CAPs to be associated to it at once; you cannot select individual CAPs to be associated to the partition.
- You can select multiple partitions at once, as long as the selected partitions do not share any CAPs with one another.
- Partition-CAP associations remain active until you explicitly remove them; the associations are not automatically removed when the enter or eject operation completes.
- Partition-CAP associations are removed during library reboots, power cycles, library door open/close operations, or CAP initializations
- Partition-CAP associations are removed if the CAP becomes allocated to a different partition through the **Design (Step 3b)** screen.
- If a partition-CAP association is removed while the CAP is open or has cartridges in it, the CAP ownership will be changed to the “default” requester and the CAP will be unavailable to all partitions. You must empty and close the CAP before it can be associated to any partitions.

---

# Non-Disruptive Partitioning

The non-disruptive partitioning (NDP) feature minimizes the number of host interruptions that occur when partitions are modified. The library does not need to be taken offline for every partition change, and hosts are insulated from partition changes that do not affect them directly.

Prior to this feature, whenever a partition was changed in any way, all partitions would go offline while the library controller database was updated. As a result, library outages needed to be coordinated across all hosts connected to a partitioned library.

The specific functions of the NDP feature vary, depending on the type of host-partition connection. For details, see the following sections:

- [“NDP and HLI Partitions” on page 280](#)
- [“NDP and FC-SCSI Partitions” on page 281](#)

---

**Caution** – Although partition changes are not disruptive to library hosts, it is recommended that you make the library unavailable to other users before committing your partition workspace changes. Because the SL Console does not validate partition boundaries against the library controller database in real-time, configuration conflicts may arise if you change partition boundaries while other users are performing cartridge movements or library configuration changes. See [“Synchronizing the Display With the Controller Database” on page 36](#) for details.

---

## NDP and HLI Partitions

With HLI partitions, you can allocate additional resources to a partition without stopping host jobs or having the partition go offline. In general, a partition goes offline only when resources are de-allocated. In all cases, neighboring partitions are always left undisturbed.

## Allocating Additional Resources to a Partition

Whenever you make any of the following types of partition changes, the affected partition stays online:

- Allocate a storage cell
- Allocate a drive
- Allocate a CAP

The library controller sends an asynchronous message to all hosts connected to the partition that the library configuration has changed. The hosts experience a brief interruption as they update their library configuration information, and then they automatically continue processing jobs.

## Removing Allocations from a Partition

Whenever you make any of the following types of partition changes, the affected partition goes offline briefly:

- De-allocate a storage cell
- De-allocate a drive
- Remove an empty drive slot

After the configuration change is updated in the library controller database, the partition automatically comes back online and the library controller notifies all hosts connected to the partition that a configuration change has occurred. The hosts experience a brief interruption as they update their library configuration information, and then they automatically continue processing jobs.

## NDP and FC-SCSI Partitions

With FC-SCSI partitions, you can allocate a CAP to a partition without stopping host jobs or having the partition go offline.

All other changes to an FC-SCSI partition cause the affected partition to go offline with a Unit Attention condition. Neighboring partitions and their connected hosts are not disturbed.

## Host Connection Changes

Host connection changes include the following activities:

- Add a host-partition connection
- Change the properties of a host-partition connection
- Delete a host-partition connection

Whenever you make any of these changes, the affected partition goes offline with a LUNS Data Has Changed Unit Attention condition. The hosts connected to the partition must issue the appropriate commands to update their library configuration information. See the appropriate tape management software documentation for detailed procedures and commands.

If a host has unique ITL nexus connection mappings for each partition connection, then only the partition experiencing the connection change is affected. However, because the SL3000 library supports only one target port (0), it is possible that a host with multiple partition connections may reference the same target/LUN pair for each one. In this case, whenever one host-partition connection is changed, all partitions the host has connections to are also affected.

## Partition Configuration Changes

Partition configuration changes include the following activities:

- Allocate a storage cell
- Allocate a drive
- De-allocate a storage cell
- De-allocate a drive

- De-allocate a CAP
- Remove an empty drive slot

Whenever you make any of these changes, the affected partition goes offline with a Mode Parameters Have Changed Unit Attention condition. The hosts connected to the partition must issue the appropriate commands to update their library configuration information; see the appropriate tape management software documentation for detailed procedures and commands. In the case of adding or removing drives, the device SCSI numbering is updated as well.

---

# Partitioning Process

---

**Note** – Library partitioning is a licensed feature which must be installed through the SL3000 licensing utility. See [Chapter 4, “Licensing”](#) for details.

---

## Partition Configuration Process

When configuring library partitions for the first time, it is recommended that you use the library partition screens in the following sequence:

1. **Instructions (Step 1)** – Review summary instructions for the partition configuration process.
2. **Summary (Step 2)** – Display summary partition configuration and host-partition connection information. Optionally access other screens to perform the following tasks:
  - Add Partition
  - Modify Partition
  - Delete Partition

---

**Note** – The following tasks are available for FC-SCSI host-partition connections only.

---

- Add Connection
  - Modify Connection
  - Delete Connection
3. **Module Map (Step 3a)** – Select the library module for which you want to design detailed partition boundaries.
  4. **Design (Step 3b)** – Display and optionally modify detailed partition boundary information. Optionally access other screens to perform the following tasks:
    - Verify Partition Configurations
    - Refresh the display with current data from the library controller database
  5. **Commit (Step 4)** – Commit all changes made in the **Summary(2)** and **Design (3b)** screens, and all associated popups, to the library controller database. Optionally access other screens to perform the following task:
    - Refresh the display with current data from the library controller database

You can use the **Reports** screen at any time to display, and optionally save or print, partition configuration information from the library controller database.

## SL Console Partition Workspace

The partition **Summary (Step 2)** and **Design (Step 3b)** screens, and all associated popups, give you a dynamic workspace to design your library partitions. All partition configuration information is automatically saved to the partition workspace in SL Console memory and retained for the duration of your SL Console session. This allows you to switch among partition views and leave and return to the partition screens any number of times without losing your configuration changes.

Information in the SL Console partition workspace is committed to the library controller database only through the **Commit (Step 4)** screen. The information is lost if any one of the following occurs before you have committed your updates:

- You actively log off the SL Console session.
- The SL Console session times out or the connection to the library is lost.
- You actively refresh the SL Console workspace from the current library controller database. This is done through the **Refresh** button on the **Summary (Step 2)** and **Design (Step 3b)** screens.

---

**Caution** – Although partition changes are not disruptive to library hosts, it is recommended that you make the library unavailable to other users before committing your partition workspace changes. Because the SL Console does not validate partition boundaries against the library controller database in real-time, configuration conflicts may arise if you change partition boundaries while other users are performing cartridge movements or library configuration changes. See [“Synchronizing the Display With the Controller Database” on page 36](#) for details.

---



---

# Partitioning Task Summary

Partitioning tasks are divided into the following categories:

- [“Partition Configuration Tasks” on page 286](#)
- [“Partition Management Tasks” on page 303](#)
- [“Partition Report Tasks” on page 316](#)
- [“CAP Operation Tasks” on page 323](#)

# Partition Configuration Tasks

<b>Task</b>	<b>Page</b>
<a href="#">Review Partitioning Instructions</a>	287
<a href="#">Create a Partition</a>	288
<a href="#">Configure a Host-Partition Connection (FC-SCSI partitions only)</a>	289
<a href="#">Design a Partition – Base, DEM, or CEM Modules</a>	291
<a href="#">Design a Partition – AEM Modules</a>	294
<a href="#">Verify Partition Configurations</a>	296
<a href="#">Resolve Orphaned Cartridges</a>	299
<a href="#">Commit Partition Configuration Changes</a>	300

## ▼ Review Partitioning Instructions

Use this procedure to review the partitioning process.

### 1. Select Tools > Partitions.

The first time you make this selection during an SL Console login session, the **Instructions (Step 1)** screen appears automatically.

**Instructions for Adding, Modifying, or Deleting Partitions and their Host Connections**

To create, modify or delete partitions first go to the **Summary** tab (Step 2). This tab will allow you to view all current partitions on the library, as well as their current connections. This tab has buttons to add, delete, or modify the partitions. If the **Add** button is selected, a dialog box will allow you to name the partition, set capacity size, and select an interface type. In the **Module Map** tab (Step 3a), you can quickly select a module for use in the **Design** tab (Step 3b). The **Design** tab allows you to add or remove resources, such as cells, drives, or CAPs to the partition using a graphical cell map. The **Modify** button will also direct you to a dialog box to modify the name, capacity size, and interface type of the partition. Then you can choose the **Design** tab to modify resources for a selected partition. To delete an existing partition, simply select a partition from the Partition Summary table in the **Summary** tab, and then click the **Delete Partition** button.

Note that making changes in the **Design** tab does not apply or commit the partition definitions/changes to the library. If you have completed defining or modifying your partitions you will need to go to the **Commit** tab (Step 4) to apply changes to the library by using the **Apply** button. This operation may be disruptive to the library. It is not necessary to do this separately for each partition; you can add or modify multiple partitions and then use the **Commit** tab to apply all of these changes as a single transaction.

For more detailed information about the operation of each of the tabs, please refer to the **Help** for the selected tab.

Sun SL3000    Comm Status    UserID: root    Library:crimson20.stortek.com

### 2. Review the instructions on the screen before proceeding with other partitioning tasks.

## ▼ Create a Partition

Use this procedure to create a new library partition and assign its storage capacity. You can create up to eight partitions, with IDs from 1–8.

1. Select **Tools > Partitions**, and click the **Summary (Step 2)** tab.

The **Summary (Step 2)** screen appears.

The screenshot shows the 'Partitions' window with the 'Summary (Step 2)' tab selected. It displays the following information:

Partition Allocation Summary						
Partition Number	Storage Cells	Drive Bays	CAPs	AEMs	CAP+AEM Cells	%Licensed Capacity
1	63	8	0	0	0	2.10%
2	44	8	1	1	260	1.47%

Buttons at the bottom of the table include 'Add Partition', 'Delete Partition', and 'Modify Partition'. Below the table, there is a section for 'Details For Partition 2'.

2. Click **Add Partition**.

The **Add Partition** popup appears.

The 'ADD A PARTITION' dialog box has the following fields:

- Select a partition ID:** A dropdown menu currently showing '3'.
- Name:** An empty text input field.
- Interface Type:** A dropdown menu currently showing 'Select interface type'.

Buttons at the bottom are 'OK' and 'Cancel'.

3. Select the **Partition ID** you want to add, and enter the **Name**, **Capacity**, and **Interface Type**.

---

**Note** – Partition IDs do not need to be contiguous. For example, you can create partition 2 and partition 4, with no partitions 1 or 3.

---

4. Click **OK**.

Your partition configuration changes are saved to the SL Console partition workspace for the duration of this login session.

To update the library controller database with all changes from this SL Console login session, see [“Verify Partition Configurations” on page 296](#) and [“Commit Partition Configuration Changes” on page 300](#).

## ▼ Configure a Host-Partition Connection

**Note** – This procedure applies to FC-SCSI host-partition connections only. HLI host-partition connections are configured through the host library management software (HSC or ACSLS), not through the SL Console. See the HSC or ACSLS documentation for details.

Use this procedure to configure the connection between a host and a selected partition. You must perform this procedure in order for the partition to be accessible by the host.

Each partition can have up to nine host connections, each with a unique LUN. Also, each host can connect to multiple partitions.

1. Select **Tools > Partitions**, and click the **Summary (Step 2)** tab.

The **Summary (Step 2)** screen appears.

The screenshot displays the SL3000 console interface for the Partitions Summary (Step 2) screen. The interface includes a navigation bar with tabs for Instructions (Step 1), Summary (Step 2), Module Map (Step 3a), Design (Step 3b), Commit (Step 4), Reports, and Current Partition Definitions. A Refresh button and a help icon are also present.

**Total Library Resources**

Storage Cells:	3071
Drive Bays:	24
CAPs:	5
AEMs:	2
CAP cells:	130
AEM cells:	468
Licensed Capacity:	3000

**Resources Allocated**

Storage Cells:	107
Drive Bays:	16
CAPs:	1
AEMs:	1
CAP cells:	26
AEM cells:	234
Licensed Capacity:	107

**Resources Unallocated**

Storage Cells:	2964
Drive Bays:	8
CAPs:	4
AEMs:	1
CAP cells:	104
AEM cells:	234
Licensed Capacity:	2893

**Partition Allocation Summary**

Partition Number	Storage Cells	Drive Bays	CAPs	AEMs	CAP+AEM Cells	%Licensed Capacity
1	63	8	0	0	0	2.10%
2	44	8	1	1	260	1.47%

Buttons: Add Partition, Delete Partition, Modify Partition

**Details For Partition 2**

Name: Partition 2  
Interface Type: HLI

**NOTE: Users cannot specify the connections for the HLI partitions.**

**Connections**

Initiator (WWPN)	Target Port	LUN

Buttons: Add Connection, Delete Connection, Modify Connection

SL3000 Comm Status UserID: root Library:crimson6.central.sun.com

2. Click the partition to which you want to add a host connection

**Note** – If you select an HLI partition, all the buttons in the Details section of the screen are grayed out.

3. Click **Add Connection**.

The **Add Connection** popup appears.

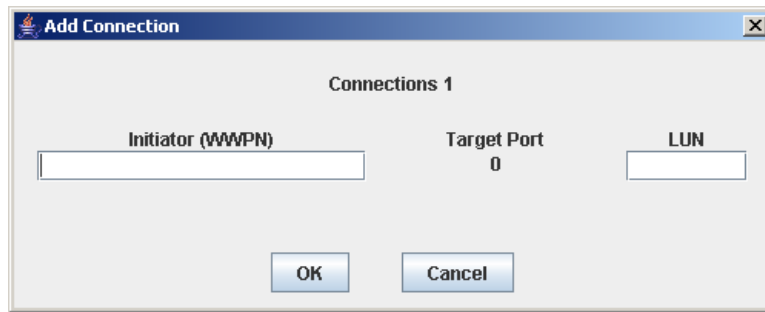

4. Enter the Initiator (WWPN) and LUN.

---

**Note** – Each initiator connected to the library must have one library partition assigned to LUN 0. When you verify or commit partition configuration changes, the SL Console will notify you if an initiator does not meet this requirement.

---

5. Click **OK**.

## ▼ Design a Partition – Base, DEM, or CEM Modules

Use this procedure to add or remove library resources (storage cells, tape drives, and rotational CAPs) from a partition.

---

**Note** – This procedure applies to Base, DEM, or CEM modules. See [“Design a Partition – AEM Modules” on page 294](#) for detailed instructions on allocating or de-allocating an AEM CAP to or from a partition.

---

**Note** – Library resources can be allocated to only one partition at a time. If you want to add resources to a partition but the resources are already allocated to another partition, you must first remove the resources from the assigned partition, and then add them to the new partition.

---

1. Select **Tools > Partitions**.
2. Click the **Module Map (Step 3a)** tab.

The **Module Map (Step 3a)** screen appears.

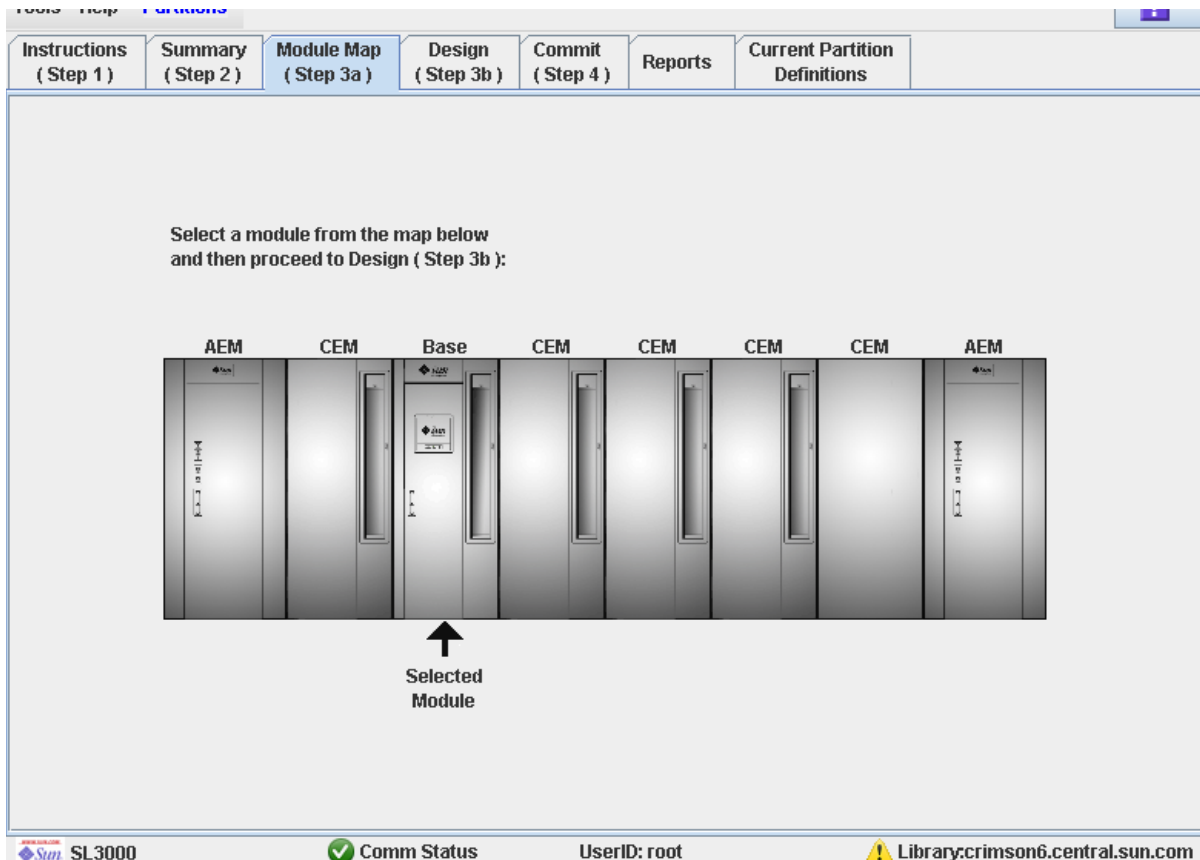

3. Click the module for which you want to design a partition.

4. Click the Design (Step 3b) tab.

The **Design (Step 3b)** screen appears, displaying the current configuration of the module you have selected.

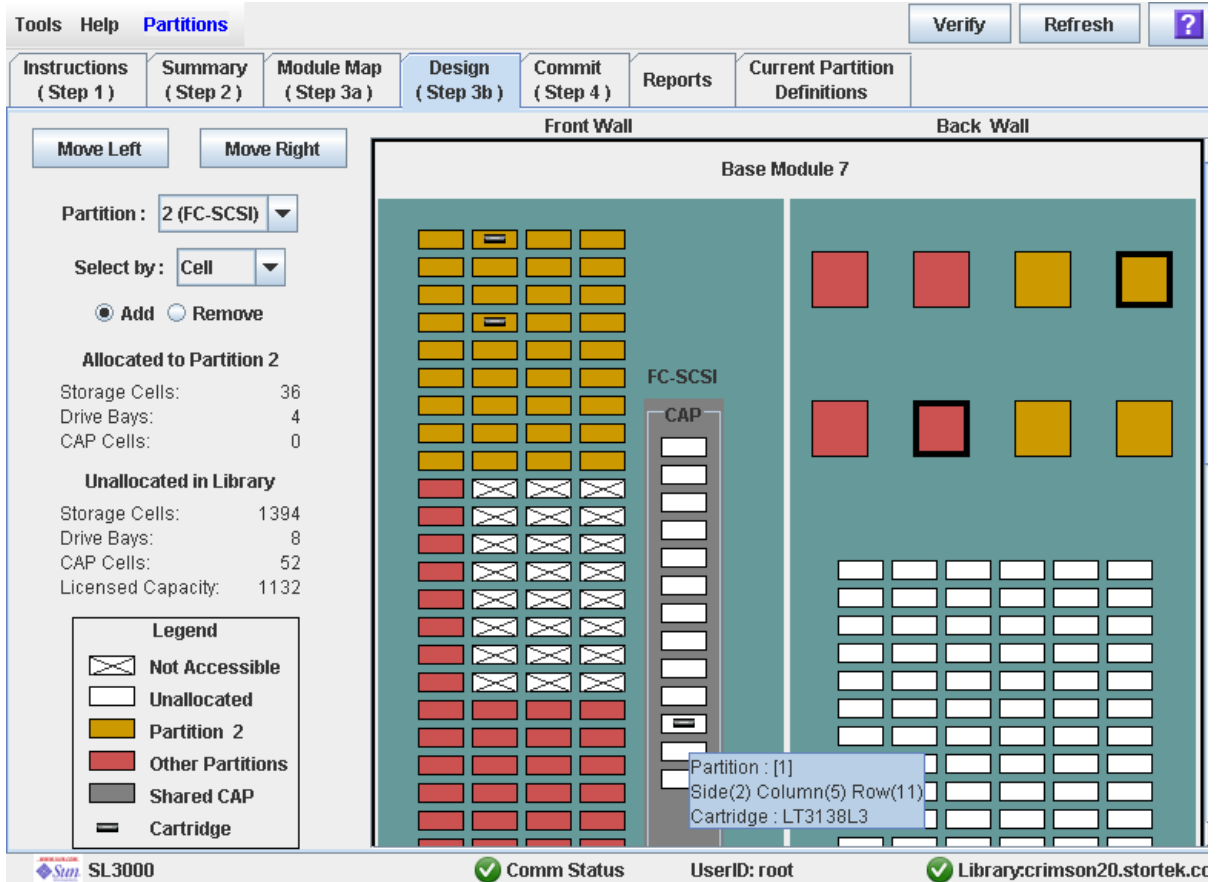

5. In the Partition pull-down menu, select the partition you want to configure.

All screen fields are updated to reflect the current configuration for the selected partition.

**Note** – Click the **Move Left** or **Move Right** buttons to display a module directly adjacent to the one currently displayed.

6. Choose the Select by method, and click either the Add or Remove radio button.

7. Use the library map to select the resources you want to add or remove.



---

**Note** – See [“Partitions—Design \(Step 3b\)” on page 356](#) for detailed instructions on using the library map.

---

Your partition configuration changes are saved to the SL Console partition workspace for the duration of this login session.

To update the library controller database with all changes from this SL Console login session, see [“Verify Partition Configurations” on page 296](#) and [“Commit Partition Configuration Changes” on page 300](#).

## ▼ Design a Partition – AEM Modules

Use this procedure to add or remove an AEM CAP to or from a partition.

You can allocate or de-allocate the entire AEM at one time; it is not possible to allocate just part of an AEM to a partition. AEMs can be shared by multiple partitions that share the same host-partition interface (HLI or FC-SCSI).

---

**Note** – See “Design a Partition – Base, DEM, or CEM Modules” on page 291 for detailed instructions on adding or removing library resources in Base, DEM, or CEM modules to or from a partition.

---

1. Select Tools > Partitions.
2. Click the Module Map (Step 3a) tab.

The **Module Map (Step 3a)** screen appears.

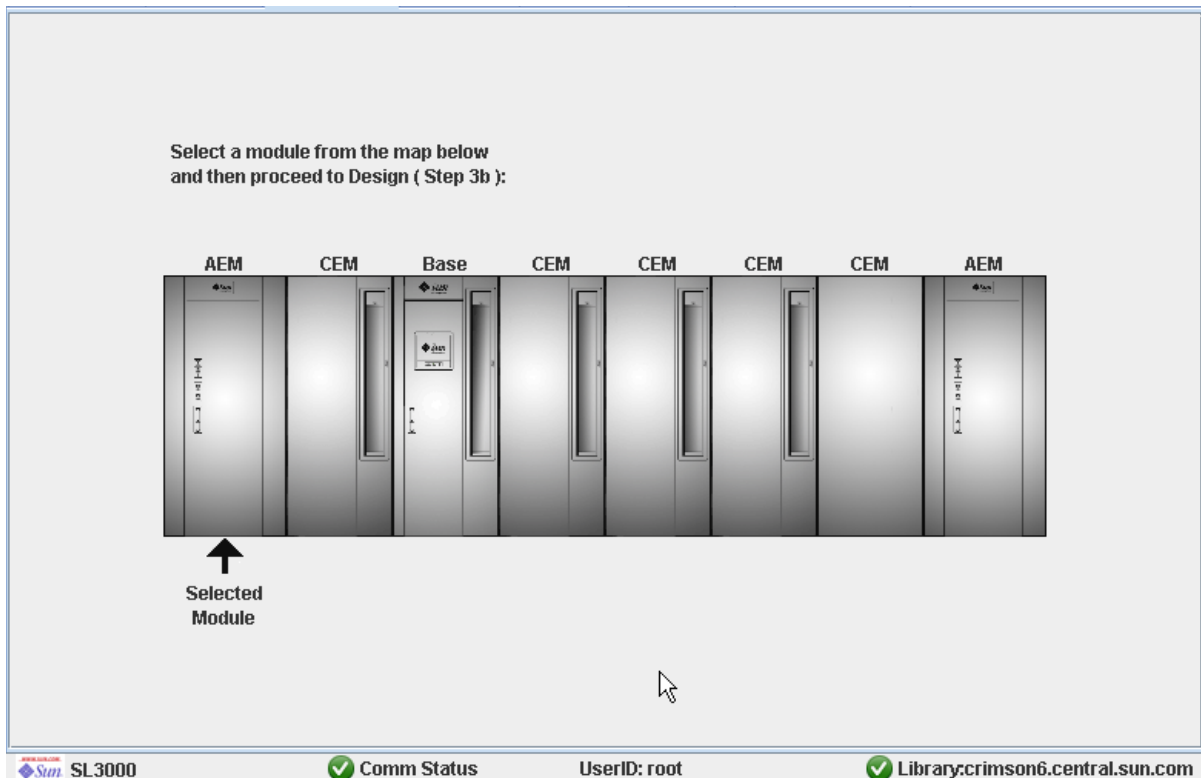

3. Click the AEM you want to allocate to a partition.

4. Click the Design (Step 3b) tab.

The **Design (Step 3b)** screen appears, displaying the current configuration of the AEM you have selected.

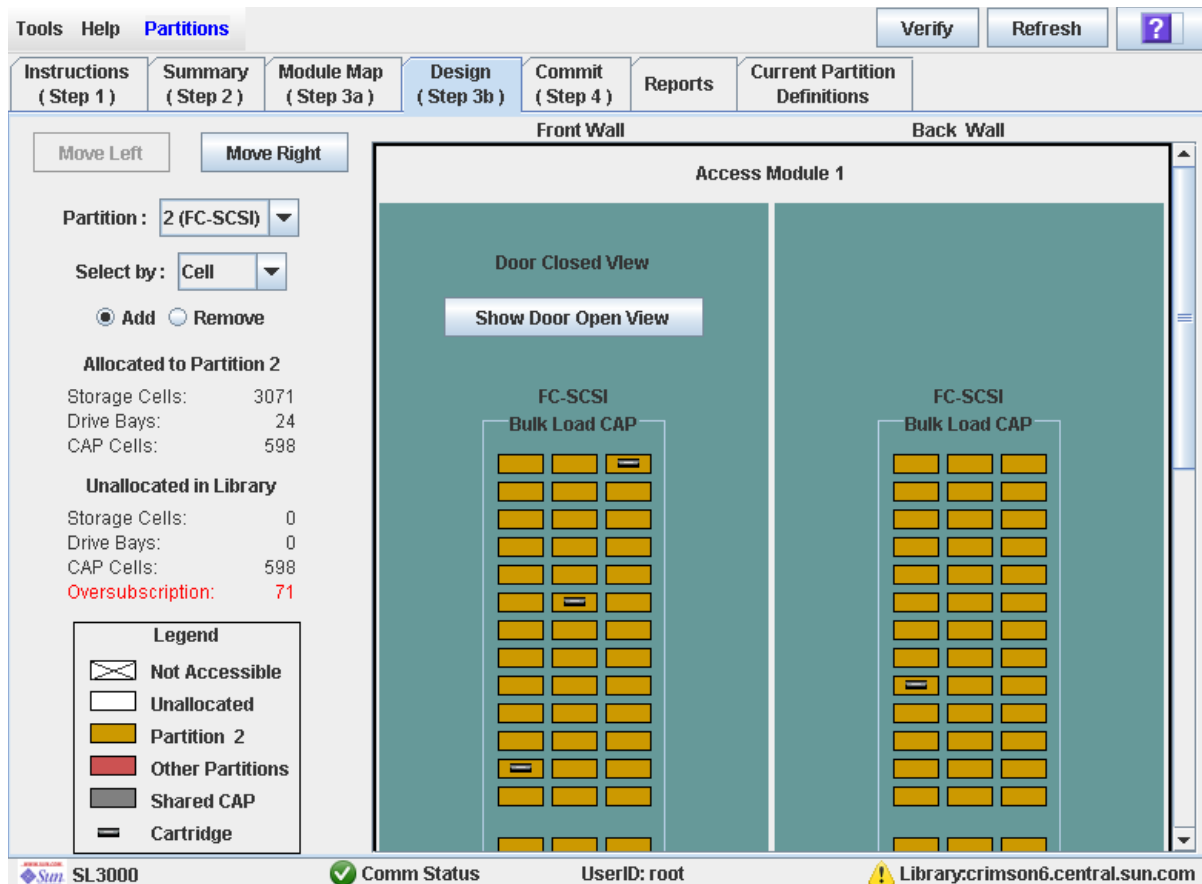

5. In the Partition pull-down menu, select the partition you want to configure.

All screen fields are updated to reflect the current configuration for the selected partition.

---

**Note** – Click the **Move Left** or **Move Right** buttons to display a module directly adjacent to the one currently displayed.

---

6. Click either the Add or Remove radio button.

7. Click anywhere on the library map to select the AEM and indicate that you want to allocate or de-allocate it to or from the partition.

Your partition configuration changes are saved to the SL Console partition workspace for the duration of this login session.

To update the library controller database with all changes from this SL Console login session, see [“Verify Partition Configurations” on page 296](#) and [“Commit Partition Configuration Changes” on page 300](#).

## ▼ Verify Partition Configurations

Use this procedure to verify partition configuration changes you have made during this SL Console login session. This procedure warns you of the following possible errors:

- A partition has orphaned cartridges. See [“Orphaned Cartridges in Partitioned Libraries” on page 273](#) for details.
- Library resources have been removed from a partition.
- A host connected to the library does not have a partition assigned to LUN 0.
- The library’s licensed capacity is oversubscribed; that is total partition allocations exceed licensed capacity.

---

**Note** – This procedure verifies only one partition at a time. If you need to verify multiple partitions, you must repeat this procedure separately for each partition.

---

1. Select **Tools > Partitions**.
2. Click the **Module Map (Step 3a)** tab.

The **Module Map (Step 3a)** screen appears.

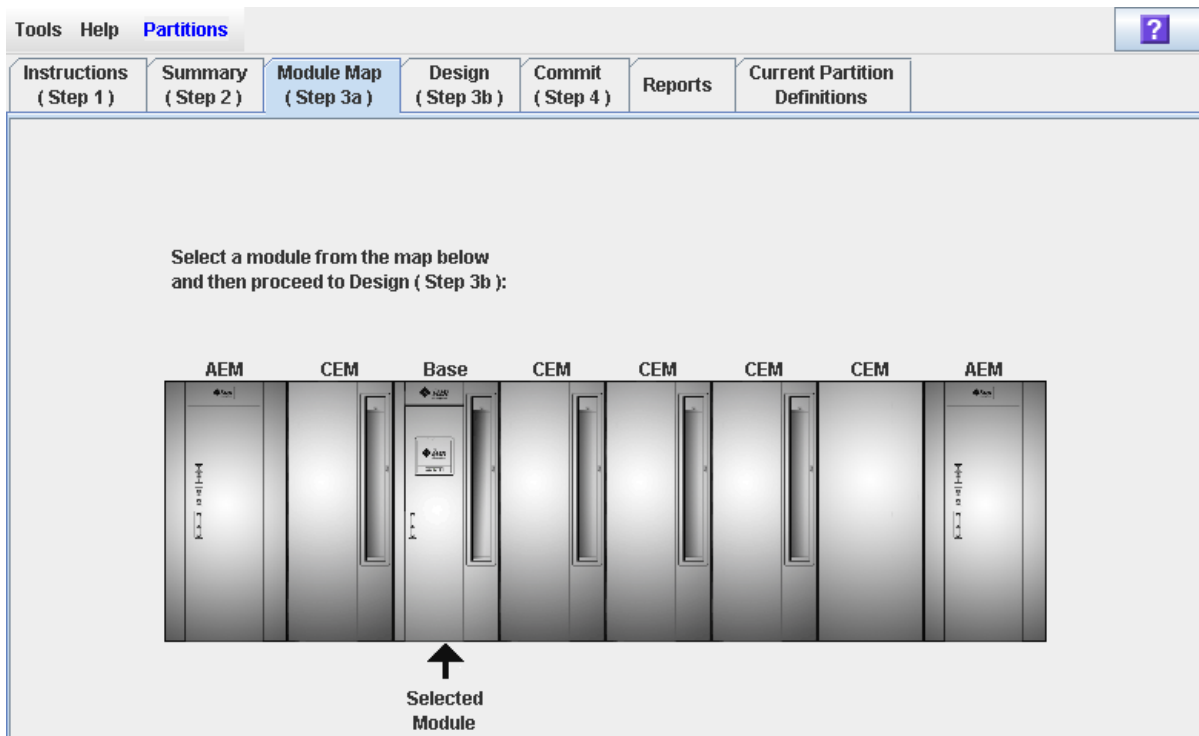

3. Click the module for which you want to verify a partition.
- The module is highlighted on the screen.

4. Click the **Design (Step 3b)** tab.

The **Design (Step 3b)** screen appears, displaying the current configuration of the module you have selected.



5. In the **Partition** pull-down menu, select the partition you want to verify.

All screen fields are updated to reflect the current configuration for the selected partition.

6. In the **Options Bar**, click **Verify**.

The boundaries of the selected partition are verified, including the locations of all tape cartridges.

---

**Note** – This verification is performed on the current partition configuration in the SL Console partition workspace only. It does not verify current partition boundaries against the library controller database; therefore it cannot identify configuration conflicts that may arise due to other users performing cartridge movements or library configuration changes—through the command line interface, other SL Console sessions, or host applications—at the same time you have made partition changes.

---

The **Verify Results** popup appears, indicating whether there are any orphaned cartridges, oversubscribed storage capacity, or other errors in the current partition configuration.

---

**Note** – If library capacity is oversubscribed (that is, total partition allocations exceed licensed capacity), before you can proceed to [“Commit Partition Configuration Changes” on page 300](#), you must remove storage cells from partition allocations to bring the total allocated cells within the library’s licensed capacity.

---

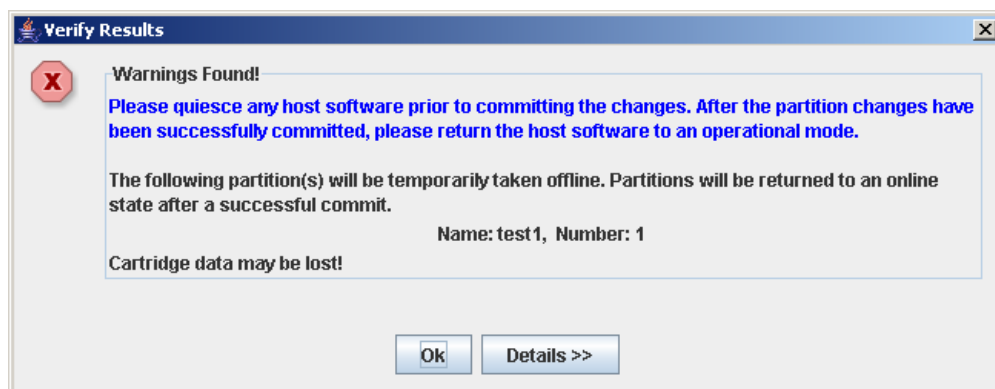

7. To display detailed warning messages explaining the reasons for any orphaned cartridges, click **Details**.

You can use the **Details** button to toggle between the expanded and collapsed views of the warning messages.

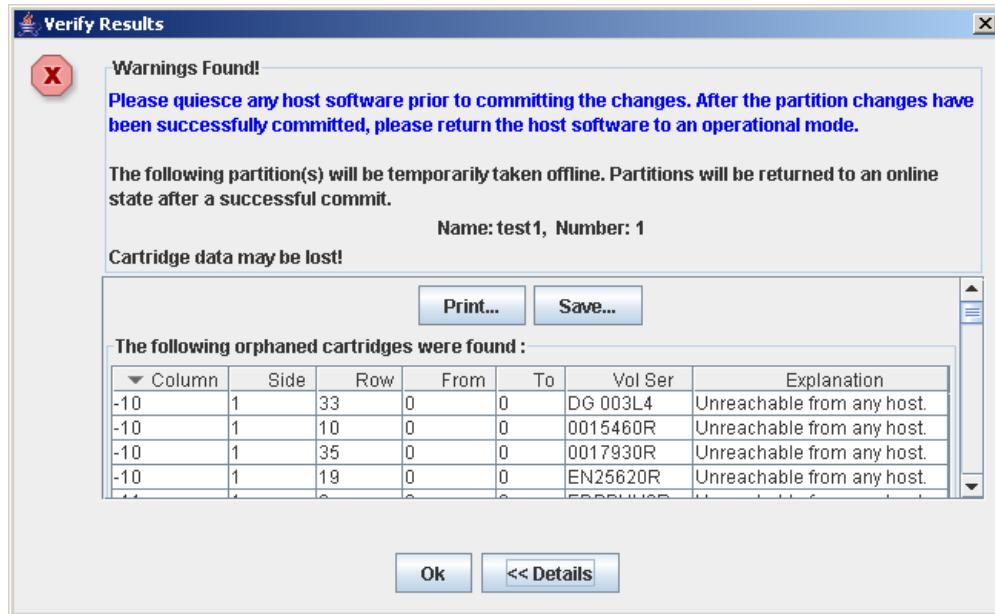

8. Optionally, in the expanded view of the warning messages you can do the following:
  - Click **Print** to print the detailed message data.
  - Click **Save** to save the detailed message data to a comma-separated file.
9. Click **OK** to dismiss the **Verify Results** popup and return to the **Design (Step 3b)** screen.

---

**Note** – It is recommended that you follow the [“Resolve Orphaned Cartridges”](#) on [page 299](#) procedure before committing your changes to the library controller database.

---

## ▼ Resolve Orphaned Cartridges

If the SL Console identifies an orphaned cartridge, it displays a warning message. You should resolve and disposition all orphaned cartridges before proceeding to [“Commit Partition Configuration Changes” on page 300](#).

You can performing any of the following actions to resolve orphaned cartridges:

- Print a report of orphaned cartridges.
- Perform an audit of the library.
- Perform a recovery move on an orphaned cartridge.

## ▼ Commit Partition Configuration Changes

---

**Caution** – This procedure updates the library controller database with all partition configuration changes you have made during this SL Console session. Failure to use this procedure before logging out of the current SL Console session will cause all your library configuration changes to be lost.

---

---

**Caution** – Although partition changes are not disruptive to library hosts, it is recommended that you make the library unavailable to other users before committing your partition workspace changes. Because the SL Console does not validate partition boundaries against the library controller database in real-time, configuration conflicts may arise if you change partition boundaries while other users are performing cartridge movements or library configuration changes. See [“Synchronizing the Display With the Controller Database” on page 36](#) for details.

---

---

**Note** – It is recommended that you follow the [“Resolve Orphaned Cartridges” on page 299](#) procedure before performing this procedure.

---

---

**Note** – You cannot perform this procedure if current library capacity is oversubscribed (that is, total partition allocations exceed licensed capacity). The **Apply** button is grayed out, and before you can proceed, you must remove storage cells from partition allocations to bring the total allocated cells within the library’s licensed capacity.

---

**1. Vary the library offline to ACSLS and HSC.**

See the appropriate tape management software documentation for the procedures and commands.

**2. Select Tools > Partitions, and click the Commit (Step 4) tab.**

The **Commit (Step 4)** screen appears.

**3. In the Options Bar, click Apply.**

The boundaries of the selected partition are verified, including the locations of all tape cartridges.



**Note** – This verification is performed on the current partition configuration in the SL Console partition workspace only. It does not verify current partition boundaries against the library controller database; therefore it cannot identify configuration conflicts that may arise due to other users performing cartridge movements or library configuration changes—through the command line interface, other SL Console sessions, or host applications—at the same time you have made partition changes.

The **Confirm Apply** popup appears, indicating whether there are any orphaned cartridges or other problems in the current partition configuration.

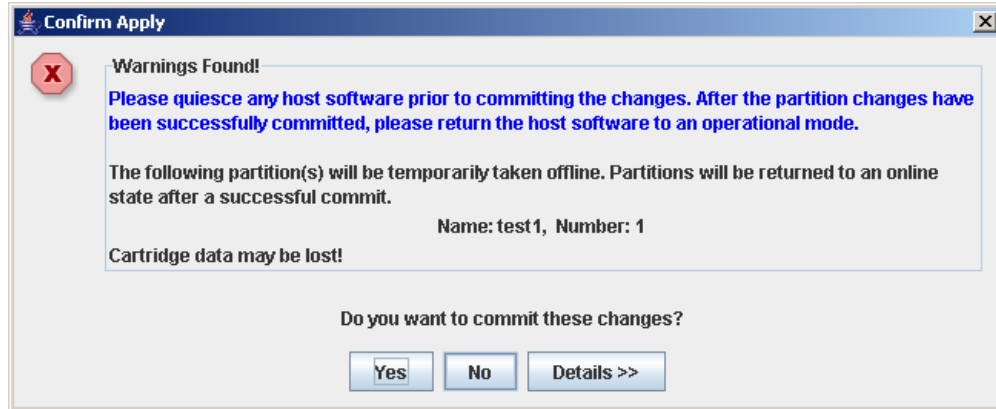

- To display detailed warning messages explaining the reasons for any orphaned cartridges, click **Details**.

You can use the **Details** button to toggle between the expanded and collapsed views of the warning messages.

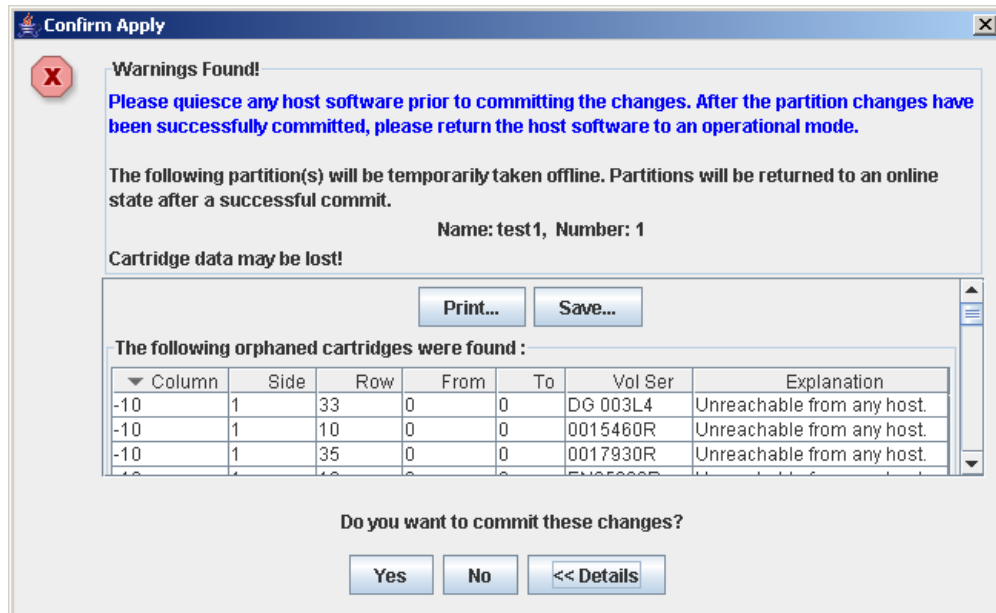

- Optionally, in the expanded view of the warning messages you can do the following:
  - Click **Print** to print the detailed message data.
  - Click **Save** to save the detailed message data to a comma-separated file.

**6. Proceed as follows:**

- Click **No** to cancel the update. The library controller database is not updated, but all partition changes from this login session are retained in the SL Console partition workspace.
- Click **Yes** to update the library controller database.

The **Commit Success** popup appears.

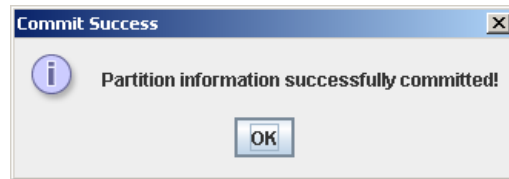

Click **OK** to return to the **Commit (Step 4)** screen.

- 7. All affected library host applications must now be configured to recognize these updates. See the appropriate tape management software documentation for the procedures and commands.**

---

# Partition Management Tasks

<b>Task</b>	<b>Page</b>
<a href="#">Modify Partition Summary Information</a>	304
<a href="#">Delete a Partition</a>	305
<a href="#">Modify the Interface Type of a Host-Partition Connection</a>	307
<a href="#">Modify FC-SCSI Host-Partition Connection Detail</a>	309
<a href="#">Delete a FC-SCSI Host-Partition Connection</a>	311
<a href="#">Refresh the SL Console Partition Workspace</a>	313
<a href="#">Reallocate Library Resources</a>	314
<a href="#">Make a Hardware Change to a Partitioned Library</a>	315

## ▼ Modify Partition Summary Information

Use this procedure to change the name or allocated storage capacity of an existing partition.

**Note** – To change the host-partition connection type (HLI or FC-SCSI), see [“Modify the Interface Type of a Host-Partition Connection”](#) on page 307.

**Note** – You cannot change the partition ID. To assign a different Partition ID, you must delete the old partition and create a new one with the new ID.

1. Select **Tools > Partitions**, and click the **Summary (Step 2)** tab.

The **Summary (Step 2)** screen appears.

The screenshot shows the 'Partitions' window with the 'Summary (Step 2)' tab selected. On the left, there are two sections: 'Total Library Resources' and 'Resources Allocated'. The 'Total Library Resources' section lists: Storage Cells: 3071, Drive Bays: 24, CAPs: 5, AEMs: 2, CAP cells: 130, AEM cells: 468, and Licensed Capacity: 3000. The 'Resources Allocated' section lists: Storage Cells: 107, Drive Bays: 16, and CAPs: 1. The main area is titled 'Partition Allocation Summary' and contains a table with the following data:

Partition Number	Storage Cells	Drive Bays	CAPs	AEMs	CAP+AEM Cells	%Licensed Capacity
1	63	8	0	0	0	2.10%
2	44	8	1	1	260	1.47%

Below the table are three buttons: 'Add Partition', 'Delete Partition', and 'Modify Partition'. At the bottom, there is a section for 'Details For Partition 2' which is currently empty.

2. In the Partition Summary section, select the partition you want to modify.

3. Click **Modify Partition**.

The **Modify a Partition** popup appears.

The 'MODIFY A PARTITION' dialog box is titled 'Modify Partition 1'. It contains two input fields: 'Name' with the value '111' and 'Interface Type' with a dropdown menu set to 'FC-SCSI'. At the bottom, there are 'OK' and 'Cancel' buttons.

4. Enter the changes you want to make.

5. Click **OK** to confirm the changes.

## ▼ Delete a Partition

Use this procedure to delete a partition from the library. The following changes are made to the library partition configuration:

- All resources allocated to the partition are marked available.
- All host connections for the partition are deleted.
- The partition ID is deleted.

---

**Caution** – Deleting partitions can result in orphaned cartridges and data that could be lost. See [“Orphaned Cartridges in Partitioned Libraries”](#) on page 273 for details.

---



---

**Note** – Deleting all partitions from the library causes the library state to change to “non-partitioned.” All active storage cells, drives, and rotational or AEM CAPs will be accessible to all hosts.

---

1. Select **Tools > Partitions**, and click the **Summary (Step 2)** tab.

The **Summary (Step 2)** screen appears.

**Tools Help Partitions** Refresh ?

**Instructions (Step 1) Summary (Step 2) Module Map (Step 3a) Design (Step 3b) Commit (Step 4) Reports Current Partition Definitions**

**Total Library Resources**

Storage Cells: 3071  
 Drive Bays: 24  
 CAPs: 5  
 AEMs: 2  
 CAP cells: 130  
 AEM cells: 468  
 Licensed Capacity: 3000

**Resources Allocated**

Storage Cells: 107  
 Drive Bays: 16  
 CAPs: 1

**Partition Allocation Summary**

Partition Number	Storage Cells	Drive Bays	CAPs	AEMs	CAP+AEM Cells	%Licensed Capacity
1	63	8	0	0	0	2.10%
2	44	8	1	1	260	1.47%

Add Partition Delete Partition Modify Partition

----- Details For Partition 2 -----

2. In the **Partition Summary** section, click the partition you want to remove.

3. Click **Delete Partition**.

A confirmation popup appears.

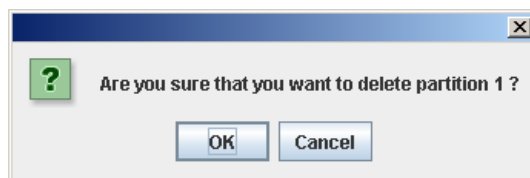

4. Click **OK** to confirm the deletion.

- If partitions still remain in the library, proceed to [Step 7](#).

- If no partitions remain, the **Select Library Interface Type** popup appears.

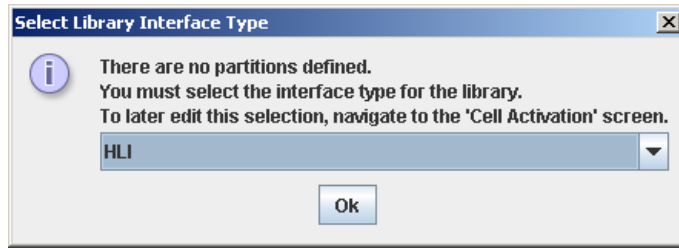

5. **Select the library interface type you want to assign for all host connections to the library. Options are:**

- HLI
- FC-SCSI

6. **Click OK to confirm the change.**

7. **The updates are made as follows:**

Your partition configuration changes are saved to the SL Console partition workspace for the duration of this login session.

To update the library controller database with all changes from this SL Console login session, see [“Verify Partition Configurations” on page 296](#) and [“Commit Partition Configuration Changes” on page 300](#).

If there are no partitions remaining in the library, when you commit the updates the library state will change to “non-partitioned”.

## ▼ Modify the Interface Type of a Host-Partition Connection

Use this procedure to change the host-partition connection type of an existing partition. You should use this procedure with caution, due to the following possible effects:

- Changing the interface type can result in the loss of active host connections.
- Changing the interface type from FC-SCSI to HLI can result in the loss of FC-SCSI connection detail.
- Because rotational and AEM CAPs cannot be shared across partition types, changing the interface type can result in the loss of existing shared CAP assignments. Dedicated CAP assignments are not affected.

**Note** – To change the name or allocated storage capacity of an existing partition, see [“Modify Partition Summary Information” on page 304](#).

1. Select **Tools > Partitions**, and click the **Summary (Step 2)** tab.

The **Summary (Step 2)** screen appears.

The screenshot shows the 'Partition Allocation Summary' screen. On the left, there are sections for 'Total Library Resources' and 'Resources Allocated'. The main area contains a table with the following data:

Partition Number	Storage Cells	Drive Bays	CAPs	AEMs	CAP+AEM Cells	%Licensed Capacity
1	63	8	0	0	0	2.10%
2	44	8	1	1	260	1.47%

Below the table are buttons for 'Add Partition', 'Delete Partition', and 'Modify Partition'. At the bottom, there is a section for 'Details For Partition 2'.

2. In the Partition Summary section, click the partition you want to modify.
3. Click **Modify Partition**.

The **Modify a Partition** popup appears.

The 'MODIFY A PARTITION' dialog box is shown. It has a title bar that says 'MODIFY A PARTITION' and a close button. The main area is titled 'Modify Partition 1'. It contains two input fields: 'Name' with the value '111' and 'Interface Type' with a pull-down menu showing 'FC-SCSI'. At the bottom, there are 'OK' and 'Cancel' buttons.

4. In the Interface Type pull-down, select the interface type you want to assign. Click **OK**.

- The SL Console checks the current partition configuration in the SL Console workspace. If the partition has shared CAP allocations or, in the case of FC-SCSI partitions, host-partition connection detail, warning popups will appear. Following are sample popups that may appear.

- Changing from HLI to FC-SCSI:

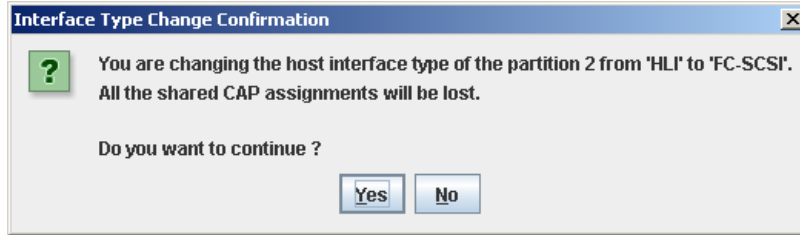

- Changing from FC-SCSI to HLI:

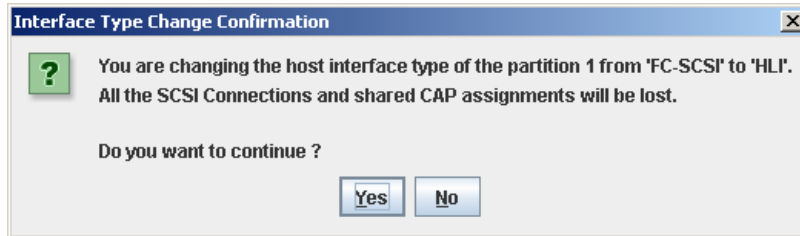

- Click Yes to confirm the change.

Your partition configuration changes are saved to the SL Console partition workspace for the duration of this login session.

To update the library controller database with all changes from this SL Console login session, see [“Verify Partition Configurations” on page 296](#) and [“Commit Partition Configuration Changes” on page 300](#).



## ▼ Modify FC-SCSI Host-Partition Connection Detail

**Note** – This procedure applies to FC-SCSI host-partition connections only. HLI host-partition connections are configured through the host library management software (HSC or ACSLS), not through the SL Console. See the HSC or ACSLS documentation for details.

Use this procedure to modify the host World Wide Port Name or LUN number of the library for a host-partition connection.

**Note** – You cannot modify the target port number for the library; it is always “0”.

1. Select **Tools > Partitions**, and click the **Summary (Step 2)** tab.

The **Summary (Step 2)** screen appears.

The screenshot displays the Sun Storage Configuration Manager (SL3000) interface. The top navigation bar includes 'Tools', 'Help', and 'Partitions'. The 'Partitions' section is active, showing a 'Summary (Step 2)' tab. The interface is divided into several sections:

- Total Library Resources:**
  - Storage Cells: 3071
  - Drive Bays: 24
  - CAPs: 5
  - AEMs: 2
  - CAP cells: 130
  - AEM cells: 468
  - Licensed Capacity: 3000
- Resources Allocated:**
  - Storage Cells: 107
  - Drive Bays: 16
  - CAPs: 1
  - AEMs: 1
  - CAP cells: 26
  - AEM cells: 234
  - Licensed Capacity: 107
- Resources Unallocated:**
  - Storage Cells: 2964
  - Drive Bays: 8
  - CAPs: 4
  - AEMs: 1
  - CAP cells: 104
  - AEM cells: 234
  - Licensed Capacity: 2893
- Partition Allocation Summary:**

Partition Number	Storage Cells	Drive Bays	CAPs	AEMs	CAP+AEM Cells	%Licensed Capacity
1	63	8	0	0	0	2.10%
2	44	8	1	1	260	1.47%
- Details For Partition 2:**
  - Name: Partition 2
  - Interface Type: HLI
  - NOTE: Users cannot specify the connections for the HLI partitions.**
  - Connections:**

Initiator (WWPN)	Target Port	LUN

The interface also includes buttons for 'Add Partition', 'Delete Partition', 'Modify Partition', 'Add Connection', 'Delete Connection', and 'Modify Connection'. The status bar at the bottom shows 'SL3000', 'Comm Status', 'UserID: root', and 'Library:crimson6.central.sun.com'.

2. In the **Summary** section of the screen, click the partition for which you want to modify a connection.
3. In the **Connections** section, click the host-partition connection you want to modify.

---

**Note** – If you select an HLI partition, all the buttons in the Details section of the screen are grayed out.

---

**4. Click Modify Connection.**

The **Modify a Connection** popup appears.

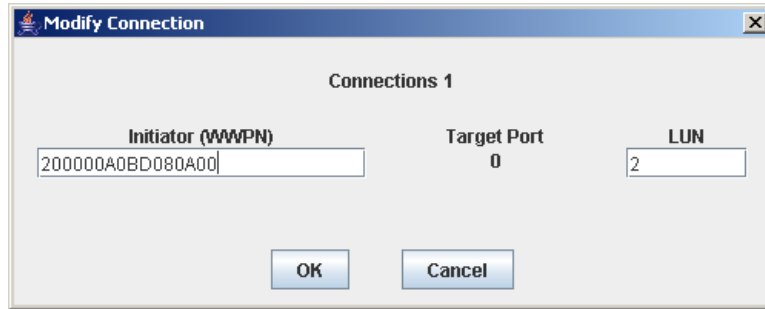

**5. Enter the changes you want to make.**

**6. Click OK to confirm the changes.**

Your partition configuration changes are saved to the SL Console partition workspace for the duration of this login session.

To update the library controller database with all changes from this SL Console login session, see [“Verify Partition Configurations” on page 296](#) and [“Commit Partition Configuration Changes” on page 300](#).

## ▼ Delete a FC-SCSI Host-Partition Connection

**Note** – This procedure applies to FC-SCSI host-partition connections only. HLI host-partition connections are configured through the host library management software (HSC or ACSLS), not through the SL Console. See the HSC or ACSLS documentation for details.

Use this procedure to delete a host-partition connection. After you perform this procedure, the host will no longer be able to access the partition.

1. Select **Tools > Partitions**, and click the **Summary (Step 2)** tab.

The **Summary (Step 2)** screen appears.

The screenshot shows the SL3000 console interface. At the top, there are tabs for 'Instructions (Step 1)', 'Summary (Step 2)', 'Module Map (Step 3a)', 'Design (Step 3b)', 'Commit (Step 4)', 'Reports', and 'Current Partition Definitions'. The 'Summary (Step 2)' tab is selected. Below the tabs, there are three main sections: 'Total Library Resources', 'Resources Allocated', and 'Resources Unallocated'. To the right of these sections is a 'Partition Allocation Summary' table with columns for Partition Number, Storage Cells, Drive Bays, CAPs, AEMs, CAP+AEM Cells, and %Licensed Capacity. Below this table are buttons for 'Add Partition', 'Delete Partition', and 'Modify Partition'. Below the buttons is a 'Details For Partition 2' section with fields for Name (Partition 2) and Interface Type (HLI). A note states: 'NOTE: Users cannot specify the connections for the HLI partitions.' Below the note is a 'Connections' table with columns for Initiator (WWPN), Target Port, and LUN. Below the connections table are buttons for 'Add Connection', 'Delete Connection', and 'Modify Connection'. At the bottom of the console, there is a status bar with 'SL3000', 'Comm Status', 'UserID: root', and 'Library:crimson6.central.sun.com'.

Partition Number	Storage Cells	Drive Bays	CAPs	AEMs	CAP+AEM Cells	%Licensed Capacity
1	63	8	0	0	0	2.10%
2	44	8	1	1	260	1.47%

Initiator (WWPN)	Target Port	LUN

2. In the Summary section of the screen, click the partition for which you want to delete a connection.

**Note** – If you select an HLI partition, all the buttons in the Details section of the screen are grayed out.

3. In the Connections section, click the host-partition connection you want to delete.

**4. Click Delete Connection.**

A confirmation popup appears.

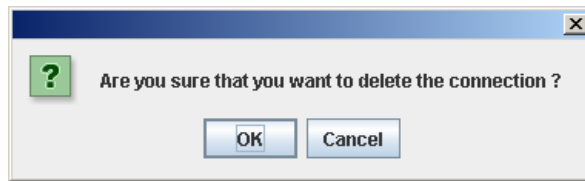

**5. Click OK to confirm the deletion.**

Your partition configuration changes are saved to the SL Console partition workspace for the duration of this login session.

To update the library controller database with all changes from this SL Console login session, see ["Verify Partition Configurations" on page 296](#) and ["Commit Partition Configuration Changes" on page 300](#).

## ▼ Refresh the SL Console Partition Workspace

Use this procedure to refresh the SL Console partition workspace with current data from the library controller database. The current data includes all updates that other users have made to the library controller database during your login session, through the command line interface, other SL Console sessions, or host applications.

---

**Note** – After you complete this procedure, all uncommitted partition changes you have made during this SL Console login session are discarded.

---

1. Select **Tools > Partitions**.
2. Click one of the following tabs:
  - **Summary (Step 2)**
  - **Design (Step 3b)**

The selected screen appears.



3. In the Options Bar, click **Refresh**.

The **Partition Refresh** popup appears.



4. Click **Yes** to confirm the refresh.

All partition screen data is updated with current data from the library controller database.

## ▼ Reallocate Library Resources

Reallocating library resources (storage cells, tape drives, rotational or AEM CAPs, or cartridges) from one partition to another is done through one of the following screens:

- [“Partitions—Design \(Step 3b\)” on page 356](#), for Base, Drive, and CEM modules
- [“Partitions—Design \(Step 3b\) – AEMs Only” on page 362](#), for AEM modules

You must use the following two-step process:

1. Remove the resource from the partition it is currently allocated to.
2. Allocate the resource to a different partition.

See [“Design a Partition – Base, DEM, or CEM Modules” on page 291](#) for detailed instructions.

---

**Caution** – Reallocating resources can result in orphaned cartridges and data that could be lost. See [“Orphaned Cartridges in Partitioned Libraries” on page 273](#) for details.

---

## ▼ Make a Hardware Change to a Partitioned Library

Some library hardware changes, such as adding expansion modules, adding a second robot, or adding rotational CAP cells, may require the removal of all or part of an existing partitioned module. Use the following process to make such hardware changes without losing partitioning information for the sections of the library that are unchanged.

---

**Caution** – Failure to follow this procedure could result in the loss of library partition configuration information after a hardware change.

---

1. De-allocate all library resources (storage cells, rotational and AEM CAPs, and drives) that will be removed as part of the hardware change from the partitions they are currently allocated to.  
See [“Design a Partition – Base, DEM, or CEM Modules” on page 291](#) for detailed instructions.
2. Power down the library.  
See [“Power Down the Library” on page 483](#) for detailed instructions.
3. Install the hardware change.
4. Power up the library.  
See [“Power Up the Library” on page 484](#) for detailed instructions.  
All partition allocations for the unchanged parts of the library remain in effect.
5. Allocate the library resources that have been added due to the hardware change.  
See [“Design a Partition – Base, DEM, or CEM Modules” on page 291](#) for detailed instructions.

---

**Caution** – Reallocating resources can result in orphaned cartridges and data that could be lost. See [“Orphaned Cartridges in Partitioned Libraries” on page 273](#) for details.

---

# Partition Report Tasks

<b>Task</b>	<b>Page</b>
<a href="#">Display a Partition Report</a>	317
<a href="#">Print Partition Report Data</a>	319
<a href="#">Save Partition Report Data</a>	320
<a href="#">Display Partition Detail</a>	321



## ▼ Display a Partition Report

Use this procedure to display any of the following partition reports:

- Cartridge Cell and Media Summary – Displays a detailed list of all resource partition assignments.
- Host Connections Summary – Displays detailed host-partition connection information for all partitions.
- Orphaned Cartridge Report – Displays a detailed list of all orphaned cartridges.
- Partition Details – Displays detailed information for a selected partition.
- Partition Summary – Displays summary information for all partitions.

---

**Note** – The partition reports display data saved to the library controller database. If you have made partition configuration changes without committing the changes to the library controller through the **Commit (Step 4)** screen, the data in these reports will differ from data shown on the partition **Summary (Step 2)** and **Design (Step 3b)** screens.

---

1. Select **Tools > Partitions**, and click the **Reports** tab.

The **Reports** screen appears.

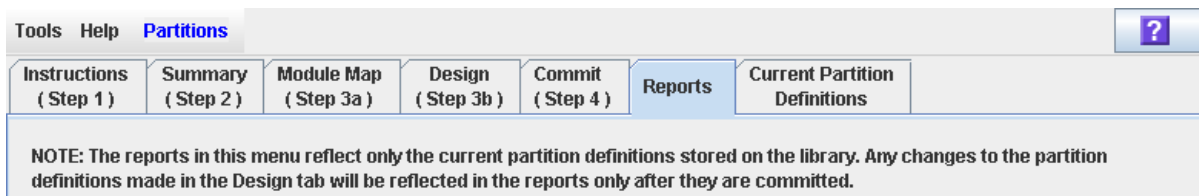

**2. In the pull-down menu, select the report you want to display.**

The screen is updated with current data from the library controller database.

The screenshot shows a software interface with a menu bar at the top containing 'Tools', 'Help', and 'Partitions'. Below the menu bar are several tabs: 'Instructions (Step 1)', 'Summary (Step 2)', 'Module Map (Step 3a)', 'Design (Step 3b)', 'Commit (Step 4)', 'Reports', and 'Current Partition Definitions'. The 'Reports' tab is active. A note states: 'NOTE: The reports in this menu reflect only the current partition definitions stored on the library. Any changes to the partition definitions made in the Design tab will be reflected in the reports only after they are committed.' Below the note is a pull-down menu currently set to 'Partition Summary'. The main area displays 'Partitions as of 7/23/09 1:30 PM' and a table with the following data:

Partition ID	Partition Name	Connectic Type	Storage Cells	Media in Storage Cells	%Storage Cells w/ Media	Drives	CAP Cells	AEM Cells	Active Cells
1	one	SCSI	793	101	12.74%	16	52	0	793
2	Two	SCSI	903	55	6.09%	24	26	0	903

At the bottom of the interface are buttons for 'Print...' and 'Save To File...'. The status bar at the very bottom shows 'SL3000', 'Comm Status' (with a green checkmark), 'UserID: root', and 'Library:crimson9.central.sun.com' (with a green checkmark).

**3. If you want to print the report data or save it to a file, see the following procedures:**

- [“Print Partition Report Data” on page 319](#)
- [“Save Partition Report Data” on page 320](#)

## ▼ Print Partition Report Data

Use this procedure to print a partition report. This procedure can be performed from any of the partition report screens.

1. **Select Tools > Partitions, and click the Reports tab.**

The **Reports** screen appears.



2. **In the pull-down menu, select any report.**

The specified report is displayed. All report screens include the **Print** and **Save to File** buttons.

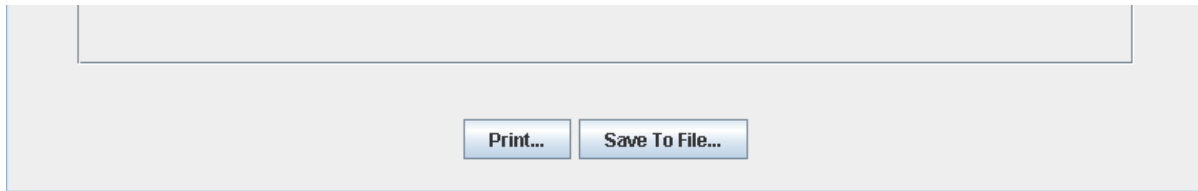

3. **Click Print.**

The **Print** popup appears.

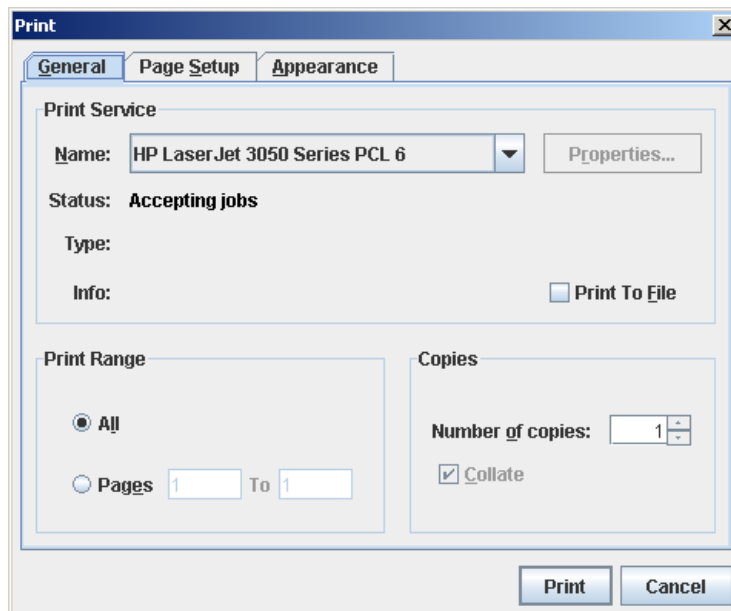

4. **Complete the print popup, and click Print.**

The report is printed to the selected printer.

## ▼ Save Partition Report Data

Use this procedure to save partition report data to a comma-separated file (.csv format). You can use a variety of spreadsheet applications to view the file. This procedure can be performed from any of the partition report screens.

1. **Select Tools > Partitions, and click the Reports tab.**

The **Reports** screen appears.



2. **In the pull-down menu, select any report.**

The specified report is displayed. All report screens include the **Print** and **Save to File** buttons.

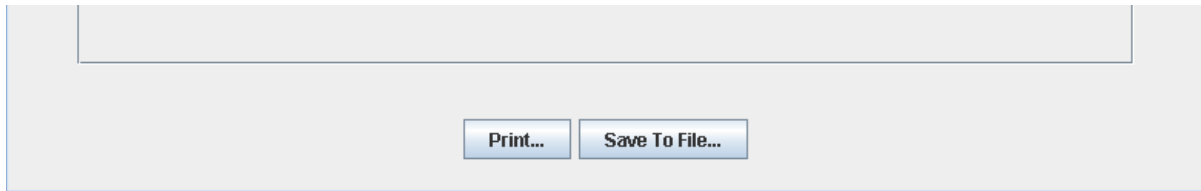

3. **Click Save to File.**

The **Save** popup appears.

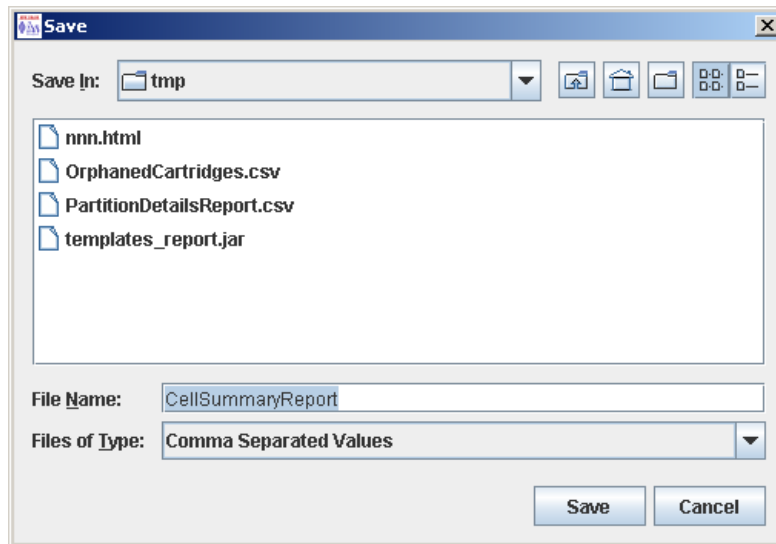

4. **Browse to the directory where you want to save the file, and enter the file name.**

5. **Click Save.**

The data is saved to the specified file.

## ▼ Display Partition Detail

Use this procedure to display current partition boundaries and allocations. You can also display detailed information about cartridge, drive, and storage cell locations.

---

**Note** – This procedure is available on the local operator panel.

---

1. Select **Tools > Partitions**.
2. Click the **Module Map (Step 3a)** tab.

The **Module Map (Step 3a)** screen appears.

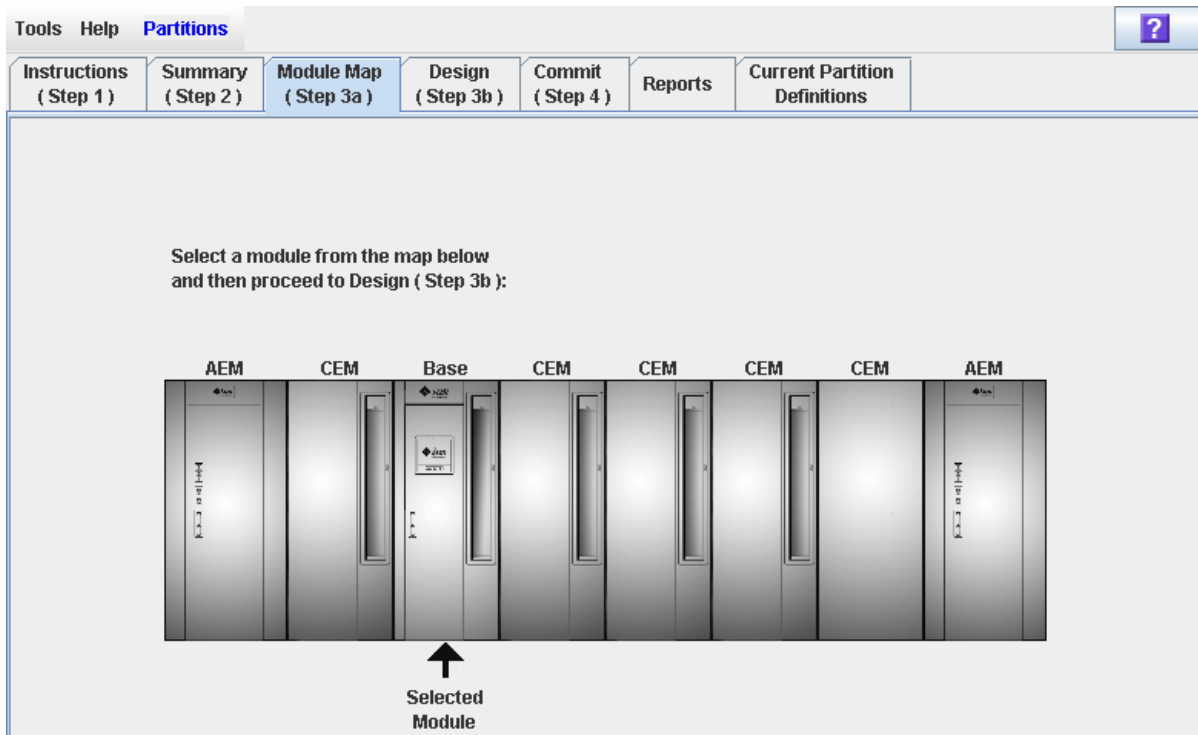

3. Click the module you want to display.
- The module is highlighted on the screen.

4. Click the **Current Partition Definitions** tab.

The **Partition Definitions** screen appears, displaying the current configuration of the module you have selected.

You can mouse-over a cell to display a tooltip of detailed information about the cell.

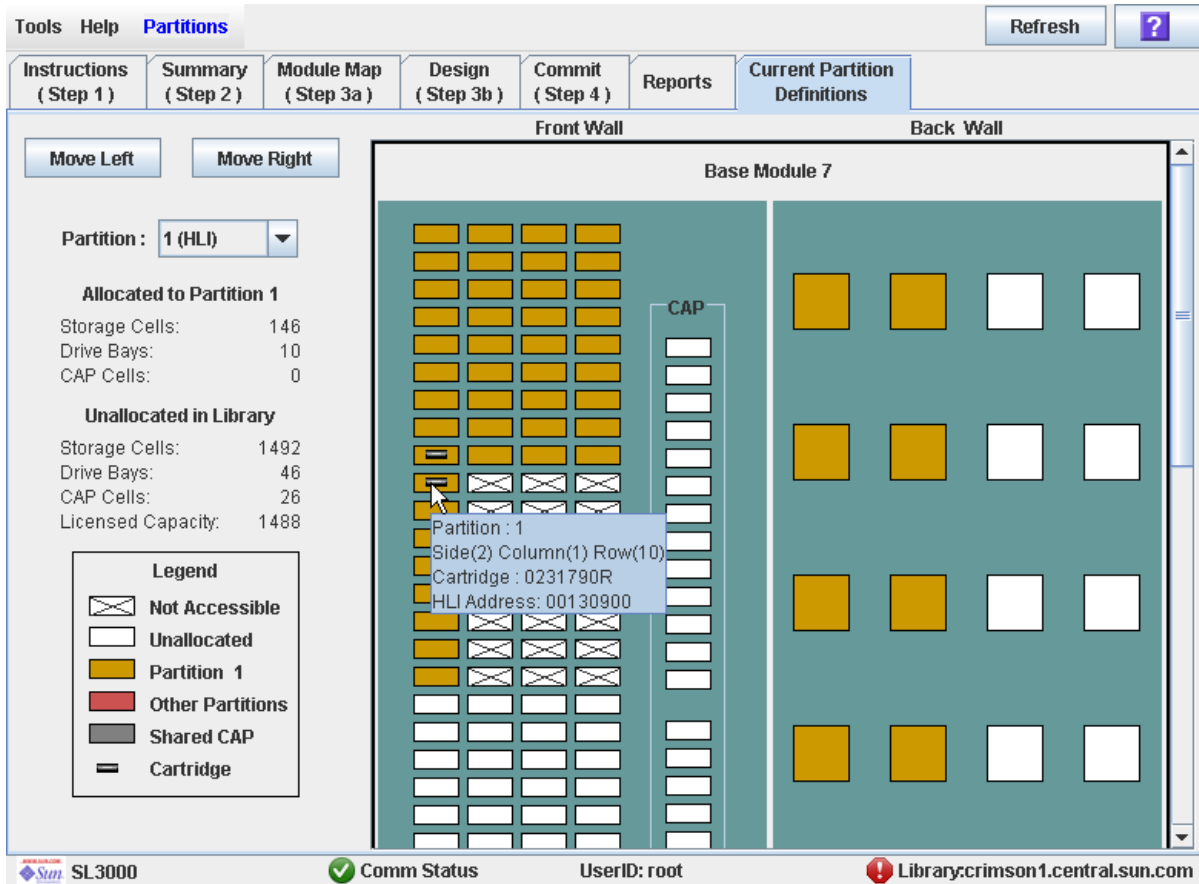

---

# CAP Operation Tasks

<b>Task</b>	<b>Page</b>
<a href="#">Associate an FC-SCSI Partition to Its Shared CAPs</a>	324
<a href="#">Enter Cartridges Into a Partition</a>	326
<a href="#">Eject Cartridges From a Partition</a>	327
<a href="#">Remove a Partition-CAP Association</a>	328
<a href="#">Override a CAP Reservation</a>	329

## ▼ Associate an FC-SCSI Partition to Its Shared CAPs

Use this procedure to associate an FC-SCSI partition to its shared rotational or AEM CAPs. You must use this procedure prior to entering or ejecting cartridges from an FC-SCSI partition if BOTH of the following conditions are true:

- The partition shares one or more CAPs with other partitions, and
- the FC-SCSI host application does not use CAP reservations and prevent/allow commands.

---

**Note** – This procedure should not be used for HLI partitions because HLI host applications always use CAP reservations. If you use this procedure for HLI partitions, the CAP will be made unavailable to ACSLS and HSC hosts.

---

---

**Note** – This procedure is not necessary for dedicated FC-SCSI CAPs because a partition always has ownership of its dedicated CAPs.

---

---

**Note** – AEM CAPs are subject to the same partitioning rules and restrictions as rotational CAPs. Throughout this section, the term “CAP” refers to both types of CAPs.

---

This procedure gives the partition exclusive ownership of its shared CAPs until you explicitly remove the association. See [“Remove a Partition-CAP Association” on page 328](#) for details.



1. Select Tools > Shared CAP Assignment.

The Shared CAP Assignment screen appears.

Tools Help **Shared CAP Assignment** Apply Refresh ?

Partition and CAP Assignment Two Step Process:

1. Select the partitions that you wish to have CAPs assigned to
2. Click 'Apply' to make the CAP assignment



Select	Partition Name	Partition ID	Connection Type	PEM	DEM	Base	PEM
<input type="checkbox"/>	1	1	scsi		X		
<input checked="" type="checkbox"/>	2	2	scsi		X	X	

Shared CAP Assignment Rules:

1. If the partition is grayed out but not selected, then either:
  - a. No CAPs have been assigned to the partition
  - b. Another partition who shares the same CAP has that CAP in use
  - c. CAP ownership by another partition has been assumed by default due to a cartridge being moved to the CAP
  - d. The corresponding partition is of type HLI
2. To successfully assign a partition to its CAP(s), the partition must be able to gain exclusive access to the CAPs that are assigned to it.
3. CAP Assignments do not persist across library changes for any of the following :
  - a. CAP Resets
  - b. Door Opens
  - c. Library Reboots
  - d. Partition Changes

◆ Note: If any of these activities have been performed and the assignment is not present, please reassign CAPs using this screen.

SL3000 Comm Status UserID: root Library:crimson20.stortek.com

2. Click the checkbox of the partitions into which you want to enter cartridges. See “Shared CAP Assignment” on page 399 for details on these screen fields.

3. Click Apply.

The CAP Confirm popup appears.

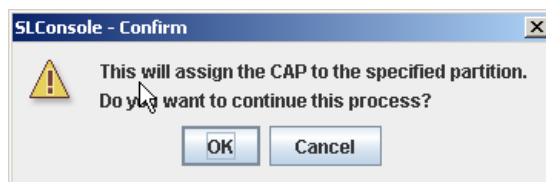

4. Click OK.

5. Perform the enter or eject operation. See one of the following procedures for details:

- “Enter Cartridges Into a Partition” on page 326
- “Eject Cartridges From a Partition” on page 327

## ▼ Enter Cartridges Into a Partition

Use this procedure to enter or bulk load cartridges into one or more partitions. Partitions can use only the rotational or AEM CAPs allocated to them.

---

**Note** – If you are entering cartridges into an FC-SCSI partition that has one or more shared rotational or AEM CAPs and the host application does not use CAP reservations and prevent/allow commands, you must associate the partition to its CAPs before beginning this procedure. See [“Associate an FC-SCSI Partition to Its Shared CAPs”](#) for details. Failure to do this may cause the CAP to remain locked and may prevent the partition from acquiring ownership of the CAP.

---

1. **Follow the steps in one of the following procedures, depending on whether you are using a rotational or AEM CAP:**
  - [“Enter Cartridges Through a Rotational CAP”](#) on page 141
  - [“Bulk Load Cartridges Through an AEM CAP”](#) on page 143
2. **At the completion of the procedure, the CAP reservation is released, as follows:**
  - If you initiated this procedure from an HLI host or an FC-SCSI host that uses CAP reservations, the host removes the reservation, making the CAP available to other partitions.
  - If prior to performing this procedure you performed a manual partition-CAP association, you can now remove the association if the partition is finished with the CAP. See [“Remove a Partition-CAP Association”](#) for details.
  - If the FC-SCSI partition uses a dedicated CAP, the CAP remains unlocked and reserved to the partition.

## ▼ Eject Cartridges From a Partition

Use this procedure to eject or bulk unload cartridges from a partitioned library. Partitions can use only the rotational or AEM CAPs allocated to them.

---

**Note** – If you are entering cartridges into an FC-SCSI partition that has one or more shared rotational or AEM CAPs and the host application does not use CAP reservations and prevent/allow commands, you must associate the partition to its CAPs before beginning this procedure. See [“Associate an FC-SCSI Partition to Its Shared CAPs”](#) for details. Failure to do this may cause the CAP to remain locked and may prevent the partition from acquiring ownership of the CAP.

---

1. **Follow the steps in one of the following procedures, depending on whether you are using a rotational or AEM CAP:**
  - [“Eject Cartridges Through a Rotational CAP”](#) on page 142
  - [“Bulk Unload Cartridges Through an AEM CAP”](#) on page 145
2. **At the completion of the procedure, the CAP reservation is released, as follows:**
  - If you initiated this procedure from an HLI host or an FC-SCSI host that uses CAP reservations, the host removes the reservation, making the CAP available to other partitions.
  - If prior to performing this procedure you performed a manual partition-CAP association, you can now remove the association if the partition is finished with the CAP. See [“Remove a Partition-CAP Association”](#) for details.
  - If the FC-SCSI partition uses a dedicated CAP, the CAP remains unlocked and reserved to the partition.

## ▼ Remove a Partition-CAP Association

Use this procedure after completing an enter or eject operation if you have previously associated the partition to its shared rotational or AEM CAPs. This procedure removes the partition-CAP associations previously set, making the shared CAPs available to other partitions.

---

**Note** – AEM CAPs are subject to the same partitioning rules and restrictions as rotational CAPs. Throughout this section, the term “CAP” refers to both types of CAPs.

---

**1. Select Tools > Shared CAP Assignment.**

The **Shared CAP Assignment** screen appears.

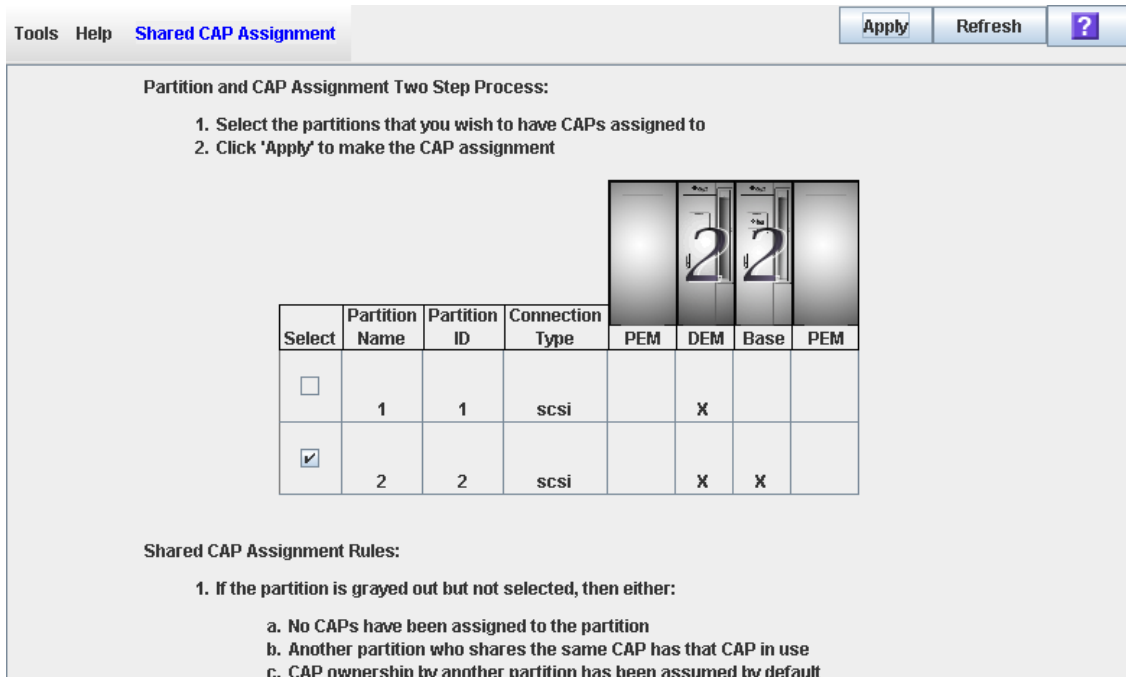

**2. Clear the checkbox of the partitions with the CAP associations. See “Shared CAP Assignment” on page 399 for details on these screen fields.**

**3. Click Apply.**

The **CAP Confirm** popup appears.

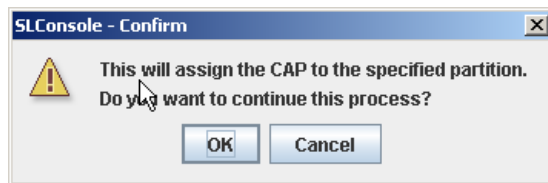

**4. Click OK.**

## ▼ Override a CAP Reservation

Use this procedure when a partition has reserved a shared rotational or AEM CAP but the reservation cannot be released through the ACSLS or HSC host.

---

**Note** – This topic applies to partitioned libraries only. If a library is not partitioned, CAP reservations must always be released through ACSLS or HSC. See the ACSLS or HSC documentation for details.

---

---

**Note** – You must follow all steps in this procedure. If you do not complete the procedure, the CAP could be left unavailable to all partitions, and/or cartridges assigned to one partition could be entered into another partition.

---

---

**Note** – AEM CAPs are subject to the same partitioning rules and restrictions as rotational CAPs. Throughout this section, the term “CAP” refers to both types of CAPs.

---

1. **Select Tools > Diagnostics.**
2. **Expand the CAP Folder, and click the CAP whose reservation you want to override (unreserve).**

---

**Note** – AEM CAPs are identified as follows: column “-31” for a left AEM CAP, and column “31” for a right AEM CAP.

---

3. Click the Unreserve tab.

The **Unreserve** screen appears, identifying the partition that has reserved the CAP.

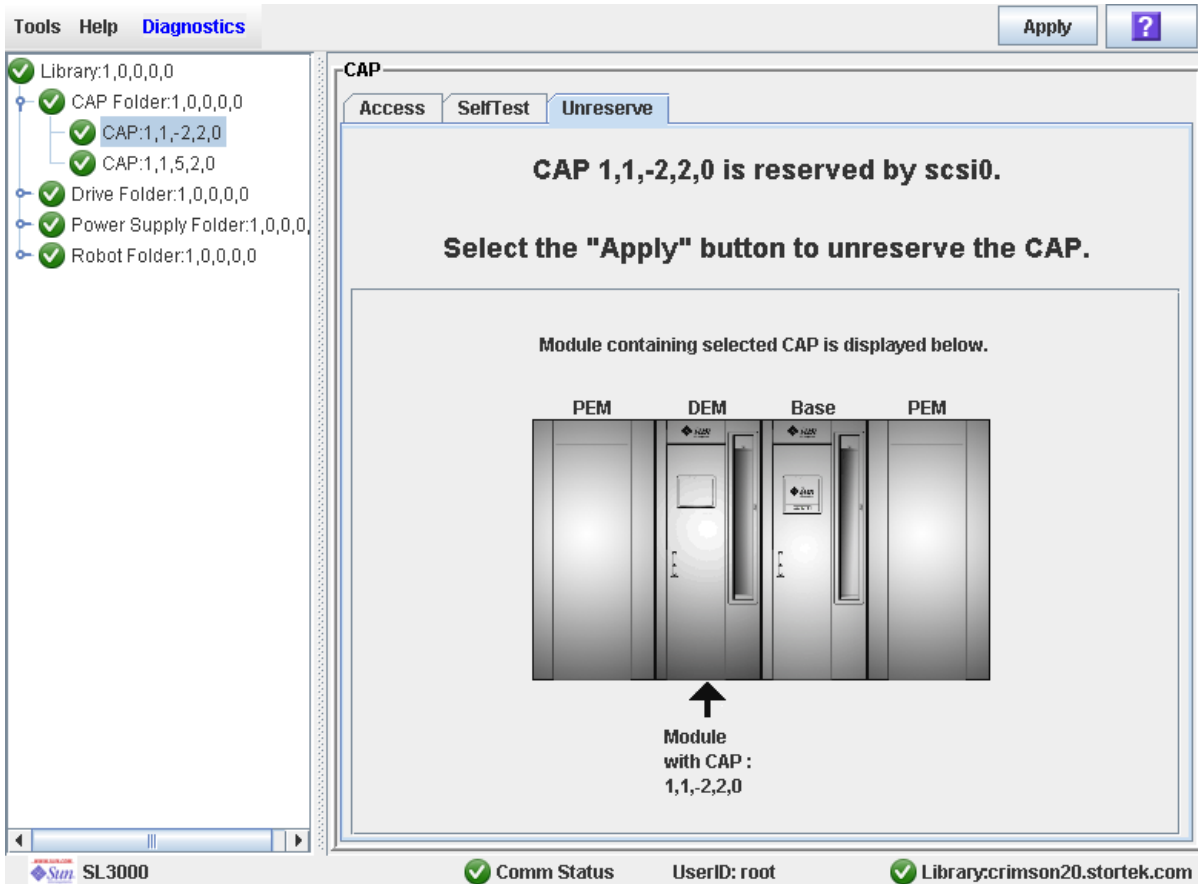

4. Click Apply to override the reservation.

The **Unreserve Confirm** popup appears, indicating “This will remove the reservation from the designated host...”

- Click **OK** to continue with the override operation. The library removes the CAP reservation and sets the CAP user to “default,” which makes the CAP unavailable to all partitions.
- Click **Cancel** to cancel the override operation and return to [Step 3](#).

5. If the CAP is locked, unlock it at the SL Console. See “[Unlock a CAP or AEM Access Door](#)” on page 134 for the detailed procedure.

6. Push the CAP button to open the CAP.

- If it is empty, proceed to [Step 8](#).
- If it contains cartridges, remove them all.

7. Label the cartridges with the partition ID displayed in [Step 3](#).

8. Push the CAP button to close the CAP.

The CAP closes and locks automatically, and the CAP button light turns off.

The library audits the CAP to verify that it is empty. It then sets the CAP status to “unreserved,” which makes the CAP available to all partitions it is allocated to.

---

**Note** – You might need to refresh the CAP display to see the new CAP status.

---

9. **Contact a person responsible for managing the removed cartridges to determine their disposition. If they are to be re-entered into the library, they must be entered into the correct partition.**

## Partition Screen Reference

This section includes detailed descriptions of all SL Console partition screens, arranged by screen navigation path. For example,

**Partitions—Summary (Step 2)—Add Connection** indicates the screen accessed by clicking **Tools** and then **Partitions** from the Menu Bar, and then clicking the **Summary (Step 2)** tab, and then the **Add Connection** button.

---

**Note** – Only the [Partitions—Current Partition Definitions](#) screen is available on the local operator panel. The remaining screens can be accessed only from the standalone SL Console or the Web-launched SL Console.

---

Partition Screens are organized into the following categories:

- [“Partition Summary Screens” on page 333](#)
- [“Partition Design and Commit Screens” on page 353](#)
- [“Partition Report Screens” on page 379](#)
- [“Partition CAP Operation Screens” on page 398](#)

---

**Note** – The partition **Summary (Step 2)** and **Design (Step 3b)** screens, and all associated popups, give you a dynamic workspace to design your library partitions. All partition configuration information is automatically saved to the partition workspace in SL Console memory and retained for the duration of your SL Console session. This allows you to switch among partition views and leave and return to the partition screens any number of times without losing your configuration changes.

---

---

**Caution** – Information in the SL Console partition workspace is saved to the library controller database only through the **Commit (Step 4)** screen. If your SL Console session ends or you refresh the workspace data before you have committed your updates through the **Commit (Step 4)** screen, you will lose any partition changes you have made through the **Summary (Step 2)** and **Design (Step 3b)** screens and all associated popups.

---



---

# Partition Summary Screens

[Partitions—Instructions \(Step 1\)](#)

[Partitions—Summary \(Step 2\)](#)

[Partitions—Summary \(Step 2\)—Add Connection](#)

[Partitions—Summary \(Step 2\)—Delete Connection](#)

[Partitions—Summary \(Step 2\)—Modify Connection](#)

[Partitions—Summary \(Step 2\)—Add Partition](#)

[Partitions—Summary \(Step 2\)—Delete Partition](#)

[Partitions—Summary \(Step 2\)—Modify Partition](#)

# Partitions—Instructions (Step 1)

## Sample Screen

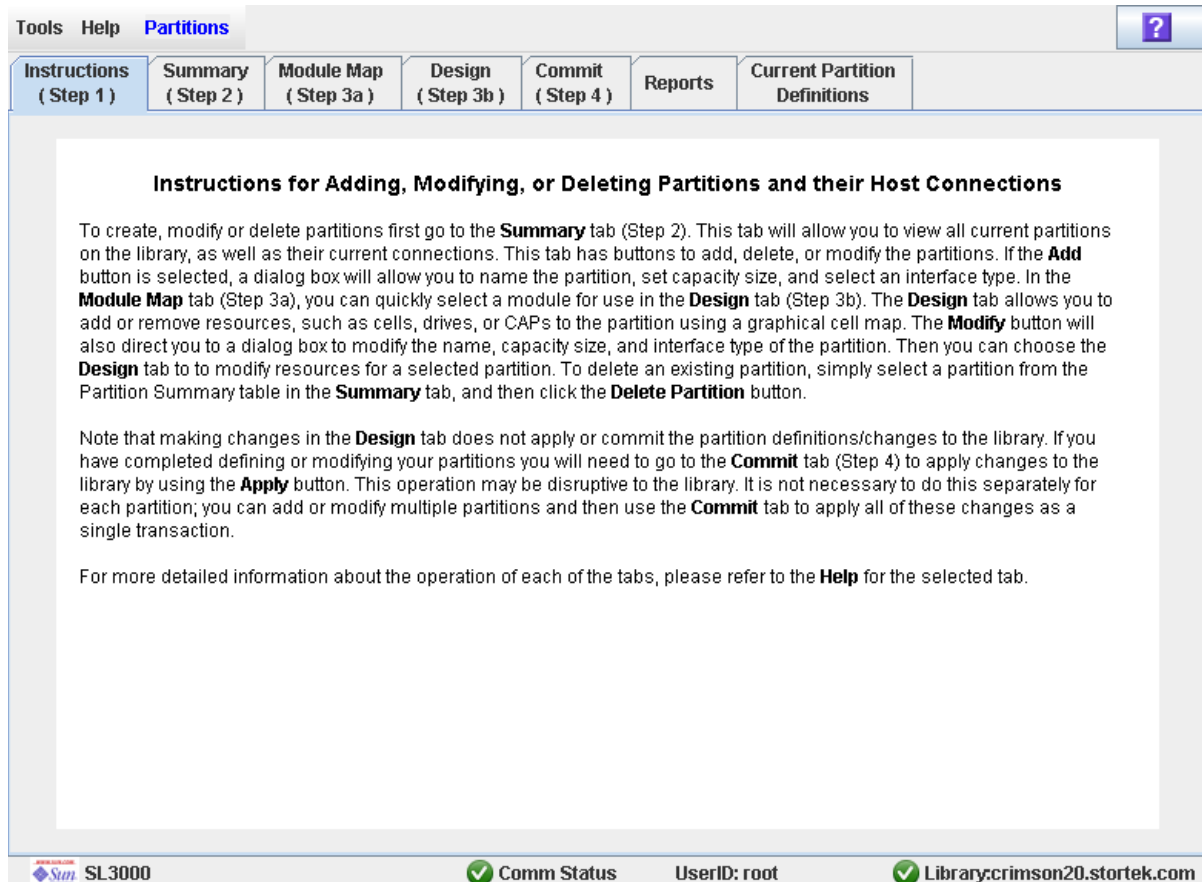

## Description

Displays instructions for using the partition screens.

---

**Note** – This screen appears automatically the first time you select **Tools > Partitions** during an SL Console login session.

---

## Screen Fields

None

## Buttons

? (Help)

Click to display online help for the screen.

## See Also

- [Partitions—Summary \(Step 2\)](#)
- [Partitions—Design \(Step 3b\)](#)
- [Partitions—Commit \(Step 4\)](#)
- [Partitions—Reports](#)

## Partitions—Summary (Step 2)

### Sample Screen

**Total Library Resources**

Storage Cells: 3071  
 Drive Bays: 24  
 CAPs: 5  
 AEMs: 2  
 CAP cells: 130  
 AEM cells: 468  
 Licensed Capacity: 3000

**Resources Allocated**

Storage Cells: 107  
 Drive Bays: 16  
 CAPs: 1  
 AEMs: 1  
 CAP cells: 26  
 AEM cells: 234  
 Licensed Capacity: 107

**Resources Unallocated**

Storage Cells: 2964  
 Drive Bays: 8  
 CAPs: 4  
 AEMs: 1  
 CAP cells: 104  
 AEM cells: 234  
 Licensed Capacity: 2893

**Partition Allocation Summary**

Partition Number	Storage Cells	Drive Bays	CAPs	AEMs	CAP+AEM Cells	%Licensed Capacity
1	63	8	0	0	0	2.10%
2	44	8	1	1	260	1.47%

**Details For Partition 2**

Name: Partition 2  
 Interface Type: HLI

NOTE: Users cannot specify the connections for the HLI partitions.

**Connections**

Initiator (WWPN)	Target Port	LUN

### Description

Displays summary information for the library and, optionally, a selected partition.

Also includes buttons that allow you to initiate any of the following activities:

- Add a new partition
- Delete a partition from the library
- Modify partition summary information

---

**Note** – The following buttons are available for FC-SCSI host-partition connections only. HLI host-partition connections are configured through the host library management software (HSC or ACSLS), not through the SL Console. See the HSC or ACSLS documentation for details.

---

- Add a new host-partition connection
- Delete a host-partition connection
- Modify the configuration of a host-partition connection

## Screen Fields

### *Partition Summary*

#### **Partition Number**

Display only.

ID assigned to the partition. IDs can range from 1–8.

#### **Storage Cells**

Display only.

Total number of storage cells allocated to this partition.

#### **Drive Bays**

Display only.

Total number of tape drives allocated to this partition.

#### **CAPs**

Display only.

Total number of rotational CAPs allocated to this partition; this number represents whole CAPs, not individual CAP cells.

#### **AEMs**

Display only.

Total number of AEMs allocated to this partition; this number represents whole AEMs, not individual AEM cells.

#### **CAP+AEM Cells**

Display only.

Total number of individual rotational and AEM CAP cells allocated to this partition.

#### **%Licensed Capacity**

Display only.

Percentage of the library's licensed capacity that has been allocated to this partition.  
Calculated as:

$$(\text{partition}) \text{ Allocated Storage Cells} / (\text{total library}) \text{ Licensed Capacity}$$

### *Details for Partition n*

---

**Note** – The following fields display host-partition connection information for the partition currently selected in the Partition Summary table.

---

#### **Name**

Display only.

Name assigned to the selected partition.

#### **Interface Type**

Display only.

Type of interface assigned to the selected host-partition connection. Options are:

- HLI
- FC-SCSI

---

**Note** – The following fields are available for FC-SCSI host-partition connections only.

---

### *Connections*

#### **Initiator (WWPN)**

Display only.

World Wide Port Name of the FC-SCSI host bus adapter (HBA).

#### **Target Port**

Display only.

Port number of the SL3000 library controller. This entry is always "0".

#### **LUN**

Display only.

Logical unit number of the library partition on the host. This entry must be unique on the host.

### *Total Library Resources*

#### **Storage Cells**

Display only.

Total physical capacity of the library.

#### **Drive Bays**

Display only.

Total number of tape drives in the library.

#### **CAPs**

Display only.

Total number of rotational CAPs in the library.

#### **AEMs**

Display only.

Total number of AEMs in the library.

#### **CAP cells**

Display only.

Total number of rotational CAP cells in the library.

#### **AEM cells**

Display only.

Total number of AEM cells in the library.

**Licensed Capacity**

Display only.

Total licensed storage capacity of the library.

*Resources Allocated***Storage Cells**

Display only.

Total number of storage cells allocated to all library partitions in the **Design (Step 3b)** screen.

**Drive Bays**

Display only.

Total number of tape drives allocated to all library partitions.

**CAPs**

Display only.

Total number of rotational CAPs allocated to all library partitions.

**AEMs**

Display only.

Total number of AEMs allocated to all library partitions.

**CAP cells**

Display only.

Total number of rotational CAP cells allocated to all library partitions.

**AEM cells**

Display only.

Total number of AEM cells allocated to all library partitions.

**Licensed Capacity**

Display only.

Total licensed storage capacity assigned to all library partitions through the **Add Partition** or **Modify Partition** screen.

*Resources Unallocated***Storage Cells**

Display only.

Total number of storage cells in the library that are not allocated to any partition.

**Drive Bays**

Display only.

Total number of tape drives in the library that are not allocated to any partition.

**CAPs**

Display only.

Total number of rotational CAPs in the library that are not allocated to any library partition.

**AEMs**

Display only.

Total number of AEMs in the library that are not allocated to any library partition.

**CAP cells**

Display only.

Total number of rotational CAP cells in the library that are not allocated to any partition.

**AEM cells**

Display only.

Total number of AEM cells in the library that are not allocated to any partition.

**Licensed Capacity**

Display only.

Total licensed storage capacity not assigned to any library partition through the **Add Partition** or **Modify Partition** screen. Calculated as:

(total library) **Licensed Capacity** – (allocated) **Licensed Capacity**

## Buttons

**Refresh**

Click to refresh the SL Console partition workspace with current data from the library controller database. All uncommitted partition changes you have made during this SL Console login session will be discarded. The **Partition Refresh** popup appears, prompting you to confirm the refresh.

**? (Help)**

Click to display online help for the screen.

**Add Partition**

Click to add a new partition. The [Partitions—Summary \(Step 2\)—Add Partition](#) popup appears.

**Delete Partition**

Click to delete the currently selected partition. The [Partitions—Summary \(Step 2\)—Delete Partition](#) popup appears.

**Modify Partition**

Click to modify summary information for the currently selected partition. The [Partitions—Summary \(Step 2\)—Modify Partition](#) popup appears.

---

**Note** – The following buttons are available for FC-SCSI host-partition connections only.

---

**Add Connection**

Click to add a new host connection to the currently selected partition. The [Partitions—Summary \(Step 2\)—Add Connection](#) popup appears.



**Delete Connection**

Click to delete the currently selected host-partition connection. The [Partitions—Summary \(Step 2\)—Delete Connection](#) popup appears.

**Modify Connection**

Click to modify the configuration of the currently selected host-partition connection. The [Partitions—Summary \(Step 2\)—Modify Connection](#) popup appears.

**See Also**

- [Partitions—Summary \(Step 2\)](#)
- [Partitions—Summary \(Step 2\)—Add Partition](#)
- [Partitions—Summary \(Step 2\)—Delete Partition](#)
- [Partitions—Summary \(Step 2\)—Modify Partition](#)
- [Partitions—Summary \(Step 2\)—Add Connection](#)
- [Partitions—Summary \(Step 2\)—Delete Connection](#)
- [Partitions—Summary \(Step 2\)—Modify Connection](#)
- [Partitions—Module Map \(Step 3a\)](#)
- [Partitions—Design \(Step 3b\)](#)
- [Partitions—Commit \(Step 4\)](#)
- [Partitions—Reports](#)

## Partitions—Summary (Step 2)—Add Connection

### Sample Screen

### Description

Allows you to configure the connection between a host and the selected partition. Each partition can have up to nine host-partition connections, each one having a unique LUN.

---

**Note** – This screen is available for FC-SCSI host-partition connections only. HLI host-partition connections are configured through the host library management software (HSC or ACSLS), not through the SL Console. See the HSC or ACSLS documentation for details.

---

This screen is a popup that appears when you click **Add Connection** on the [Partitions—Summary \(Step 2\)](#) screen.

---

**Caution** – Information in the SL Console partition workspace is saved to the library controller database only through the **Commit (Step 4)** screen. If your SL Console session ends or you refresh the workspace data before you have committed your updates through the **Commit (Step 4)** screen, you will lose any partition changes you have made through the **Summary (Step 2)** and **Design (Step 3b)** screens and all associated popups.

---

### Screen Fields

#### Connections *n*

Display only.

Partition ID of the selected partition.

#### Initiator (WWPN)

Required.

World Wide Port Name of the FC-SCSI host bus adapter (HBA).

Sixteen hexadecimal digits. You can enter upper- or lower-case hex digits, but the display is always shown in all upper-case.

**Target Port**

Display only.

Port number of the SL3000 library controller. This entry is always "0".

**LUN**

Required.

Logical unit number of the library partition on the host. This entry must be unique on the host. You can create up to nine unique LUNs per partition.

---

**Note** – Each initiator connected to the library must have one library partition assigned to LUN 0. When you verify or commit partition configuration changes, the SL Console will notify you if an initiator does not meet this requirement.

---

**Buttons****OK**

Click to update the SL Console partition workspace with the current screen settings and return to the previous screen.

---

**Note** – Clicking this button does not update the library controller database.

---

**Cancel**

Click to discard the current screen settings and return to the previous screen.

**See Also**

- [Partitions—Summary \(Step 2\)](#)

## Partitions—Summary (Step 2)—Delete Connection

### Sample Screen

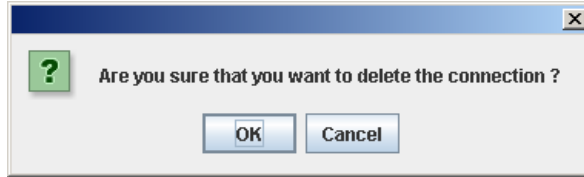

### Description

Allows you to delete the selected host-partition connection.

---

**Note** – This screen is available for FC-SCSI host-partition connections only. HLI host-partition connections are configured through the host library management software (HSC or ACSLS), not through the SL Console. See the HSC or ACSLS documentation for details.

---

This screen is a popup that appears when you click **Delete Connection** on the [Partitions—Summary \(Step 2\)](#) screen.

---

**Caution** – Information in the SL Console partition workspace is saved to the library controller database only through the **Commit (Step 4)** screen. If your SL Console session ends or you refresh the workspace data before you have committed your updates through the **Commit (Step 4)** screen, you will lose any partition changes you have made through the **Summary (Step 2)** and **Design (Step 3b)** screens and all associated popups.

---

### Screen Fields

None

### Buttons

#### OK

Click to update the SL Console partition workspace with the current screen settings and return to the previous screen.

---

**Note** – Clicking this button does not update the library controller database.

---

#### Cancel

Click to discard the current screen settings and return to the previous screen.

## See Also

- [Partitions—Summary \(Step 2\)](#)

## Partitions—Summary (Step 2)—Modify Connection

### Sample Screen

The screenshot shows a 'Modify Connection' dialog box. The title bar reads 'Modify Connection'. The main content area is titled 'Connections 1'. It features three input fields: 'Initiator (WWPN)' containing '200000A0BD080A00', 'Target Port' containing '0', and 'LUN' containing '2'. Below these fields are 'OK' and 'Cancel' buttons.

### Description

Allows you to modify the configuration of the selected host-partition connection.

---

**Note** – This screen is available for FC-SCSI host-partition connections only. HLI host-partition connections are configured through the host library management software (HSC or ACSLS), not through the SL Console. See the HSC or ACSLS documentation for details.

---

This screen is a popup that appears when you click **Modify Connection** on the [Partitions—Summary \(Step 2\)](#) screen.

---

**Caution** – Information in the SL Console partition workspace is saved to the library controller database only through the **Commit (Step 4)** screen. If your SL Console session ends or you refresh the workspace data before you have committed your updates through the **Commit (Step 4)** screen, you will lose any partition changes you have made through the **Summary (Step 2)** and **Design (Step 3b)** screens and all associated popups.

---

### Screen Fields

#### Connections *n*

Display only.  
Partition ID of the selected partition.

#### Initiator (WWPN)

World Wide Port Name of the FC-SCSI host bus adapter (HBA).  
Sixteen hexadecimal digits. You can enter upper- or lower-case hex digits, but the display is always shown in all upper-case.  
The screen displays the value assigned previously. You can leave it as is or make changes.

Target Port

Display only.

Port number of the SL3000 library controller. This entry is always "0".

#### LUN

Required.

Logical unit number of the library partition on the host. This entry must be unique on the host.

---

**Note** – Each initiator connected to the library must have one library partition assigned to LUN 0. When you verify or commit partition configuration changes, the SL Console will notify you if an initiator does not meet this requirement.

---

## Buttons

### OK

Click to update the SL Console partition workspace with the current screen settings and return to the previous screen.

---

**Note** – Clicking this button does not update the library controller database.

---

### Cancel

Click to discard the current screen settings and return to the previous screen.

## See Also

- [Partitions—Summary \(Step 2\)](#)

## Partitions—Summary (Step 2)—Add Partition

### Sample Screen

### Description

Allows you to add a new partition. You can create up to eight partitions, with IDs ranging from 1–8.

This screen is a popup that appears when you click **Add Partition** on the [Partitions—Summary \(Step 2\)](#) screen.

---

**Caution** – Information in the SL Console partition workspace is saved to the library controller database only through the **Commit (Step 4)** screen. If your SL Console session ends or you refresh the workspace data before you have committed your updates through the **Commit (Step 4)** screen, you will lose any partition changes you have made through the **Summary (Step 2)** and **Design (Step 3b)** screens and all associated popups.

---

### Screen Fields

#### Select a Partition ID

Required.

Partition ID you want to add. Options are 1–8.

The pull-down menu displays all available IDs; the default is the next available ID in numerical order.

#### Name

Optional.

Name you want to assign to the partition.

0–60 ASCII characters.

#### Interface Type

Required.

Type of interface to be used for this host-partition connection. Options are:

- HLI
- FC-SCSI



## Buttons

### OK

Click to update the SL Console partition workspace with the current screen settings and return to the previous screen.

---

**Note** – Clicking this button does not update the library controller database.

---

### Cancel

Click to discard the current screen settings and return to the previous screen.

## See Also

- [Partitions—Summary \(Step 2\)](#)

## Partitions—Summary (Step 2)—Delete Partition

### Sample Screen

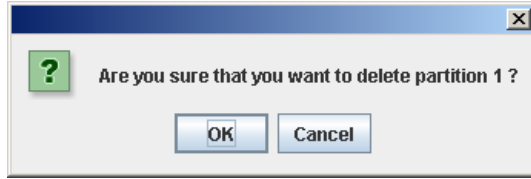

### Description

Allows you to confirm that you want to delete the specified partition. All information for the partition – including host-partition connections, partition boundaries, and partition ID – are deleted from the SL Console partition workspace.

This screen is a popup that appears when you click **Delete Partition** on the [Partitions—Summary \(Step 2\)](#).

---

**Caution** – Information in the SL Console partition workspace is saved to the library controller database only through the **Commit (Step 4)** screen. If your SL Console session ends or you refresh the workspace data before you have committed your updates through the **Commit (Step 4)** screen, you will lose any partition changes you have made through the **Summary (Step 2)** and **Design (Step 3b)** screens and all associated popups.

---

### Screen Fields

None

### Buttons

#### OK

Click to update the SL Console partition workspace with the current screen settings and return to the previous screen.

---

**Note** – Clicking this button does not update the library controller database.

---

#### Cancel

Click to discard the current screen settings and return to the previous screen.

### See Also

- [Partitions—Summary \(Step 2\)](#)

## Partitions—Summary (Step 2)—Modify Partition

### Sample Screen

### Description

Allows you to modify the name or host-partition connection type assigned to the selected partition.

This screen is a popup that appears when you click **Modify Partition** on the [Partitions—Summary \(Step 2\)](#) screen.

---

**Caution** – Information in the SL Console partition workspace is saved to the library controller database only through the **Commit (Step 4)** screen. If your SL Console session ends or you refresh the workspace data before you have committed your updates through the **Commit (Step 4)** screen, you will lose any partition changes you have made through the **Summary (Step 2)** and **Design (Step 3b)** screens and all associated popups.

---

### Screen Fields

#### **Modify Partition *n***

Display only.

ID of the partition you want to modify.

#### **Name**

Required.

Name you want to assign to the partition.

0–60 ASCII characters.

The screen displays the value assigned previously. You can leave it as is or make changes.

#### **Interface Type**

Type of interface to be used for this host-partition connection. Options are:

- HLI
- FC-SCSI

The screen displays the value assigned previously. You can leave it as is or make changes.

---

**Note** – Changing the interface type can result in the loss of active host connections and shared rotational or AEM CAP allocations. See [“Modify the Interface Type of a Host-Partition Connection” on page 307](#) for details.

---

## Buttons

### OK

Click to update the SL Console partition workspace with the current screen settings and return to the previous screen.

---

**Note** – Clicking this button does not update the library controller database.

---

### Cancel

Click to discard the current screen settings and return to the previous screen.

## See Also

- [Partitions—Summary \(Step 2\)](#)

---

# Partition Design and Commit Screens

[Partitions—Design \(Step 3b\)](#)

[Partitions—Design \(Step 3b\) - AEMs Only](#)

[Partitions—Design \(Step 3b\)—Verify Results](#)

[Partitions—Commit \(Step 4\)](#)

[Partitions—Commit \(Step 4\)—Confirm Apply](#)

[Partitions—Current Partition Definitions](#)

## Partitions—Module Map (Step 3a)

### Sample Screen

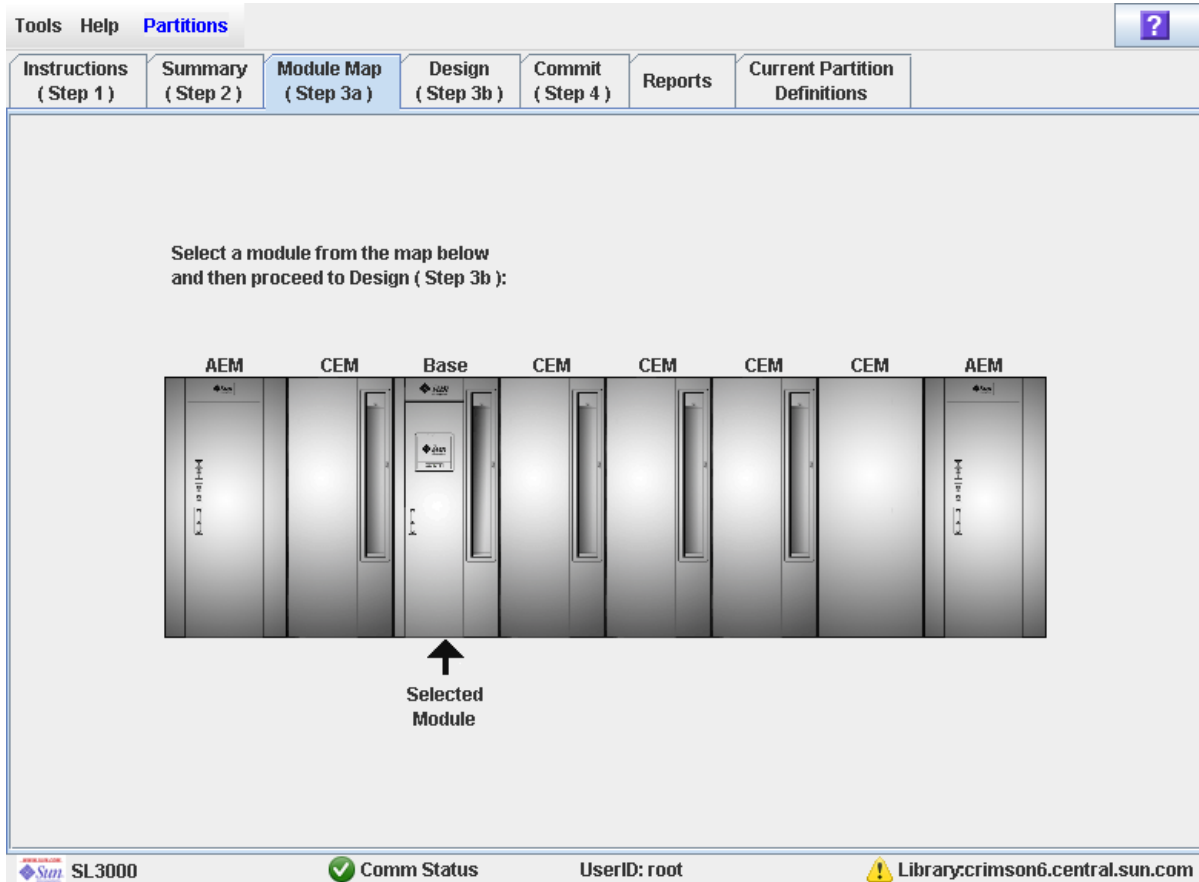

### Description

Allows you to select the library module for which you want to define partition boundaries.

### Screen Fields

#### Select a module from the map below

Required.

The screen displays an illustration of the library's actual module configuration. This information is taken directly from the library controller database.

Click the module for which you want to design a partition, then click the **Design (Step 3b)** tab.

## Buttons

### ? (Help)

Click to display online help for the screen.

### See Also

- [Partitions—Design \(Step 3b\)](#)
- [Partitions—Design \(Step 3b\) - AEMs Only](#)

## Partitions—Design (Step 3b)

**Note** – This section describes the Design (Step 3b) screens for Base, Drive, and CEM modules. For AEM modules, see [“Partitions—Design \(Step 3b\) – AEMs Only” on page 362.](#)

### Sample Screen

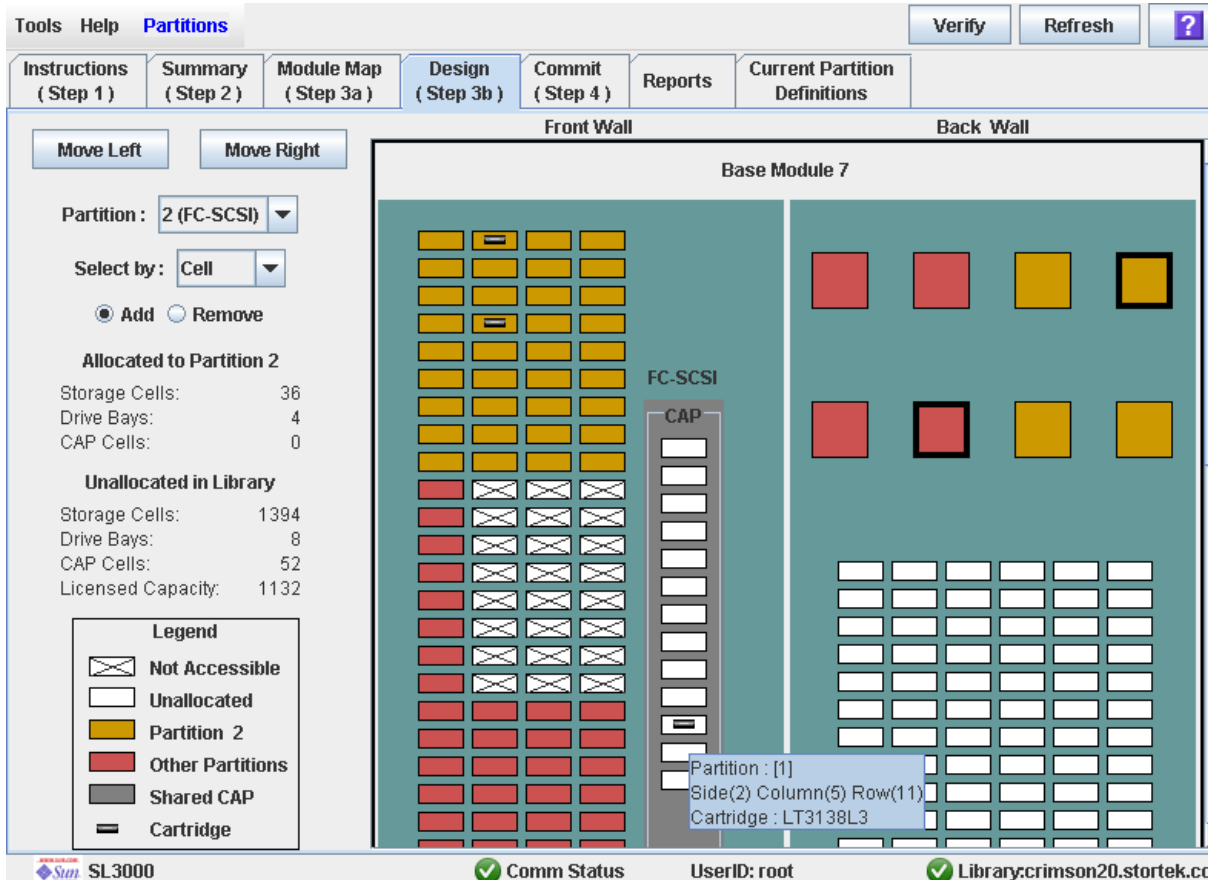

### Description

Allows you to define partition boundaries by selecting the resources (storage cells, tape drives, or rotational CAPs) you want to include in the partition. You can use any of the following methods to add or remove resources from a partition (see [“Library Map” on page 360](#) for detailed instructions):

- Select individual cells or groups of cells
- Select an entire column within a library module (top to bottom)
- Select a side within a library module (front or back)
- Select an entire library module



---

**Note** – This screen is available only if partitions have been defined for the library through the [Partitions—Summary \(Step 2\)—Add Partition](#) screen.

---

**Caution** – Changing partition boundaries can result in orphaned cartridges and data that could be lost. See [“Orphaned Cartridges in Partitioned Libraries” on page 273](#) for details.

---

**Note** – The partition **Summary (Step 2)** and **Design (Step 3b)** screens, and all associated popups, give you a dynamic workspace to design your library partitions. All partition configuration information is automatically saved to the partition workspace in SL Console memory and retained for the duration of your SL Console session. This allows you to switch among partition views and leave and return to the partition screens any number of times without losing your configuration changes.

---

**Caution** – Information in the SL Console partition workspace is saved to the library controller database only through the **Commit (Step 4)** screen. If your SL Console session ends or you refresh the workspace data before you have committed your updates through the **Commit (Step 4)** screen, you will lose any partition changes you have made through the **Summary (Step 2)** and **Design (Step 3b)** screens and all associated popups.

---

## Screen Fields

### Partition

Required.

Partition to which you want to add or remove resources (storage cells, tape drives, or rotational CAPs).

The pull-down menu displays all valid partition IDs for the library. It also identifies their host interface type (FC-SCSI or HLI). If no partition IDs have been defined, the menu is blank.

---

**Note** – When you select a partition, the screen is automatically updated to display data for that partition from the SL Console partition workspace.

---

### Select by

Required.

Indicates the method you want to use for defining partition boundaries. Options are:

- Cell – Select individual or rectangular groups of resources.
- Column – Select all resources within a column.
- Side – Select all resources, except the CAP, within one side of a library module.
- Module – Select all resources, except the CAP, within a library module.

---

**Note** – You must select either **Add** or **Remove**.

---

**Add**

Required.

Indicates you want to add resources to the partition. You will only be able to click unallocated resources on the library map.

**Remove**

Required.

Indicates you want to remove resources from the partition. You will only be able to click allocated resources on the library map.

*Allocated to Partition n*

---

**Note** – The data in these fields is automatically updated from the SL Console partition workspace when you select a partition.

---

**Storage Cells**

Display only.

Total number of storage cells allocated to the selected partition, based on the currently defined partition boundaries.

**Drive Bays**

Display only.

Total number of tape drives allocated to the selected partition, based on the currently defined partition boundaries.

**CAP Cells**

Display only.

Total number of rotational and AEM CAP cells allocated to the selected partition, based on the currently defined partition boundaries.

*Unallocated in Library*

---

**Note** – The data in these fields is automatically updated from the SL Console partition workspace when you select a partition.

---

**StorageCells**

Display only.

Total number of storage cells in the library that are not allocated to any partition.

**Drive Bays**

Display only.

Total number of tape drives in the library that are not allocated to any partition.

**CAP Cells**

Display only.

Total number of rotational and AEM CAP cells in the library that are not allocated to any partition.

### Licensed Capacity

---

**Note** – This field appears only if the library has unallocated licensed capacity. If allocations exceed licensed capacity (an oversubscription situation), the **Oversubscription** field appears.

---

Display only.

Total licensed capacity of the library that is not allocated to any partition. Calculated as:

Total licensed capacity – Total allocated storage cells

### Oversubscription

---

**Note** – This field appears only if allocations exceed licensed capacity (an oversubscription situation). If the library has unallocated licensed capacity, the **Licensed Capacity** field appears.

---

Display only.

Total licensed capacity of the library that has been exceeded through partition allocations. Calculated as:

Total allocated storage cells – Total licensed capacity

You must remove the excess allocations before you can commit your changes through the **Commit (Step 4)** screen.

### Legend

Legend for the library map. The state of each library resource (storage cell, tape drive, or rotational CAP cell) is indicated as follows:

- Not Accessible (white and x-ed out). Resource is not accessible to any partition. Following are some possible reasons:
  - Storage cells have been configured for diagnostic cartridges.
  - Storage cells are not included in the library's licensed capacity.
- Unallocated. Resource is currently not allocated to any partition and therefore available to the selected partition.
- Partition *n* (gold). Resource is allocated to the selected partition, partition *n*.
- Other Partitions (red). Resource is allocated to another partition and therefore NOT available to the selected partition.
- Shared CAP (gray background). CAP has been assigned to at least one partition. The host interface type assigned to the CAP (HLI or FC-SCSI) is displayed.
- Cartridge (cartridge icon). Resource contains a tape cartridge.
- Drive slots with installed drives are outlined with a thick border. Empty drive slots have a narrow border.

### *Library Map*

Graphical representation of the current library configuration. Initial display for the current SL Console login session is from the library controller database, then the display reflects data from the SL Console partition workspace as you modify partition configurations. The display includes the following information:

- Type of module currently displayed (base module, drive expansion module, or parking expansion module)
- Numeric module ID (1–12)
- Host-partition connection type of a shared CAP (FC-SCSI or HLI)
- Location of all resources (storage cells, tape drives, rotational CAP cells) within the library

---

**Note** – Move the cursor over any resource to display a tooltip of detailed information about the cell or drive, its partition assignment, and the identity of any resident cartridge.

---



---

**Note** – If no partition IDs have been defined, the library map is display only.

---

Use the library map to modify the boundaries of the selected partition. Depending on whether you have clicked the **Add** or **Remove** radio button, all selected resources are either added to or removed from the partition.

Depending on your choice in the **Select by** field, you can perform any of the following actions.

- Select by cell – Select individual or groups of resources. Resources in a partition do not need to be adjacent to one another.
  - To select an individual resource, double-click it.
  - To select a rectangular group of resources, click the cell or drive at one corner of the rectangle, and then click the cell or drive diagonally opposite.
- Select by column – Select an entire column within the module. Columns in a partition do not need to be adjacent to one another. To select a column, click any resource within the column.
- Select by side – Select an entire side within a module, except the CAP. Sides in a partition do not need to be adjacent to one another. To select one side of a library module, click any resource in that side.
- Select by module – Select an entire module, except the CAP. Modules in a partition do not have to be adjacent to one another. To select a library module, click any resource in that module.

## Buttons

### **Move Left**

Click to display the library module directly to the left of the one currently displayed. This button is grayed out if there is no module to the left.

### **Move Right**

Click to display the library module directly to the right of the one currently displayed. This button is grayed out if there is no module to the right.

### Verify

Click to verify partition configuration changes you have made during this SL Console login session. The **Tools > Partitions—Design (Step 3b)—Verify Results** popup appears, indicating whether there are any orphaned cartridges or other errors in the current partition configuration.

---

**Note** – This procedure verifies only one partition at a time. If you need to verify multiple partitions, you must repeat this procedure separately for each partition.

---

---

**Note** – This verification is performed on the current partition configuration in the SL Console partition workspace only. It does not verify current partition boundaries against the library controller database; therefore it cannot identify configuration conflicts that may arise due to other users performing cartridge movements or library configuration changes—through the command line interface, other SL Console sessions, or host applications—at the same time you have made partition changes.

---

### Refresh

Click to refresh the SL Console partition workspace with current data from the library controller database. All uncommitted partition changes you have made during this SL Console login session will be discarded. The **Partition Refresh** popup appears, prompting you to confirm the refresh.

### ? (Help)

Click to display online help for the screen.

### See Also

- [Partitions—Summary \(Step 2\)](#)
- [Partitions—Module Map \(Step 3a\)](#)
- [Partitions—Design \(Step 3b\) - AEMs Only](#)
- [Partitions—Design \(Step 3b\)—Verify Results](#)
- [Partitions—Commit \(Step 4\)](#)
- [Partitions—Current Partition Definitions](#)
- [Partitions—Reports](#)

## Partitions—Design (Step 3b) – AEMs Only

**Note** – This section describes the Design (Step 3b) screen for AEM modules only. For Base, Drive, and CEM modules, see [“Partitions—Design \(Step 3b\)”](#) on page 356.

**Note** – This screen is available only if the library configuration includes one or more AEMs.

### Sample Screen

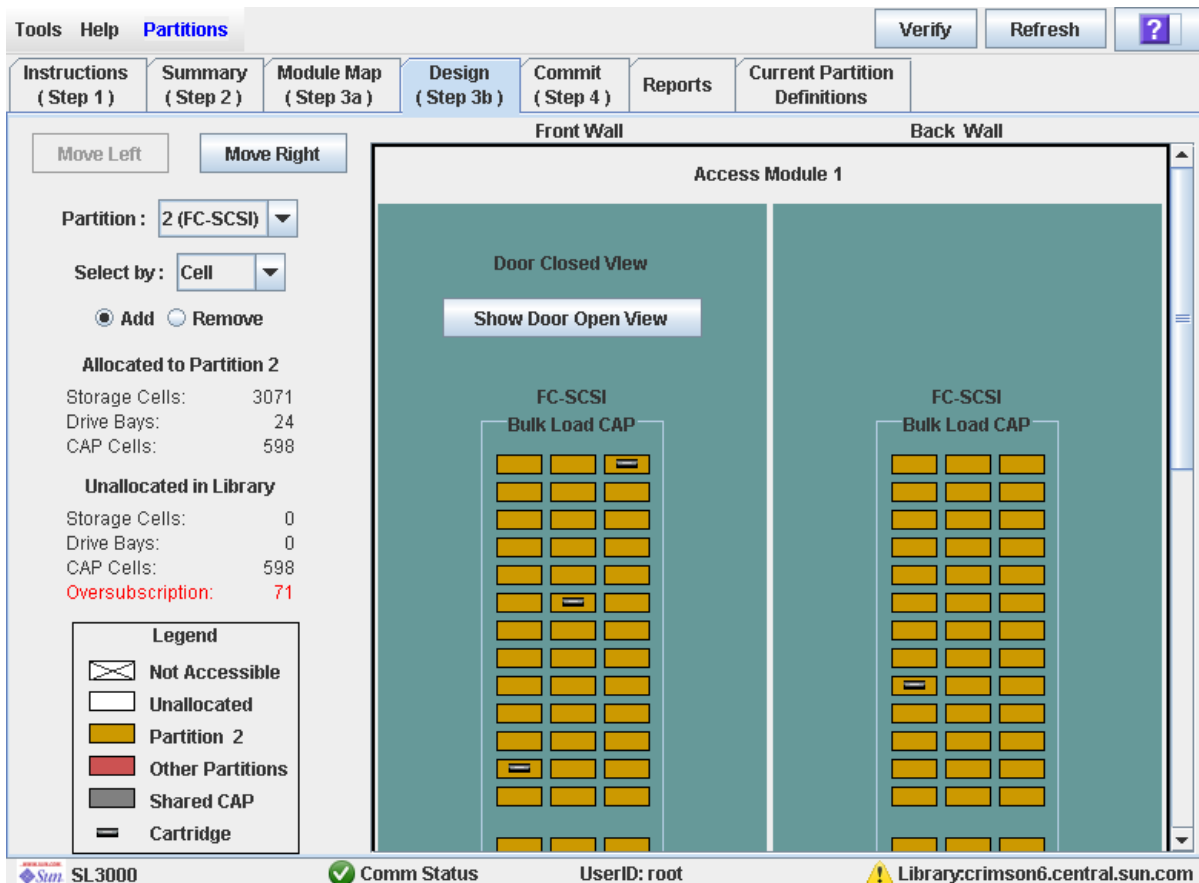

### Description

Allows you to define partition boundaries by allocating all cells in an AEM to a partition. As with rotational CAPs, multiple partitions can share an AEM CAP, if the partitions have the same host interface type (HLI or FC-SCSI).

**Note** – This screen is available only if partitions have been defined for the library through the [Partitions—Summary \(Step 2\)—Add Partition](#) screen.

---

**Caution** – Changing partition boundaries can result in orphaned cartridges and data that could be lost. See [“Orphaned Cartridges in Partitioned Libraries”](#) on page 273 for details.

---

---

**Note** – The partition **Summary (Step 2)** and **Design (Step 3b)** screens, and all associated popups, give you a dynamic workspace to design your library partitions. All partition configuration information is automatically saved to the partition workspace in SL Console memory and retained for the duration of your SL Console session. This allows you to switch among partition views and leave and return to the partition screens any number of times without losing your configuration changes.

---

---

**Caution** – Information in the SL Console partition workspace is saved to the library controller database only through the **Commit (Step 4)** screen. If your SL Console session ends or you refresh the workspace data before you have committed your updates through the **Commit (Step 4)** screen, you will lose any partition changes you have made through the **Summary (Step 2)** and **Design (Step 3b)** screens and all associated popups.

---

## Screen Fields

### Partition

Required.

Partition to which you want to add or remove AEM CAP cells.

The drop-down menu displays all valid partition IDs for the library. It also identifies their host interface type (FC-SCSI or HLL). If no partition IDs have been defined, the menu is blank.

---

**Note** – When you select a partition, the screen is automatically updated to display data for that partition from the SL Console partition workspace.

---

### Select by

Required.

Indicates the method you want to use for defining partition boundaries. Regardless of the option you choose, all cells within the AEM will be selected at once.

---

**Note** – You must select either **Add** or **Remove**.

---

### Add

Required.

Indicates you want to add the AEM to the partition. This option is valid only if the AEM is currently unallocated.

### Remove

Required.

Indicates you want to remove the AEM from the partition. This option is valid only if the AEM is currently allocated.

### *Allocated to Partition *n**

---

**Note** – The data in these fields is automatically updated from the SL Console partition workspace when you select a partition.

---

#### **Storage Cells**

Display only.

Total number of storage cells allocated to the selected partition, based on the currently defined partition boundaries.

#### **Drive Bays**

Display only.

Total number of tape drives allocated to the selected partition, based on the currently defined partition boundaries.

#### **CAP Cells**

Display only.

Total number of rotational and AEM CAP cells allocated to the selected partition, based on the currently defined partition boundaries.

### *Unallocated in Library*

---

**Note** – The data in these fields is automatically updated from the SL Console partition workspace when you select a partition.

---

#### **Storage Cells**

Display only.

Total number of storage cells in the library that are not allocated to any partition.

#### **Drive Bays**

Display only.

Total number of tape drives in the library that are not allocated to any partition.

#### **CAP Cells**

Display only.

Total number of rotational and AEM CAP cells in the library that are not allocated to any partition.

#### **Licensed Capacity**

---

**Note** – This field appears only if the library has unallocated licensed capacity. If allocations exceed licensed capacity (an oversubscription situation), the **Oversubscription** field appears.

---



Display only.

Total licensed capacity of the library that is not allocated to any partition. Calculated as:

Total licensed capacity – Total allocated storage cells

### Oversubscription

---

**Note** – This field appears only if allocations exceed licensed capacity (an oversubscription situation). If the library has unallocated licensed capacity, the **Licensed Capacity** field appears.

---

Display only.

Total licensed capacity of the library that has been exceeded through partition allocations. Calculated as:

Total allocated storage cells – Total licensed capacity

You must remove the excess allocations before you can commit your changes through the **Commit (Step 4)** screen.

### Legend

Legend for the library map. The state of each AEM CAP cell is indicated as follows:

- Not Accessible (white and x-ed out). Resource is not accessible to any partition. Following are some possible reasons:
  - Storage cells have been configured for diagnostic cartridges.
  - Storage cells are not included in the library's licensed capacity.
- Unallocated. Resource is currently not allocated to any partition and therefore available to the selected partition.
- Partition *n* (gold). Resource is allocated to the selected partition, partition *n*.
- Other Partitions (red). Resource is allocated to another partition and therefore NOT available to the selected partition.
- Shared AEM CAP (gray background). AEM CAP has been assigned to at least one partition. The host interface type assigned to the AEM CAP (HLI or FC-SCSI) is displayed.
- Cartridge (cartridge icon). Resource contains a tape cartridge.

### AEM Map

Graphical representation of the current AEM configuration. Initial display for the current SL Console login session is from the library controller database, then the display reflects data from the SL Console partition workspace as you modify partition configurations. The display includes the following information:

- Type of module currently displayed; for AEMs, this is always "Access Module".
- Numeric module ID (1–12)
- Current module view indicator ("Door Closed View" or "Door Open View")
- Host interface type of the partition(s) to which the AEM is allocated (FC-SCSI or HLI)
- CAP type; for AEMs, this is always "Bulk Load CAP".

- Location of all storage cells within the AEM

---

**Note** – Move the cursor over any resource to display a tooltip of detailed information about the cell or drive, its partition assignment, and the identity of any resident cartridge.

---

---

**Note** – If no partition IDs have been defined, the library map is display only.

---

Use the library map to modify the partition allocation of the AEM. Depending on whether you have clicked the **Add** or **Remove** radio button, the entire AEM is either added to or removed from the partition.

## Buttons

### Move Left

Click to display the library module directly to the left of the one currently displayed. This button is grayed out if there is no module to the left.

### Move Right

Click to display the library module directly to the right of the one currently displayed. This button is grayed out if there is no module to the right.

---

**Note** – The “Door Closed View” is the default AEM view. You can use the next two buttons to toggle between the alternate views.

---

### Show Door Open View

Click to display the layout of the AEM CAP cells as if the AEM access door were open and you are looking directly at the interior of the AEM.

### Show Door Closed View

Click to show display the layout of the AEM CAP cells as if the AEM access door were closed and you are “looking through” the front access door panel to the interior of the AEM.

### Verify

Click to verify partition configuration changes you have made during this SL Console login session. The **Tools > Partitions—Design (Step 3b)—Verify Results** popup appears, indicating whether there are any orphaned cartridges or other errors in the current partition configuration.

---

**Note** – This procedure verifies only one partition at a time. If you need to verify multiple partitions, you must repeat this procedure separately for each partition.

---

---

**Note** – This verification is performed on the current partition configuration in the SL Console partition workspace only. It does not verify current partition boundaries against the library controller database; therefore it cannot identify configuration conflicts that may arise due to other users performing cartridge movements or library configuration changes—through the command line interface, other SL Console sessions, or host applications—at the same time you have made partition changes.

---

### Refresh

Click to refresh the SL Console partition workspace with current data from the library controller database. All uncommitted partition changes you have made during this SL Console login session will be discarded. The **Partition Refresh** popup appears, prompting you to confirm the refresh.

### ? (Help)

Click to display online help for the screen.

### See Also

- [Partitions—Summary \(Step 2\)](#)
- [Partitions—Module Map \(Step 3a\)](#)
- [Partitions—Design \(Step 3b\)](#)
- [Partitions—Design \(Step 3b\)—Verify Results](#)
- [Partitions—Commit \(Step 4\)](#)
- [Partitions—Current Partition Definitions](#)
- [Partitions—Reports](#)

## Partitions—Design (Step 3b)—Verify Results

### Sample Screen

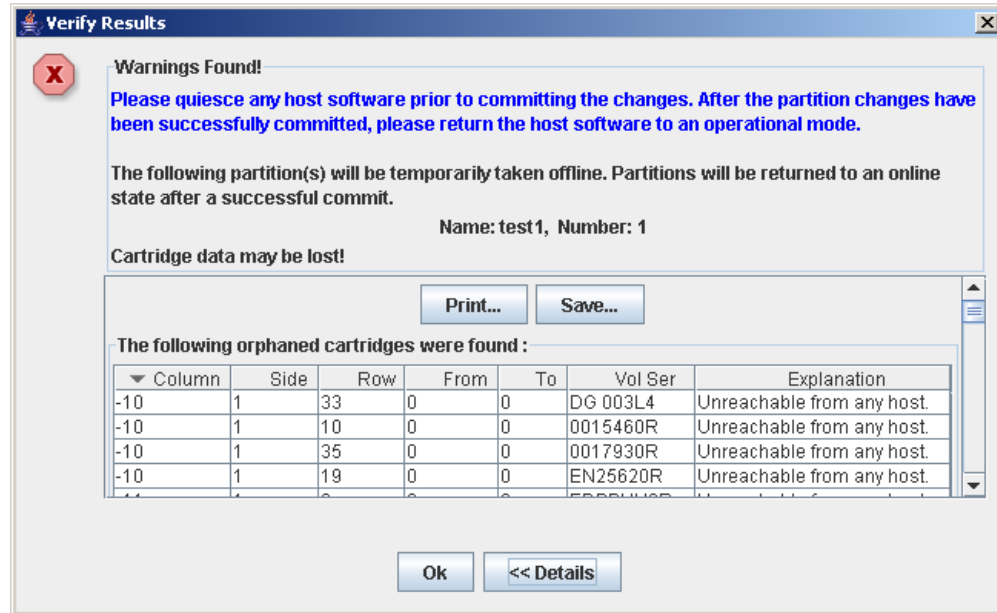

### Description

Displays a list of configuration errors in the current SL Console partition workspace.

This screen is a popup that appears when you click **Verify Results** on the [Partitions—Design \(Step 3b\)](#) screen.

Possible errors include:

- A partition has orphaned cartridges. See [“Orphaned Cartridges in Partitioned Libraries”](#) for details.
- Library resources have been removed from a partition.
- A host-partition connection does not have a partition assigned to LUN 0 (applies to FC-SCSI connections only).

If any of these error conditions are present, the screen initially displays summary warning messages. You can view detailed messages by clicking the **Details** button.

It is recommended that you resolve all errors before committing the data to the library controller database.

Optionally, you can print the screen data or save it to a comma-separated file.

---

**Note** – The partition **Summary (Step 2)** and **Design (Step 3b)** screens, and all associated popups, give you a dynamic workspace to design your library partitions. All partition configuration information is automatically saved to the partition workspace in SL Console memory and retained for the duration of your SL Console session. This allows you to switch among partition views and leave and return to the partition screens any number of times without losing your configuration changes.

---

**Caution** – Information in the SL Console partition workspace is saved to the library controller database only through the **Commit (Step 4)** screen. If your SL Console session ends or you refresh the workspace data before you have committed your updates through the **Commit (Step 4)** screen, you will lose any partition changes you have made through the **Summary (Step 2)** and **Design (Step 3b)** screens and all associated popups.

---

## Screen Fields

---

**Note** – The screen fields are the same as those displayed in the [Partitions—Commit \(Step 4\)—Confirm Apply](#) popup.

---

### Warnings found

Display only.

Summary error messages regarding the partition configuration.

### The library is oversubscribed. Please unallocate *nnn* storage cells.

Display only.

Indicates that the total partition allocations currently exceed the library's licensed capacity. *nnn* is the number of cells you must remove from partition allocations. The **Apply** button on the **Commit (Step 4)** screen remains deactivated until the total allocated cells is within the library's licensed capacity.

### The following hosts will need re-audited

Display only.

World Wide Port Names (WWPNs) of any hosts that should re-audit their library partition. This may be because library resources have been deleted from the partition.

### The following hosts do not have Lun 0 set

Display only.

World Wide Port Names (WWPNs) of any hosts that have not defined any library partitions as LUN 0 on the host. This error applies to FC-SCSI host-partition connections only.

### The following orphaned cartridges were found

Display only.

Detailed information regarding all orphaned cartridges in the current partition configuration. Includes library, rail, column, side, and row location of the cartridge, cartridge volume serial number (VOLID), and probable causes and explanations why the cartridge is orphaned.

## Buttons

### Print

Click to print the report on a selected printer.

### Save

Click to save the report to a designated comma-separated text file (.csv extension). Comma-separated files can be opened by a variety of spreadsheet and database programs.

### OK

Click to cancel the update. The library controller database is not updated, but all partition changes from this login session are retained in the SL Console partition workspace.

### Details

Click to toggle between the expanded and collapsed views of the warning message display.

## See Also

- [Partitions—Design \(Step 3b\)](#)
- [Partitions—Commit \(Step 4\)—Confirm Apply](#)

## Partitions—Commit (Step 4)

### Sample Screen

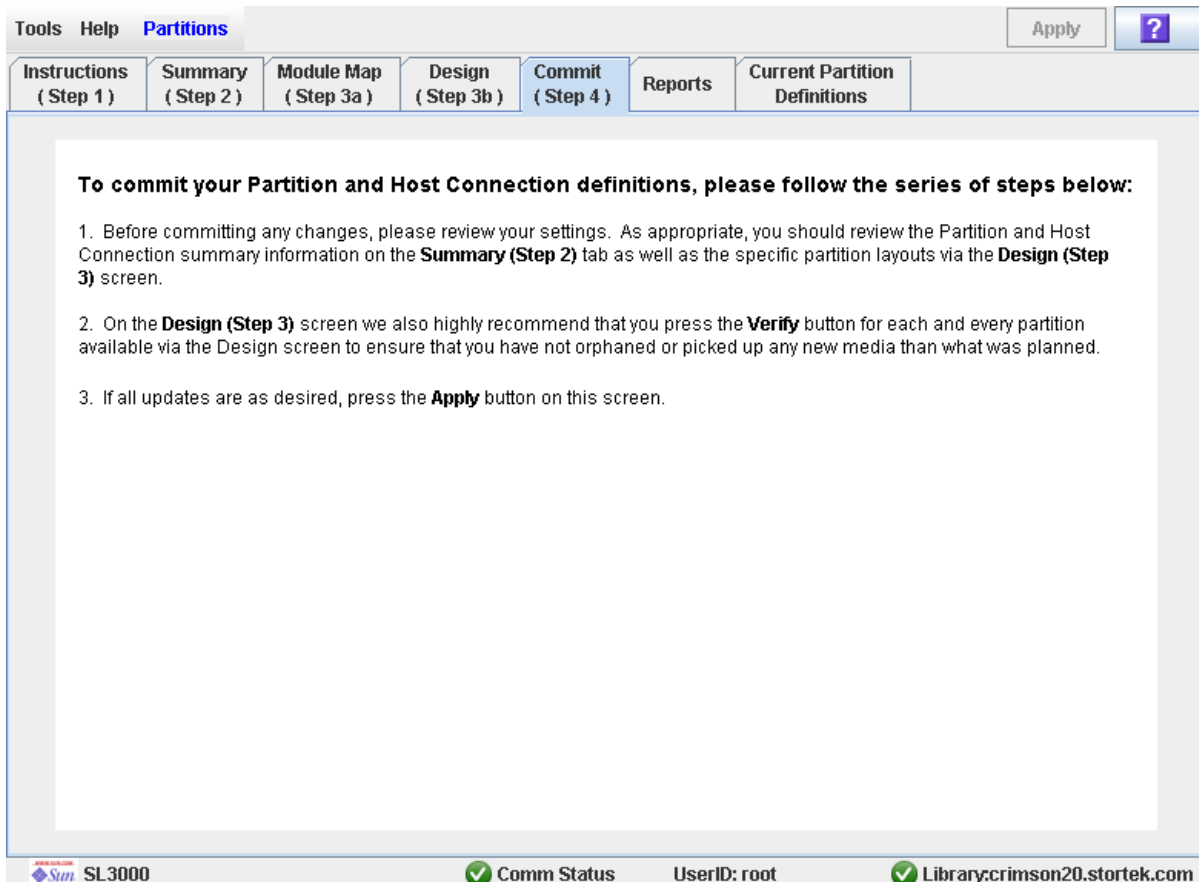

### Description

Allows you to commit all data from the current SL Console partition workspace to the library controller database. The following data will be committed for all partitions:

- Partition summary information
- Host-partition connection configuration information
- Partition boundary details

---

**Caution** – Although partition changes are not disruptive to library hosts, it is recommended that you make the library unavailable to other users before committing your partition workspace changes. Because the SL Console does not validate partition boundaries against the library controller database in real-time, configuration conflicts may arise if you change partition boundaries while other users are performing cartridge movements or library configuration changes. See [“Synchronizing the Display With the Controller Database”](#) on page 36 for details.

---

---

**Caution** – Information in the SL Console partition workspace is saved to the library controller database only through the **Commit (Step 4)** screen. If your SL Console session ends or you refresh the workspace data before you have committed your updates through the **Commit (Step 4)** screen, you will lose any partition changes you have made through the **Summary (Step 2)** and **Design (Step 3b)** screens and all associated popups.

---

---

**Caution** – It is recommended that you follow the [Resolve Orphaned Cartridges](#) procedure before using this screen.

---

---

**Caution** – This screen updates the library controller database with all partition configuration changes you have made during this SL Console session. Failure to use this screen before logging out of the current SL Console session will cause all your library configuration changes to be lost.

---

## Screen Fields

None

## Buttons

### Apply

Click to update the library controller database with the current settings from the SL Console partition workspace. The **Tools > Partitions—Commit (Step 4)—Confirm Apply** popup appears, indicating whether there are any orphaned cartridges or other errors in the current partition configuration.

---

**Note** – This button is grayed out if total partition allocations currently exceed the library's licensed capacity. To activate the button, you must remove storage cells from partition allocations to bring the total allocated cells within the library's licensed capacity.

---

---

**Note** – This button is grayed out if you have not made any changes to the SL Console partition workspace since the last commit.

---

### ? (Help)

Click to display online help for the screen.

## See Also

- [Partitions—Summary \(Step 2\)](#)
- [Partitions—Design \(Step 3b\)](#)
- [Partitions—Design \(Step 3b\)—Verify Results](#)
- [Partitions—Commit \(Step 4\)—Confirm Apply](#)



- [Partitions—Reports](#)

## Partitions—Commit (Step 4)—Confirm Apply

### Sample Screen

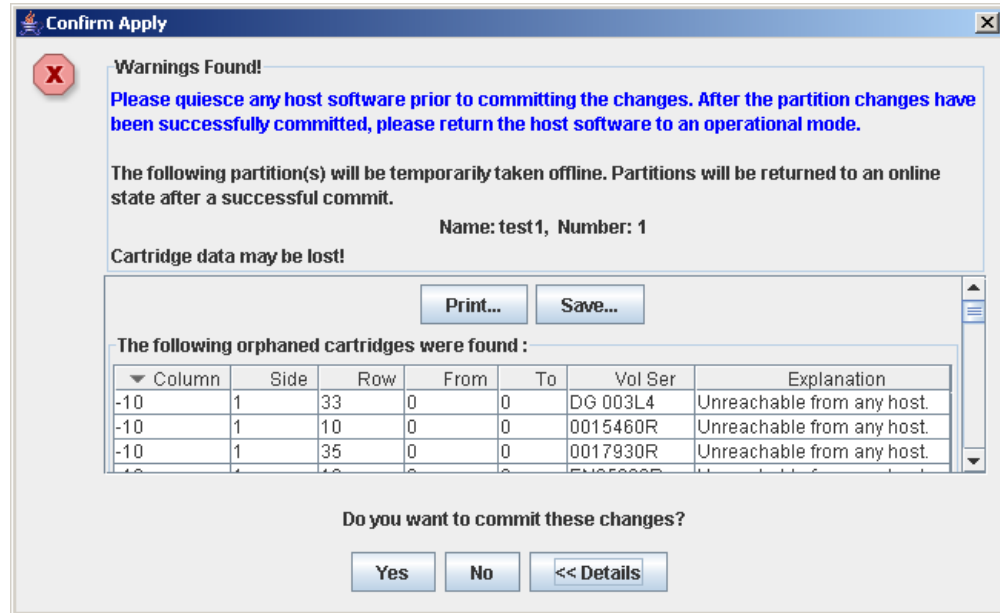

### Description

Displays a list of configuration errors in the current SL Console partition workspace. This screen is a popup that appears when you click **Apply** on the [Partitions—Commit \(Step 4\)](#) screen.

After viewing the error messages, you can commit all data in the SL Console partition workspace to the library controller database by clicking the **Yes** button.

Possible errors include:

- A partition has orphaned cartridges. See [“Orphaned Cartridges in Partitioned Libraries”](#) for details.
- Library resources have been removed from a partition.
- A host-partition connection does not have a partition assigned to LUN 0 (applies to FC-SCSI connections only).

If any of these error conditions are present, the screen initially displays summary warning messages. You can view detailed messages by clicking the **Details** button.

It is recommended that you resolve all errors before committing the data to the library controller database.

Optionally, you can print the screen data or save it to a comma-separated file.

---

**Caution** – Information in the SL Console partition workspace is saved to the library controller database only through the **Commit (Step 4)** screen. If your SL Console session ends or you refresh the workspace data before you have committed your

updates through the **Commit (Step 4)** screen, you will lose any partition changes you have made through the **Summary (Step 2)** and **Design (Step 3b)** screens and all associated popups.

---

## Screen Fields

---

**Note** – The screen fields are the same as those displayed in the [Partitions—Design \(Step 3b\)—Verify Results](#) popup.

---

### Warnings found

Display only.

Summary error messages regarding the partition configuration.

### The library is oversubscribed. Please unallocate *nnn* storage cells.

Display only.

Indicates that the total partition allocations currently exceed the library's licensed capacity. *nnn* is the number of cells you must remove from partition allocations. The **Apply** button on the **Commit (Step 4)** screen remains deactivated until the total allocated cells is within the library's licensed capacity.

### The following hosts will need re-audited

Display only.

World Wide Port Names (WWPNs) of any hosts that should re-audit their library partition. This may be because library resources have been deleted from the partition.

### The following hosts do not have Lun 0 set

Display only.

World Wide Port Names (WWPNs) of any hosts that have not defined any library partitions as LUN 0 on the host. This error applies to FC-SCSI host-partition connections only.

### The following orphaned cartridges were found

Display only.

Detailed information regarding all orphaned cartridges in the current partition configuration. Includes library, rail, column, side, and row location of the cartridge, cartridge volume serial number (VOLID), and probable causes and explanations why the cartridge is orphaned.

## Buttons

### Print

Click to print the report on a selected printer.

### Save

Click to save the report to a designated comma-separated text file (.csv extension). Comma-separated files can be opened by a variety of spreadsheet and database programs.

**Yes**

Click to confirm that you want to update the library controller database with the current settings from the SL Console workspace.

**No**

Click to cancel the update. The library controller database is not updated, but all partition changes from this login session are retained in the SL Console partition workspace.

**Details**

Click to toggle between the expanded and collapsed views of the warning message display.

**See Also**

- [Partitions—Commit \(Step 4\)](#)
- [Partitions—Design \(Step 3b\)—Verify Results](#)

## Partitions—Current Partition Definitions

### Sample Screen

### Description

Displays current partition boundaries and allocations. This is the only Partitions screen that is available on the local operator panel.

---

**Note** – This screen is display only.

---

### Screen Fields

For detailed descriptions of the screen fields, see one of the following sections:

- “Partitions—Design (Step 3b)” on page 356, for Base, Drive, and CEM modules
- “Partitions—Design (Step 3b) – AEMs Only” on page 362, for AEMs

## Buttons

### **Refresh**

Click to refresh the display with current data from the library controller database.

### **? (Help)**

Click to display online help for the screen.

## See Also

- [Partitions—Design \(Step 3b\)](#)
- [Partitions—Design \(Step 3b\) – AEMs Only](#)

---

# Partition Report Screens

[Partitions—Reports](#)

[Partitions—Reports—Cartridge Cell and Media Summary](#)

[Partitions—Reports—Host Connections Summary](#)

[Partitions—Reports—Orphaned Cartridge Report](#)

[Partitions—Reports—Partition Details](#)

[Partitions—Reports—Partition Summary](#)

# Partitions—Reports

## Sample Screen



## Description

Allows you to select one of the following library partition reports:

- Cartridge Cell and Media Summary
- Host Connections Summary
- Orphaned Cartridge Report
- Partition Details
- Partition Summary

---

**Note** – The partition reports display data saved to the library controller database. If you have made partition configuration changes without committing the changes to the library controller through the **Commit (Step 4)** screen, the data in these reports will differ from data shown on the partition **Summary (Step 2)** and **Design (Step 3b)** screens.

---



## Screen Fields

### Please select a report to display

Required.

Click the report you want to display. The drop-down menu lists all available library partition reports.

## Buttons

### Refresh

Click to refresh the SL Console partition workspace with current data from the library controller database. All uncommitted partition changes you have made during this SL Console login session will be discarded. The **Partition Refresh** popup appears, prompting you to confirm the refresh.

### ? (Help)

Click to display online help for the screen.

## See Also

- [Partitions—Summary \(Step 2\)](#)
- [Partitions—Design \(Step 3b\)](#)
- [Partitions—Commit \(Step 4\)](#)
- [Partitions—Reports—Cartridge Cell and Media Summary](#)
- [Partitions—Reports—Host Connections Summary](#)
- [Partitions—Reports—Orphaned Cartridge Report](#)
- [Partitions—Reports—Partition Details](#)
- [Partitions—Reports—Partition Summary](#)

# Partitions—Reports—Cartridge Cell and Media Summary

## Sample Screen

Tools Help **Partitions** ?

Instructions ( Step 1 ) Summary ( Step 2 ) Module Map ( Step 3a ) Design ( Step 3b ) Commit ( Step 4 ) **Reports** Current Partition Definitions

NOTE: The reports in this menu reflect only the current partition definitions stored on the library. Any changes to the partition definitions made in the Design tab will be reflected in the reports only after they are committed.

Cartridge Cell and Media Summary ▼

Cell and Media Summary as of 7/23/09 1:27 PM

▼ Column	Side	Row	Partition ID	Partition Name	Element Type	Vol Ser	Cell Status	HLI/SCSI Address
-11	1	1	1	one	CELL		Active	2000
-11	1	2	1	one	CELL	1188900R	Active	2001
-11	1	3	1	one	CELL	LT3145L3	Active	2002
-11	1	4	1	one	CELL	DVT018T1	Active	2003
-11	1	5	1	one	CELL		Active	2004
-11	1	6	1	one	CELL		Active	2005
-11	1	7	1	one	CELL		Active	2006
-11	1	8	1	one	CELL		Active	2007
-11	1	9	1	one	CELL		Active	2008
-11	1	10	1	one	CELL		Active	2009
-11	1	11	1	one	CELL		Active	2010
-11	1	12	1	one	CELL		Active	2011
-11	1	13	1	one	CELL		Active	2012
-11	1	14	1	one	CELL		Active	2013

Print... Save To File...

SL3000 Comm Status UserID: root Library:crimson9.central.sun.com

## Description

Displays detailed information about all library resources (storage cells, tape drives, and rotational or AEM CAP cells) and any stored cartridges.

---

**Note** – The partition reports display data saved to the library controller database. If you have made partition configuration changes without committing the changes to the library controller through the **Commit (Step 4)** screen, the data in these reports will differ from data shown on the partition **Summary (Step 2)** and **Design (Step 3b)** screens.

---



---

**Note** – AEM CAP cells are identified as follows: left AEM CAP cells are in columns “-33” to “-31”; right AEM CAP cells are in columns “31” to “33”.

---

---

**Note** – You can modify the layout and display of this screen. See [“Modifying the Screen Layout” on page 36](#) for details.

---

Optionally, you can print the screen data or save it to a comma-separated file.

## Screen Fields

### Column

Display only.

Column number where the library resource is located. Column location is referenced from the left edge of the Base Module. “+1” is to the right; “-1” is to the left.

### Side

Display only.

Module side where the library resource is located. “1” is the back wall; “2” is the front wall.

### Row

Display only.

Row number where the library resource is located. Rows are numbered consecutively from the top down, with row “1” at the top.

### Partition ID

Display only.

Partition ID to which the library resource is allocated, if applicable.

### Partition Name

Display only.

Name of the partition to which the library resource is allocated, if applicable. If the library has no defined partitions, “Non-Partitioned Library” is displayed.

### Element Type

Display only.

Type of library resource. Options are:

- CAP (rotational or AEM)
- CELL
- DRIVE

### Vol Ser

Display only.

Volume serial number (VOLID) of the cartridge resident in the library resource, if applicable.

### Cell Status

Display only.

Capacity status of the library resource. Applies to storage cells only. Options are:

- Active – Cell is activated for use based on assigned capacity; can be used for cartridge storage.

- Inactive – Cell is not activated for use; cannot be used for cartridge storage.

### HLI/SCSI Address

Display only.

Host address of the library resource. Format of the entry depends on the host-partition connection type (HLI or FC-SCSI).

- HLI – Format is eight digits in the following format. See “[HLI-PRC Address](#)” on [page 272](#) for additional details.

*ll* – Library number; always 0

*pp* – Column number

*rr* – Row number

*cc* – Column number

- FC-SCSI – Format is four digits. See “[Host FC-SCSI Element Address](#)” on [page 271](#) for details.

## Buttons

### Print

Click to print the report on a selected printer.

### Save to File

Click to save the report to a designated comma-separated text file (.csv extension). Comma-separated files can be opened by a variety of spreadsheet and database programs.

### Refresh

Click to refresh the SL Console partition workspace with current data from the library controller database. All uncommitted partition changes you have made during this SL Console login session will be discarded. The **Partition Refresh** popup appears, prompting you to confirm the refresh.

### ? (Help)

Click to display online help for the screen.

## See Also

- [Partitions—Reports—Host Connections Summary](#)
- [Partitions—Reports—Orphaned Cartridge Report](#)
- [Partitions—Reports—Partition Details](#)
- [Partitions—Reports—Partition Summary](#)

# Partitions—Reports—Host Connections Summary

## Sample Screen

Tools Help **Partitions** ?

Instructions (Step 1) Summary (Step 2) Module Map (Step 3a) Design (Step 3b) Commit (Step 4) **Reports** Current Partition Definitions

**NOTE:** The reports in this menu reflect only the current partition definitions stored on the library. Any changes to the partition definitions made in the Design tab will be reflected in the reports only after they are committed.

Host Connections Summary ▼

Host Connections as of 7/23/09 1:34 PM

Partition ID	Partition Name	Connectic Type	Storage Cells	Media in Storage Cells	%Storage Cells w/ Media	Drives	CAP Cells	AEM Cells	Active Cells
1	one	SCSI	793	101	12.74%	16	52	0	793

**Host Connections (HLI Partitions do not have Host Connections)**

Initiator WWPN	Library Controller Port	LUN	Partition ID
11:11:22:22:33:33:44:01	0	0	1
11:11:22:22:33:33:44:02	0	0	1
11:11:22:22:33:33:55:01	0	0	1
11:11:22:22:33:33:55:02	0	0	1
11:11:22:22:33:33:66:01	0	0	2
11:11:22:22:33:33:66:02	0	0	2

Print... Save To File...

SL3000 Comm Status UserID: root Library:crimson9.central.sun.com

## Description

Displays detailed information about all host-partition connections for the library.

**Note** – The partition reports display data saved to the library controller database. If you have made partition configuration changes without committing the changes to the library controller through the **Commit (Step 4)** screen, the data in these reports will differ from data shown on the partition **Summary (Step 2)** and **Design (Step 3b)** screens.

You can modify the layout and display of this screen. See [“Modifying the Screen Layout” on page 36](#) for details.

Optionally, you can print the screen data or save it to a comma-separated file.

## Screen Fields

### *Partitions*

---

**Note** – The screen fields in this section also appear on the [Partitions—Reports—Partition Summary](#) report.

---

#### **Partition ID**

Display only.

ID of the partition (1-8).

#### **Partition Name**

Display only.

Name of the partition.

#### **Connection Type**

Display only.

Type of interface used by the host-partition connection. Options are:

- HLI
- FC-SCSI

#### **Storage Cells**

Display only.

Total number of storage cells allocated to the partition.

#### **Media in Storage Cells**

Display only.

Total number of tape cartridges resident in the partition's storage cells.

#### **% Storage Cells w/ Media**

Display only.

Percentage of storage cells containing tape cartridges. Calculated as **Media in Storage Cells / Storage Cells**.

#### **Drive Bays**

Display only.

Total number of drive bays allocated to the partition.

#### **CAP Cells**

Display only.

Total number of rotational CAP cells allocated to the partition.

#### **AEM Cells**

Display only.

Total number of AEM CAP cells allocated to the partition.

#### **Active Cells**

Display only.

Total storage cell capacity assigned to the partition in the **Add Partition** screen.

### *Host Connections*

#### **Initiator WWPN**

Display only.

World Wide Port Name of an FC-SCSI host bus adapter (HBA) with a connection to the partition.

#### **Library Controller Port**

Display only.

Port number of the SL3000 library controller on the host. This entry is always "0".

#### **LUN**

Display only.

Logical unit number of the library partition on the host.

#### **Partition ID**

Display only.

Partition ID to which the host has a connection.

## Buttons

#### **Print**

Click to print the report on a selected printer.

#### **Save**

Click to save the report to a designated comma-separated text file (.csv extension). Comma-separated files can be opened by a variety of spreadsheet and database programs.

#### **Refresh**

Click to refresh the SL Console partition workspace with current data from the library controller database. All uncommitted partition changes you have made during this SL Console login session will be discarded. The **Partition Refresh** pop-up appears, prompting you to confirm the refresh.

#### **? (Help)**

Click to display online help for the screen.

## See Also

- [Partitions—Reports—Cartridge Cell and Media Summary](#)
- [Partitions—Reports—Orphaned Cartridge Report](#)
- [Partitions—Reports—Partition Details](#)
- [Partitions—Reports—Partition Summary](#)

# Partitions—Reports—Orphaned Cartridge Report

## Sample Screen

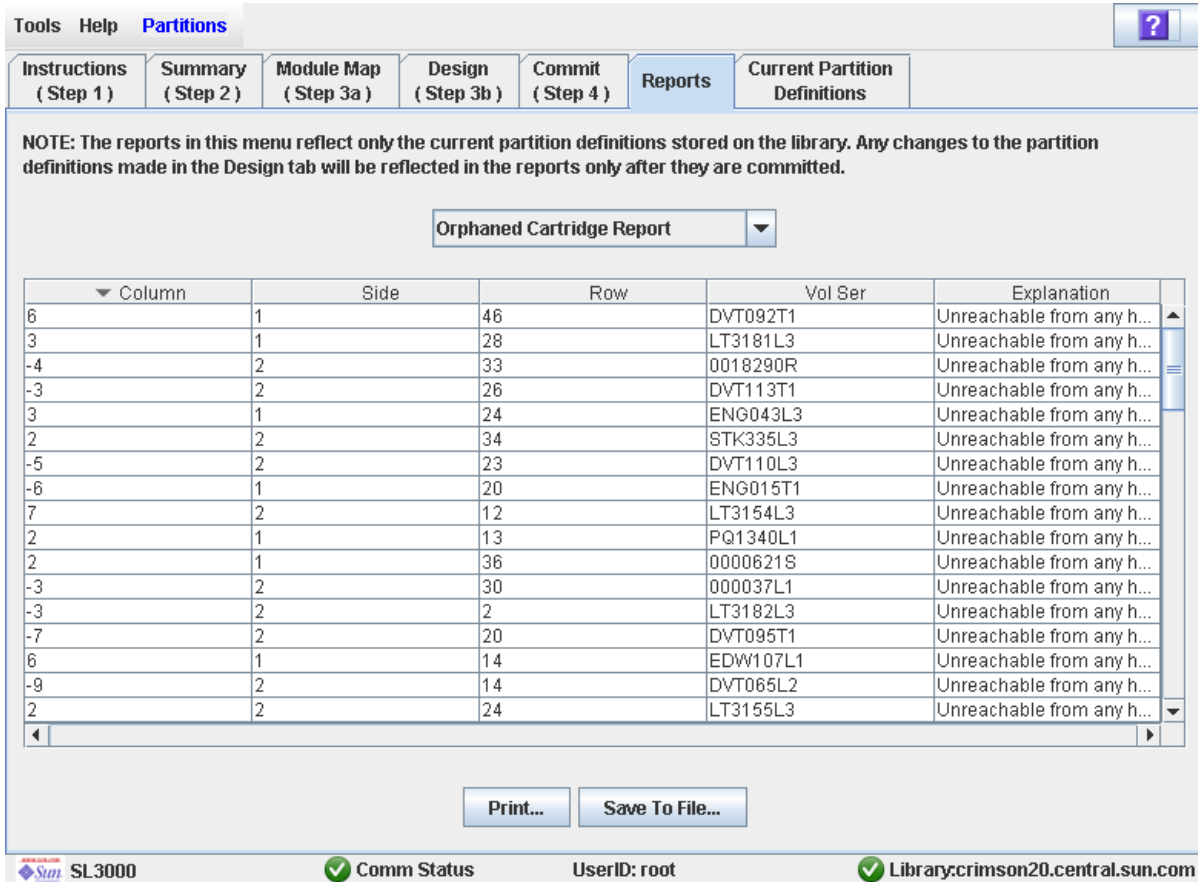

Tools Help **Partitions** ?

Instructions ( Step 1 ) Summary ( Step 2 ) Module Map ( Step 3a ) Design ( Step 3b ) Commit ( Step 4 ) **Reports** Current Partition Definitions

NOTE: The reports in this menu reflect only the current partition definitions stored on the library. Any changes to the partition definitions made in the Design tab will be reflected in the reports only after they are committed.

Orphaned Cartridge Report

Column	Side	Row	Vol Ser	Explanation
6	1	46	DVT092T1	Unreachable from any h...
3	1	28	LT3181L3	Unreachable from any h...
-4	2	33	0018290R	Unreachable from any h...
-3	2	26	DVT113T1	Unreachable from any h...
3	1	24	ENG043L3	Unreachable from any h...
2	2	34	STK335L3	Unreachable from any h...
-5	2	23	DVT110L3	Unreachable from any h...
-6	1	20	ENG015T1	Unreachable from any h...
7	2	12	LT3154L3	Unreachable from any h...
2	1	13	PQ1340L1	Unreachable from any h...
2	1	36	0000621S	Unreachable from any h...
-3	2	30	000037L1	Unreachable from any h...
-3	2	2	LT3182L3	Unreachable from any h...
-7	2	20	DVT095T1	Unreachable from any h...
6	1	14	EDW107L1	Unreachable from any h...
-9	2	14	DVT065L2	Unreachable from any h...
2	2	24	LT3155L3	Unreachable from any h...

Print... Save To File...

SL3000 Comm Status UserID: root Library:crimson20.central.sun.com

## Description

Displays the locations and volume serial numbers (VOLIDs) of all orphaned cartridges in the library. Also identifies why the cartridge is orphaned.

---

**Note** – The partition reports display data saved to the library controller database. If you have made partition configuration changes without committing the changes to the library controller through the **Commit (Step 4)** screen, the data in these reports will differ from data shown on the partition **Summary (Step 2)** and **Design (Step 3b)** screens.

---

You can modify the layout and display of this screen. See [“Modifying the Screen Layout” on page 36](#) for details.

Optionally, you can print the screen data or save it to a comma-separated file.



## Screen Fields

### Column

Display only.

Column number where the orphaned cartridge is located. Column location is referenced from the left edge of the Base Module. "+1" is to the right; "-1" is to the left.

### Side

Display only.

Module side where the orphaned cartridge is located. "1" is the back wall; "2" is the front wall.

### Row

Display only.

Row number where the orphaned cartridge is located. Rows are numbered consecutively from the top down, with row "1" at the top.

### Vol Ser

Display only.

Volume serial number (VOLID) of the orphaned cartridge.

### Explanation

Display only.

Explanation of why the cartridge is orphaned.

Because this report is produced from the library controller database, the only option is:

- Unreachable from any host

## Buttons

### Print

Click to print the report on a selected printer.

### Save

Click to save the report to a designated comma-separated text file (.csv extension). Comma-separated files can be opened by a variety of spreadsheet and database programs.

### Refresh

Click to refresh the SL Console partition workspace with current data from the library controller database. All uncommitted partition changes you have made during this SL Console login session will be discarded. The **Partition Refresh** popup appears, prompting you to confirm the refresh.

### ? (Help)

Click to display online help for the screen.

## See Also

- [Partitions—Reports—Cartridge Cell and Media Summary](#)
- [Partitions—Reports—Host Connections Summary](#)
- [Partitions—Reports—Partition Details](#)
- [Partitions—Reports—Partition Summary](#)

# Partitions—Reports—Partition Details

## Sample Screen

Tools Help **Partitions** ?

Instructions ( Step 1 ) Summary ( Step 2 ) Module Map ( Step 3a ) Design ( Step 3b ) Commit ( Step 4 ) **Reports** Current Partition Definitions

NOTE: The reports in this menu reflect only the current partition definitions stored on the library. Any changes to the partition definitions made in the Design tab will be reflected in the reports only after they are committed.

Partition Details ▼

Partition ID: 1 ▼

Details for Partition 1 as of 12/17/08 3:49 PM

Name	Value
Partition Name	Partition 1
Partition ID	1
Connection Type	HLI
Assigned Cells	390
Available Cells	1058
Occupied Cells	64
Active (Capacity Licensed) Cells	390
Assigned Drive Bays	8
Available Drive Bays	0
Number of Drives	0
Occupied Drives	0
Assigned CAP cells	0
Available CAP cells	52
Occupied CAP cells	0
Assigned AEM cells	0
Available AEM cells	0
Occupied AEM cells	0
% Cell Capacity (Assigned Cells/Total Cells)	20.17%

Print... Save To File...

SL3000 Comm Status UserID: root Library:crimson2.central.sun.com

## Description

Displays detailed information for a selected partition.

---

**Note** – The partition reports display data saved to the library controller database. If you have made partition configuration changes without committing the changes to the library controller through the **Commit (Step 4)** screen, the data in these reports will differ from data shown on the partition **Summary (Step 2)** and **Design (Step 3b)** screens.

---

You can modify the layout and display of this screen. See [“Modifying the Screen Layout” on page 36](#) for details.

Optionally, you can print the screen data or save it to a comma-separated file.

## Screen Fields

### **Partition Name**

Display only.

Name of the partition.

### **Partition ID**

Display only.

ID of the partition (1–8).

### **Connection Type**

Display only.

Type of interface used by the host-partition connection. Options are:

- HLI
- FC-SCSI

### **Assigned Cells**

Display only.

Total number of storage cells allocated to the partition.

### **Available Cells**

Display only.

Total number of storage cells in the library available for allocation to the partition.

### **Occupied Cells**

Display only.

Total number of storage cells in the partition with tape cartridges present.

### **Active (Capacity Licensed) Cells**

Display only.

Total storage cell capacity assigned to the partition in the **Add Partition** screen.

### **Assigned Drive Bays**

Display only.

Total number of drive bays allocated to the partition.

### **Available Drive Bays**

Display only.

Total number of drive bays in the library available for allocation to the partition.

### **Number of Drives**

Display only.

Total number of installed tape drives allocated to the partition.

**Occupied Drives**

Display only.

Total number of installed tape drives in the partition with tape cartridges present.

**Assigned CAP cells**

Display only.

Total number of rotational CAP cells allocated to the partition through dedicated or shared CAPs.

**Available CAP cells**

Display only.

Total number of rotational CAP cells in the library available for allocation to the partition. This number includes all rotational and AEM CAP cells in the following:

- CAPs not allocated to any partition.
- CAPs not currently allocated to this partition, but allocated to other partitions with the same host interface type as this one.

This number excludes all rotational and AEM CAP cells in the following:

- CAPs currently allocated to this partition.
- CAPs allocated to partitions with a different host interface type.

**Occupied CAP cells**

Display only.

Total number of rotational CAP cells in the partition with tape cartridges present.

**Assigned AEM cells**

Display only.

Total number of AEM CAP cells allocated to the partition through dedicated or shared AEMs.

**Available AEM cells**

Display only.

Total number of AEM CAP cells in the library available for allocation to the partition. This number includes all AEM cells in the following:

- AEMs not allocated to any partition.
- AEMs not currently allocated to this partition, but allocated to other partitions with the same host interface type as this one.

This number excludes all AEM cells in the following:

- AEMs currently allocated to this partition.
- AEMs allocated to partitions with a different host interface type.

**Occupied AEM cells**

Display only.

Total number of AEM CAP cells in the partition with tape cartridges present.

**% Cell Capacity (Assigned Cells/Total Cells)**

Display only.

Percentage of storage cells in the library allocated to this partition. Calculated as:

Number of cells allocated to the partition / Total physical capacity of the library

## Buttons

### Print

Click to print the report on a selected printer.

### Save

Click to save the report to a designated comma-separated text file (.csv extension). Comma-separated files can be opened by a variety of spreadsheet and database programs.

### Refresh

Click to refresh the SL Console partition workspace with current data from the library controller database. All uncommitted partition changes you have made during this SL Console login session will be discarded. The **Partition Refresh** popup appears, prompting you to confirm the refresh.

### ? (Help)

Click to display online help for the screen.

## See Also

- [Partitions—Reports—Cartridge Cell and Media Summary](#)
- [Partitions—Reports—Host Connections Summary](#)
- [Partitions—Reports—Orphaned Cartridge Report](#)
- [Partitions—Reports—Partition Summary](#)

# Partitions—Reports—Partition Summary

## Sample Screen

Tools Help **Partitions** ?

Instructions ( Step 1 ) Summary ( Step 2 ) Module Map ( Step 3a ) Design ( Step 3b ) Commit ( Step 4 ) **Reports** Current Partition Definitions

NOTE: The reports in this menu reflect only the current partition definitions stored on the library. Any changes to the partition definitions made in the Design tab will be reflected in the reports only after they are committed.

Partition Summary ▼

Partitions as of 7/23/09 1:30 PM

Partition ID	Partition Name	Connectic Type	Storage Cells	Media in Storage Cells	%Storage Cells w/ Media	Drives	CAP Cells	AEM Cells	Active Cells
1	one	SCSI	793	101	12.74%	16	52	0	793
2	Two	SCSI	903	55	6.09%	24	26	0	903

Print... Save To File...

SL3000 Comm Status UserID: root Library:crimson9.central.sun.com

## Description

Displays summary information for all partitions in the library.

---

**Note** – The partition reports display data saved to the library controller database. If you have made partition configuration changes without committing the changes to the library controller through the **Commit (Step 4)** screen, the data in these reports will differ from data shown on the partition **Summary (Step 2)** and **Design (Step 3b)** screens.

---

You can modify the layout and display of this screen. See [“Modifying the Screen Layout” on page 36](#) for details.

Optionally, you can print the screen data or save it to a comma-separated file.

## Screen Fields

---

**Note** – These screen fields also appear on the [Partitions—Reports—Host Connections Summary](#) report.

---

### **Partition ID**

Display only.  
ID of the partition (1–8).

### **Partition Name**

Display only.  
Name of the partition.

### **Connection Type**

Display only.  
Type of interface used by the host-partition connection. Options are:

- HLI
- FC-SCSI

### **Storage Cells**

Display only.  
Total number of storage cells allocated to the partition.

### **Media in Storage Cells**

Display only.  
Total number of tape cartridges resident in the partition's storage cells.

### **% Storage Cells w/ Media**

Display only.  
Percentage of storage cells containing tape cartridges. Calculated as **Media in Storage Cells / Storage Cells**.

### **Drive Bays**

Display only.  
Total number of drive bays allocated to the partition.

### **CAP Cells**

Display only.  
Total number of rotational CAP cells allocated to the partition.

### **AEM Cells**

Display only.  
Total number of AEM CAP cells allocated to the partition.

### **Active Cells**

Display only.  
Total storage cell capacity assigned to the partition in the **Add Partition** screen.



## Buttons

### Print

Click to print the report on a selected printer.

### Save

Click to save the report to a designated comma-separated text file (.csv extension). Comma-separated files can be opened by a variety of spreadsheet and database programs.

### Refresh

Click to refresh the SL Console partition workspace with current data from the library controller database. All uncommitted partition changes you have made during this SL Console login session will be discarded. The **Partition Refresh** popup appears, prompting you to confirm the refresh.

### ? (Help)

Click to display online help for the screen.

## See Also

- [Partitions—Reports—Cartridge Cell and Media Summary](#)
- [Partitions—Reports—Host Connections Summary](#)
- [Partitions—Reports—Orphaned Cartridge Report](#)
- [Partitions—Reports—Partition Details](#)

---

# Partition CAP Operation Screens

[Shared CAP Assignment](#)

[Diagnostics > CAP—Unreserve](#)

# Shared CAP Assignment

## Sample Screen

Tools Help **Shared CAP Assignment** Apply Refresh ?

**Partition and CAP Assignment Two Step Process:**

1. Select the partitions that you wish to have CAPs assigned to
2. Click 'Apply' to make the CAP assignment





Select	Partition Name	Partition ID	Connection Type	PEM	DEM	Base	PEM
<input type="checkbox"/>	1	1	scsi		X		
<input checked="" type="checkbox"/>	2	2	scsi		X	X	

**Shared CAP Assignment Rules:**

1. If the partition is grayed out but not selected, then either:
  - a. No CAPs have been assigned to the partition
  - b. Another partition who shares the same CAP has that CAP in use
  - c. CAP ownership by another partition has been assumed by default due to a cartridge being moved to the CAP
  - d. The corresponding partition is of type HLI
2. To successfully assign a partition to its CAP(s), the partition must be able to gain exclusive access to the CAPs that are assigned to it.
3. CAP Assignments do not persist across library changes for any of the following :
  - a. CAP Resets
  - b. Door Opens
  - c. Library Reboots
  - d. Partition Changes

◆ Note: If any of these activities have been performed and the assignment is not present, please reassign CAPs using this screen.

 SL3000
  Comm Status
UserID: root
 Library:crimson20.stortek.com

## Description

Allows you to perform partition-CAP associations prior to using a shared FC-SCSI CAP to enter or eject cartridges to or from a partition. Partition-CAP associations reserve a rotational or AEM CAP for the exclusive use of the selected partition for the duration of the enter or eject operation.

---

**Note** – This screen is not available if the library has no shared FC-SCSI CAPs.

---

---

**Note** – This screen is used for both rotational and AEM CAPs. Throughout this section, the term “CAP” refers to both types of CAPs.

---

The following rules apply when using this screen:

- You need to use this screen for shared FC-SCSI CAPs only.
- You do not need to use this screen for dedicated CAPs because a partition always has ownership of its dedicated CAPs.
- You do not need to use this screen for HLI partitions because HLI host applications always use CAP reservations.
- You can associate only one partition at a time to a CAP.
- Selecting a partition causes all its allocated CAPs to be associated to it at once; you cannot select individual CAPs to be associated to the partition.
- You can select multiple partitions at once, as long as the selected partitions do not share any CAPs with one another.
- Partition-CAP associations remain active until you explicitly remove them; the associations are not automatically removed when the enter or eject operation completes.
- Partition-CAP associations are removed during library reboots, power cycles, library door open/close operations, or CAP initializations
- Partition-CAP associations are removed if the CAP becomes allocated to a different partition through the **Design (Step 3b)** screen.
- If a partition-CAP association is removed while the CAP is open or has cartridges in it, the CAP ownership will be changed to the “default” requester and the CAP will be unavailable to all partitions. You must empty and close the CAP before it can be associated to any partitions.

See [“Enter Cartridges Into a Partition” on page 326](#) and [“Eject Cartridges From a Partition” on page 327](#) for complete details on using this screen in conjunction with the **CAP Open** button.

## Screen Fields

### Select

Select one or more partitions for which you want to enter or eject cartridges, as follows:

- Click the checkbox to select the partition; the screen is updated as follows:
  - All CAPs allocated to that partition are marked with the partition number on the module map.
  - All other partitions sharing CAPs with that partition are grayed out.
- Clear the checkbox to de-select the partition.

Partitions that are grayed out cannot be selected. A partition may be grayed out for any of the following reasons:

- No CAPs have been allocated to the partition.
- The partition has an HLI host-connection type.
- The CAP is currently in use by another partition that shares the CAP.
- The CAP is currently in use by the “default” user (library operator).

**Partition Name**

Display only.

Name assigned to the partition.

**Partition ID**

Display only.

ID assigned to the partition. IDs can range from 1–8.

**Connection Type**

Display only.

Type of interface assigned to the host-partition connection. Options are:

- HLI
- FC-SCSI

**Library module map**

Display only.

The screen displays an illustration of the library's actual module configuration. This information is taken directly from the library controller database.

The CAP allocations for each partition are indicated, as follows:

- An "X" in a library module column indicates the CAP in that module is allocated to the partition in that row.
- No "X" in a library module column indicates the CAP in that module is not allocated to the partition in that row.

**Buttons****Apply**

Click to update the library controller database with the current settings from this screen. The **CAP Confirm** popup appears, prompting you to confirm the update.

**Refresh**

Click to refresh the SL Console partition workspace with current data from the library controller database. All uncommitted partition changes you have made during this SL Console login session will be discarded. The **Partition Refresh** popup appears, prompting you to confirm the refresh.

**? (Help)**

Click to display online help for the screen.

**See Also**

- [Partitions—Design \(Step 3b\)](#)

## Diagnostics > CAP—Unreserve

### Sample Screen

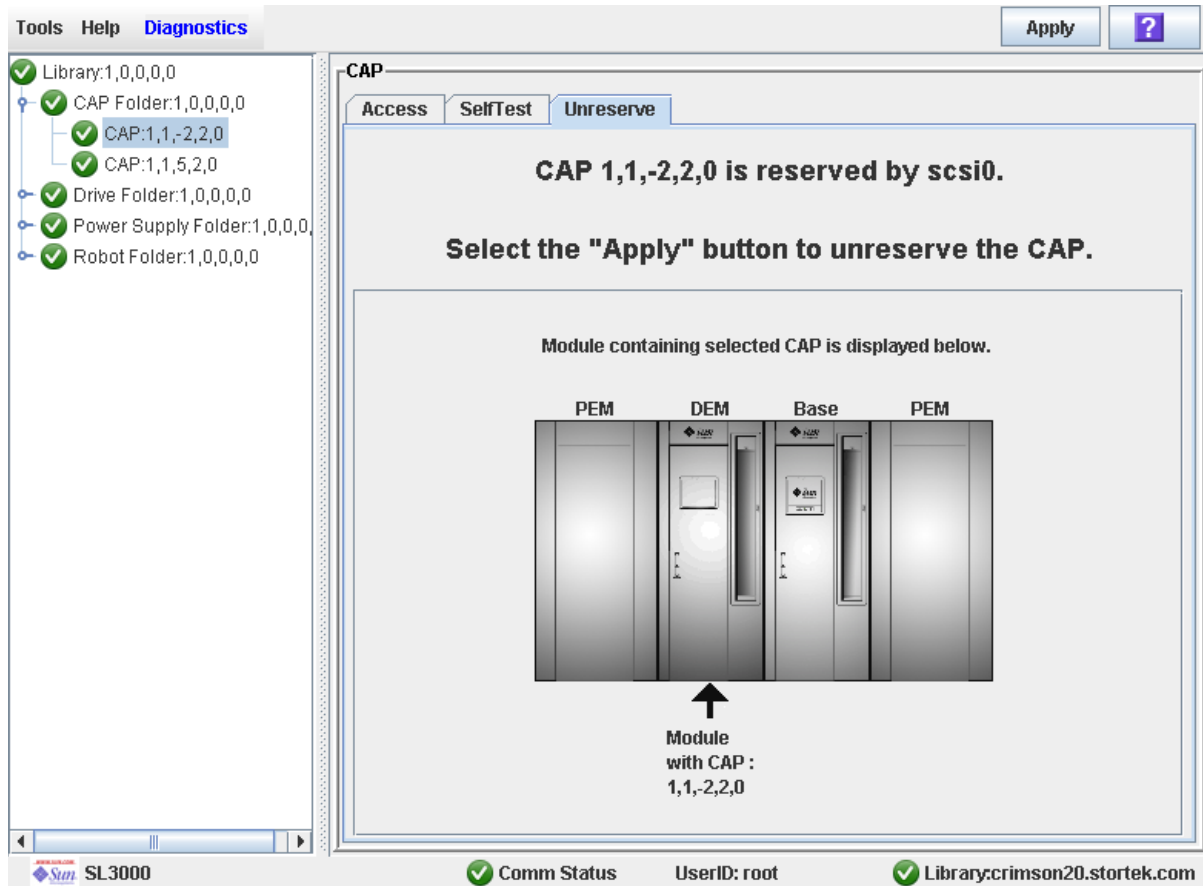

### Description

Allows you to override a CAP reservation that has been initiated by a host. This causes the library controller to remove the CAP reservation and set the CAP user to “default,” which makes the rotational or AEM CAP unavailable to all partitions.

After overriding the reservation you will need to open the CAP and remove any cartridges. After you close the CAP, the library controller will lock and audit the CAP to verify that it is empty. It will then set the CAP status to “unreserved,” which makes the CAP available to all partitions.

---

**Note** – For FC-SCSI CAPs, overriding a CAP reservation breaks any partition-CAP association, even if the CAP is dedicated to the FC-SCSI partition. You must explicitly associate the partition to the CAP again before the partition can use the CAP.

---

---

**Note** – This screen is used for both rotational and AEM CAPs. Throughout this section, the term “CAP” refers to both types of CAPs.

---

See [“Override a CAP Reservation” on page 329](#) for the detailed procedure.

## Screen Fields

**CAP CAP\_id is status.**

Display only.

Status of the selected CAP. Possible options are:

- `reserved by host_name` – A CAP operation has been initiated by the specified host; you can use this screen to unreserve the CAP.
- `reserved by default` – A CAP operation has been initiated at the SL Console; you cannot use this screen to unreserve the CAP.
- `not reserved` – The CAP is not reserved; you do not need to unreserve the CAP.

**Module containing selected CAP is displayed below**

Display only.

The screen displays an illustration of the library’s actual module configuration. This information is taken directly from the library controller database.

The CAP you have selected is marked by an arrow.

## Buttons

### Apply

Click to override the host CAP reservation. The **CAP Confirm** popup appears, prompting you to confirm the update.

---

**Note** – This button is active only if the CAP status is “`reserved by host_name`”.

---

### ? (Help)

Click to display online help for the screen.

## See Also

- [Shared CAP Assignment](#)





## SL Console Diagnostics and Utilities

---

---

### Library Events

The library controller continually monitors library operations and logs all events. Events are stored under three headings:

- Communication events – Includes host-to-library, library-to-library, and library-to-drive communications.
- Error event – Each error event is assigned a four-digit (hexadecimal) action code.
- Warning events – Indicate a loss of performance or conditions that may be indicative of future, fatal errors.

### Event Monitors

You or your Sun support representative can use the SL Console monitors to review library events. You can spool the event monitor information to a text file.

The following information can help to diagnose the cause of the event:

- Date/time stamp – Identifies when the event occurred.
- Action codes – Identifies the command that was issued, such as “load drive”.
- Result codes – Identifies the result of the requested action. See [“List a Result Code” on page 423](#) to look up a result code.
- Known service plan (KSP) diagnosis – Identifies the mechanism or component responsible for the task or fault.

---

**Note** – There is no option to clear the event log.

---

## Library Self-Tests

The self-test diagnostic utility is intended to help diagnose basic problems with the library. A self-test is typically run after the library is installed. It can be run whenever necessary.

---

**Note** – The library self-test routines are non-disruptive.

---

Library self-tests involve the following process:

1. Checks the communication path between the library controller, drives, and TallBots.
2. Performs get and put operations to check the health of the TallBots and rotational or AEM CAPs. This includes get and put operations from a reserved cell to a random empty:
  - Storage cell
  - CAP cell
3. Performs a full library audit.
4. Performs mounts and dismounts of diagnostic cartridges for all the drives installed in the library.

---

**Note** – The self-test will not start unless a diagnostic cartridge is found in the reserved cells.

---

---

**Note** – The self-test is repeated for each drive type if a compatible diagnostic cartridge is found in the reserved cells. If a diagnostic cartridge is not found for a drive type, the mount/dismount operation is skipped for the drive.

---

---

# Library Firmware Upgrades

The library firmware resides on the library controller. The initial firmware is installed at the factory. When new firmware is released, you must use the code load utility to upgrade the firmware on the library and associated devices (rotational or AEM CAP and TallBot).

---

**Note** – Library firmware does not contain drive code upgrades.

---

## Firmware Download Site

The SL3000 library firmware package is a .jar (Java Archive) file. The file is available at the following download site:

<http://www.sun.com/download/index.jsp>

---

**Note** – You must have a valid login ID and password for the download site you are using. Contact your Sun support representative for assistance.

---

## Firmware Installation Process

The process for loading firmware code on the library controller is as follows:

1. Locate the firmware upgrade package (.jar file) on the Sun download site. See [“Firmware Download Site” on page 407](#).
2. Download the code to a folder on your local PC or workstation.
3. Download the firmware package from your PC to the library controller. This process also unpacks the package after downloading to make it ready for activation. See [“Download Code to the Library Controller” on page 428](#).
4. Activate the downloaded code on the library controller. See [“Activate Code on the Library Controller” on page 430](#).
5. Reboot the library to make the code operational. See [“Reboot the Library” on page 426](#).

---

## Audits

An audit is the process of reading and cataloging cartridges within a library, verifying the locations of cartridges, or validating a range of slot locations. The library controller maintains a cartridge database that contains the following information for all the cartridges in the library:

- Volume ID (VOLID or volser)
- Current location (in library internal address format)
- Verified status (true or false)

The library audits all cartridge locations in the storage and reserved areas at the following times:

- After one or both access doors have been opened and closed.
- An audit request is made through the SL Console.
- A host request to audit the library is entered.

You can use the SL Console to perform the following types of audits:

- [Physical Audit](#)
- [Verified Audit](#)

---

**Caution** – System-level problems may occur if a host’s cartridge record does not match what is in the library controller cartridge database.

---

## Physical Audit

In a physical audit, the TallBot visits cartridge locations and verifies the VOLID of resident cartridges, and the library controller updates the cartridge database. This audit changes the “verified” status of the cartridge locations to “True.” Audit times vary according to the size of the library. Audits take approximately 1/2 second per cartridge slot, per TallBot.

The library performs a physical audit at the following times.

- At library power-up, or when a library access door has been opened and closed. This is always a full audit of the entire library.
- In libraries with an AEM, whenever the AEM access door is closed. This is a full audit of the AEM.
- When initiated manually from the SL Console. There are two types of manually initiated physical audits:
  - Entire library audit – The TallBot visits all cells (storage, rotational and AEM CAP, and drive), catalogs the VOLIDs and locations, and updates the library controller cartridge database. This audit is a background process and so does not interrupt online library operations. See [“Audit the Entire Library” on page 438](#) for details.

- Specific range audit – The TallBot visits only a specific range of cells (storage, rotational or AEM CAP, and drive) and updates the library controller cartridge database. The audit information is displayed on the SL Console while the audit is performed. See [“Audit a Range of Cells” on page 440](#) for details.

## Verified Audit

A verified audit validates the status of a specific cartridge location or range of locations (including rotational and AEM CAPs and drives) in the cartridge database. If a cartridge address has a verified status of “false” then a physical audit of that location is performed and the cartridge database is updated. The progress of the audit is displayed in the Audit Console section of the SL Console. See [“Perform a Verified Audit” on page 442](#) for details.

---

# Robot Diagnostic Moves

Diagnostic moves are used to monitor or diagnose a problem with a TallBot. The move can be performed with or without cartridges.

Successful diagnostic moves do not rearrange the cartridges in the storage cells; cartridges are returned to their original locations after the diagnostic move is completed. However, some diagnostic move failures can cause cartridges to be left in new locations.

A diagnostic move involves the following elements:

- [Target Address Range](#)
- [Pool Address Range](#)
- [Move Access Order](#)
- [Robot Selection](#)

## Target Address Range

The target address range defines the location parameters in a library within which the get operation is performed in a diagnostic move. There are two types of access orders for a target address:

- [“Sequential Access Order” on page 411](#)
- [“Random Access Order” on page 411](#)

Following are valid target address types:

- Storage cells – Reserves storage locations as the target/pool range
- CAP – Reserves cells in a rotational or AEM CAP as the target/pool range.
- Drive and Storage cells – Reserves drives and storage cells as the target/pool range.
- Reserved cells – Reserves reserved (system) cells, which contain cleaning or diagnostic cartridges, as the target/pool range.
- All – Reserves storage cells, reserved cells, rotational or AEM CAP cells and drives as the target/pool range.

---

**Note** – Selecting the Storage, CAP, drive, system, or All option does reserve all the associated locations as the target range. However, only the location currently being accessed by the TallBot for a get/put operation is unavailable to the host.

---

## Pool Address Range

The pool address range locations are used to supply cartridges required for diagnostic moves to and from the target address range. A pool address is also used in a get operation if a target address does not contain a cartridge. There is no specified access order within the pool address range. The pool address ranges does not include drive locations.

---

**Note** – The pool address ranges cannot contain drive locations.

---

## Move Access Order

### Sequential Access Order

In a sequential access order diagnostic move, the TallBot performs a get operation starting with the first location in the target address ranges and then continues visiting the locations sequentially through the range until it completes the requested number of moves.

---

**Note** – If you choose not to move cartridges the get/put operations are not performed. The TallBot just positions itself at the target and pool addresses.

---

### Random Access Order

In a random access order diagnostic move, the TallBot randomly picks a location in the target address range to get a cartridge. The TallBot can also visit the same location in the in the target address range multiple times to get a cartridge. The random access routine ends after the requested number of moves is complete.

If you choose not to move cartridges the get/put operations are not performed. The TallBot just positions itself at the target and pool addresses.

## Robot Selection

The TallBot for the diagnostic move is selected based on the minimum and maximum ranges you set for the target and pool addresses. Multiple robots maybe selected if the address range requires it.

## Diagnostic Move Control Functions

The following options are available to manage the moves currently open:

To	Select Menu Option	Notes
Start	File > Start Sequence	
Pause	File > Pause Sequence	Stops all diagnostic moves, but maintains the current location in the access order.
Stop	File > Stop Sequence	Stops a running or paused exerciser.

To	Select Menu Option	Notes
Resume	File > Start Sequence	Resumes a paused exerciser starting with the last known location in the target address range.
Clear the messages displayed in the monitor window	File > Clear Output Window	Erases the previous message lines and continues to fill the screen with new messages.
Spool	Spool File > Start Spooling	Directs the move output to a file.
Stop spooling the exerciser output to a file	Spool File > Stop Spooling	Stops directing the move output to the spool file.

---

**Note** – If multiple diagnostic moves are open, then each move has its own monitor screen.

---



# Troubleshooting

Before you run diagnostic tests, check the following areas of the library using the troubleshooting tips in the following table:

TABLE 7-1 Troubleshooting Table

Problem	What to do
Service Required (amber) LED is constantly on.	<p><b>Perform the following procedure:</b></p> <p>Using the SL Console, check the health of the library and the attached devices (drives, rotational and AEM CAPs, and TallBots). See <a href="#">“StorageTek Library Console” on page 33</a> for more details about operations.</p> <p>To perform a health check:</p> <ol style="list-style-type: none"> <li>1. Log in to the SL Console application.</li> <li>2. Access the System Detail module, View &gt; System Detail.</li> <li>3. Check the device tree for the following indicators: <ul style="list-style-type: none"> <li>■ Device Healthy</li> <li>■ Device Error</li> </ul> </li> </ol> <p>The Status (for example, online/offline) and Statistics (for example, uptime, downtime, errors and warnings) tabs provide more information on the health of the library and devices.</p> <p>Other checks:</p> <ul style="list-style-type: none"> <li>■ Make sure that cartridges are fully seated and properly oriented in their storage cells.</li> <li>■ Inspect the X table for any foreign objects or debris; remove them if found.</li> </ul>
CAP Open LED is on and blinking.	Open the rotational or AEM CAP and make sure that the cartridges in the CAP cells are properly seated.
The SL Console does not display modified data or information remains static.	Check the SL Console Heartbeat icon.
Robot Fault or Library Fault Amber LED is constantly on.	<ol style="list-style-type: none"> <li>1. Check the SL Console for any displayed error messages. Write down the error messages reported.</li> <li>2. Open the front door. Observe and note the state of the cartridges, hand, and tape drives.</li> <li>3. Make sure that cartridges are fully seated and properly oriented in their storage cells.</li> <li>4. Make sure that packing materials have been removed.</li> <li>5. Inspect the library floor for any objects or debris; remove them.</li> <li>6. Check the status of the tape drives.</li> <li>7. Close the front door.</li> <li>8. Make sure that the tape drives are fully seated and locked forward by pushing and pulling on the rear of the drive tray. Any motion of the tray indicates that it requires reseating and locking down.</li> </ol>
Tape drive is unable to eject a cartridge.	Manually remove the cartridge from the tape drive. <a href="#">“Remove a Cartridge from a Tape Drive” on page 325</a> .

TABLE 7-1 Troubleshooting Table (Continued)

<b>Problem</b>	<b>What to do</b>
The client computer cannot communicate with the library or tape drives.	<ol style="list-style-type: none"> <li>1. Make sure that cables are securely attached to their connectors on the rear of the library, the tape drives, and the client computer.</li> <li>2. Make sure that each SCSI device on the same bus has a unique address and that the last device is properly terminated.</li> </ol>
The library is unable to communicate with the drives. Drive status on the SL Console displays Not communicating.	<ol style="list-style-type: none"> <li>1. Make sure that cables are securely attached to their connectors on the rear of the library, the drives, and the client computer.</li> <li>2. Make sure that each SCSI device on a bus has a unique address and that the last device is properly terminated.</li> </ol>
Repeated or excessive drive cleanings or cleaning messages.	<ol style="list-style-type: none"> <li>1. Replace the cleaning cartridge with a new cleaning cartridge.</li> <li>2. Run the Library Self-Test and note if errors are reported for the drive.</li> <li>3. Run any client computer-based drive diagnostic tests.</li> </ol>

---

# Diagnostic Support Files

The following diagnostic support files are maintained on the library in order to aid in troubleshooting and diagnosing problems:

- [MIB File](#)
- [Library Log Snapshot File](#)

Depending on circumstances, your Sun support representative may request you to transfer one or both of these files to Sun for further evaluation, or he or she may do this him or herself.

## MIB File

The management information base (MIB) file is a small network management protocol (SNMP) database used to manage your library devices. This file can be saved as a text file. See [“Transfer the Library MIB File” on page 432](#) for detailed instructions.

## Library Log Snapshot File

---

**Note** – This feature is available starting with SL3000 firmware version FRS\_2.30 and SL Console version FRS\_4.30.

---

Your Sun support representative can use privileged CLI commands to generate an encrypted snapshot of the library event log. You cannot view or edit this file. This file is available for only 15 minutes from the time it is generated. See [“Transfer the Library Log Snapshot File” on page 434](#) for detailed instructions.

## Diagnostic and Utility Tasks

Library diagnostic and utility tasks are divided into the following categories:

- [“Event Monitor Tasks” on page 417](#)
- [“Library Utility Tasks” on page 424](#)
- [“Audit Tasks” on page 437](#)
- [“Rotational and AEM CAP Utility Tasks” on page 444](#)
- [“Drive Utility Tasks” on page 450](#)
- [“TallBot Utility Tasks” on page 454](#)
- [“AEM Safety Door Utility Tasks” on page 471](#)

---

# Event Monitor Tasks

<b>Task</b>	<b>Page</b>
<a href="#">Display an Event Monitor</a>	418
<a href="#">Spool Event Monitor Data to a File</a>	419
<a href="#">Display Multiple Monitors</a>	420
<a href="#">List a Device Status Code</a>	421
<a href="#">List a Result Code</a>	423

## ▼ Display an Event Monitor

Event monitor information is dynamically updated depending upon occurrence of the selected events. The information sent during an e-mail, print, save, or spool operation reflects the data (and format) shown on-screen at the time the operation is requested.

---

**Note** – Event monitors are useful tools for root cause analysis of errors. If the library is experiencing reproducible errors, you can open an event monitor and spool all events to a file to capture the data. Later, you can send the file to your Sun support representative for analysis.

---



---

**Note** – To monitor multiple events, see [“Display Multiple Monitors” on page 420](#).

---

1. **Select Tools > Monitors.**
2. **Expand the Permanent Monitors folder.**  
The library monitors you have access to are displayed.
3. **Click the event monitor you want to use, and then click Open from the Options Bar.**  
The system displays the associated data collected for the event.
4. **Use these options to manage the information displayed on the screen for the event selected:**

Select	To
Monitor > Pause	Pause the continuous display of data related to the event selected
Monitor > Resume	Resume displaying the events
Monitor > Stop	Permanently stop the continuous display of data related to the event selected
Monitor > Clear	Clear the event monitor display

5. **To close a monitor, click the X in the upper right corner of the window.**

## ▼ Spool Event Monitor Data to a File

Use this procedure to spool and save event monitor data to a file. You can send the file to your Sun support representative to assist in diagnosing problems.

**1. Select Tools > Monitors.**

**2. Expand the Permanent Monitors folder.**

The library monitors you have access to are displayed.

**3. Click the event monitor you want to use, and then click Open from the Options Bar.**

The system displays the an event monitor window.

**4. In the event monitor window, select Spool File > Start Spooling.**

The **Save** popup appears.

**5. Browse to the directory where you want to save the file. In the File Name field, enter the file name, and click Save.**

All event data is spooled to the specified file.

**6. To stop spooling, select Monitor > Stop Spooling.**

Following is a sample of the spool file:

```
2008-05-29T11:23:27.448 0,1,0,0    root default      internal      281    warn
0 rb_Reboot::reboot(): Resetting drive [0,3,4,9]
2008-05-29T11:23:27.760 0,1,0,0    root default      internal      281    info
0 Service Beacon is ACTIVE: Current Health Event indicates Drive 04 in Module 03 is
not operational
2008-05-29T11:23:53.211 0,1,0,0    root default      internal      281    info
0 Service Beacon is ACTIVE: Current Health Event indicates Drive 04 in Module 03 is
operational
```

## ▼ Display Multiple Monitors

You can open and manage multiple event monitors using these selections from the Options Bar:

<b>To</b>	<b>Select</b>
Custom arrange the open monitors on screen	Window > Arrange
Arrange the event monitor windows horizontally	Window > Tile Horizontal
Arrange the event monitor windows vertically	Window > Tile Vertical
Stack the event monitors	Window > Cascade



## ▼ List a Device Status Code

Use this procedure to list device status codes and their descriptions.

1. Select **Tools > Diagnostics**.
2. Click the **Library** folder on the device tree.

The **Library** screen appears.

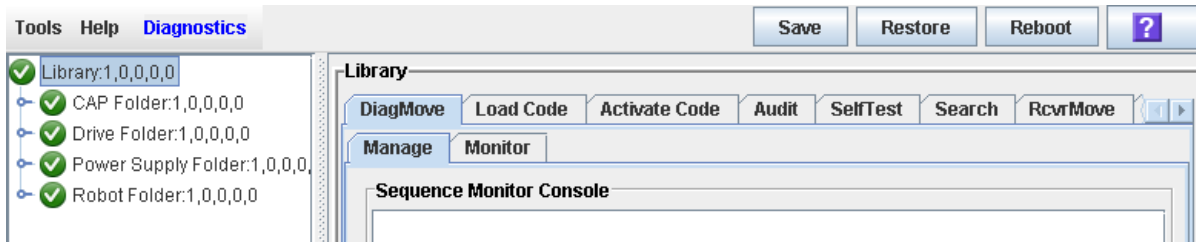

3. Click the **Search** tab.

The **Library Search** screen appears.

4. In the **Search Type** pull-down, click **Device Status**.
5. Complete the **Device Status** field, as follows:
  - To search for a specific device status code, enter the complete code; wildcards or partial codes are not accepted.
  - To list all device status codes, click the **List All** checkbox.

6. Click Search in the Options Bar.

The screen lists the specified device status codes and their descriptions.

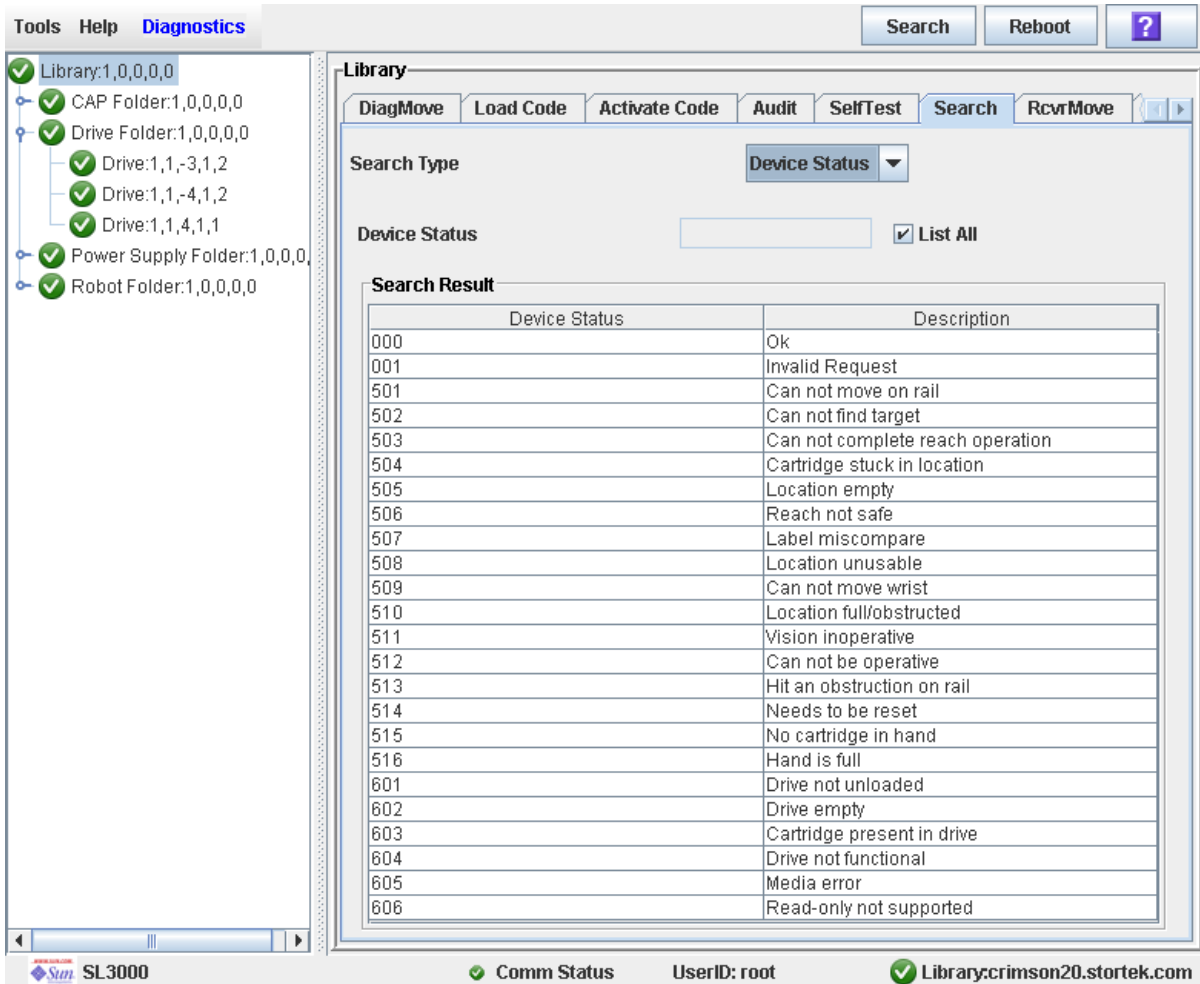

## ▼ List a Result Code

Use this procedure to list result codes and their descriptions.

1. Select **Tools > Diagnostics**.
2. Click the **Library** folder on the device tree.

The **Library** screen appears.

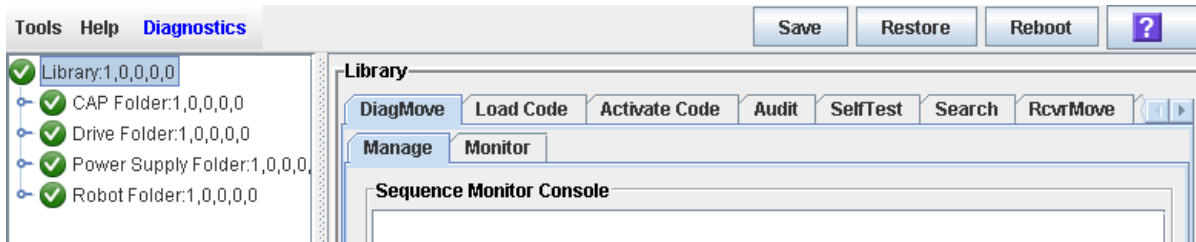

3. Click the **Search** tab.

The **Library Search** screen appears.

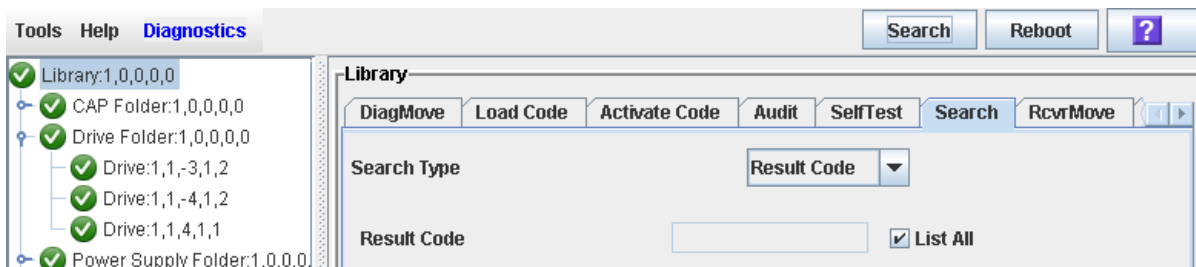

4. In the **Search Type** pull-down, click **Result Code**.
5. Complete the **Result Code** field, as follows:
  - To search for a code, enter the complete code; wildcards or partial codes are not accepted.
  - To list all codes, click the **List All** checkbox.

---

# Library Utility Tasks

<b>Task</b>	<b>Page</b>
<a href="#">Perform a Library Self-Test</a>	425
<a href="#">Reboot the Library</a>	426
<a href="#">Download Code to the Library Controller</a>	428
<a href="#">Activate Code on the Library Controller</a>	430
<a href="#">Transfer the Library MIB File</a>	432
<a href="#">Transfer the Library Log Snapshot File</a>	434

## ▼ Perform a Library Self-Test

---

**Note** – The proper diagnostic cartridges for library drives must be present in the library.

---

1. Select **Tools > Diagnostics**.
2. Click the **Library** folder on the device tree.

The **Library** screen appears.

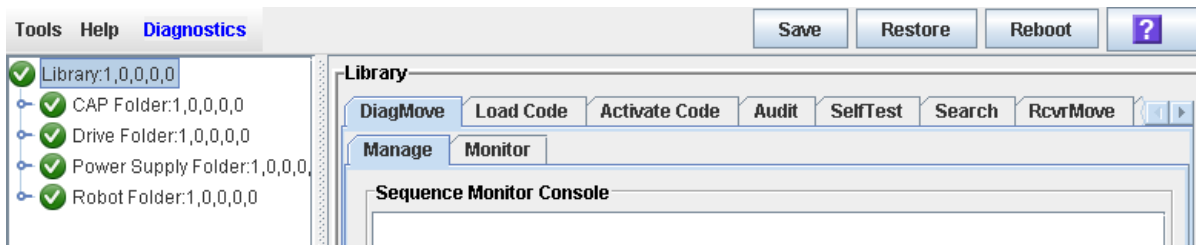

3. Click the **SelfTest** tab.

---

**Note** – The self-test screen displays a Mode field with two options: disruptive and non-disruptive. At present, only the non-disruptive option is valid.

---

4. Click the **Run** tab from the Options Bar.

During the self-test the SL Console window displays the status of the various diagnostics being performed.

## ▼ Reboot the Library

Use this procedure to reboot the library. This process involves reloading the firmware from flash memory and restarting the library controller.

1. Select **Tools > Diagnostics**.
2. Click the **Library** folder on the device tree.

The **Library** screen appears.

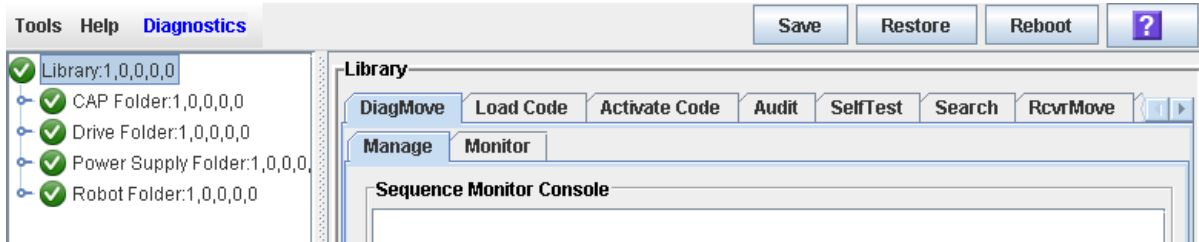

3. Click **Reboot** in the Options Bar.

The **Reboot** confirmation popup appears.

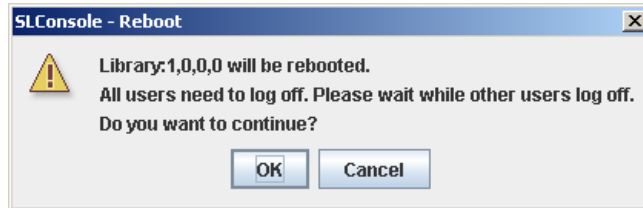

4. Click **OK** to continue.

If the library is online, the **Offline** confirmation popup appears.

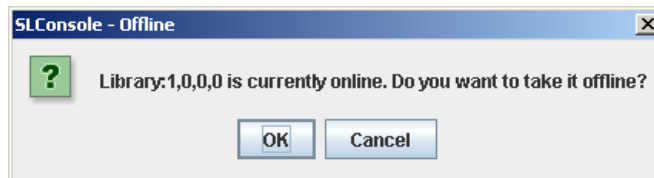

5. Click **OK** to vary the library offline.

The **Reboot** confirmation popup appears

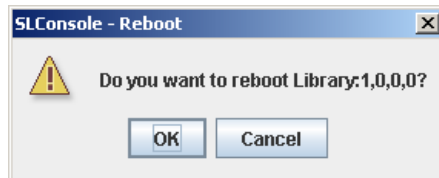

6. Click **OK** to continue.

The SL Console termination popup appears.

7. Click **OK** to terminate this SL Console session.

You are logged off the SL Console.

The library controller reboots the library. This may take several minutes.

---

**Note** – You will not be able to log back in to the SL Console until the library has fully initialized.

---

## ▼ Download Code to the Library Controller

Use this procedure to download updates to the library controller firmware.

---

**Note** – This procedure is not used for downloading drive firmware updates.

---

**Note** – You can perform this procedure from the standalone SL Console or Web-launched SL Console only. It is not available at the local operator panel.

---

1. Select **Tools > Diagnostics**.
2. Click the **Library** folder on the device tree.

The **Library** screen appears.

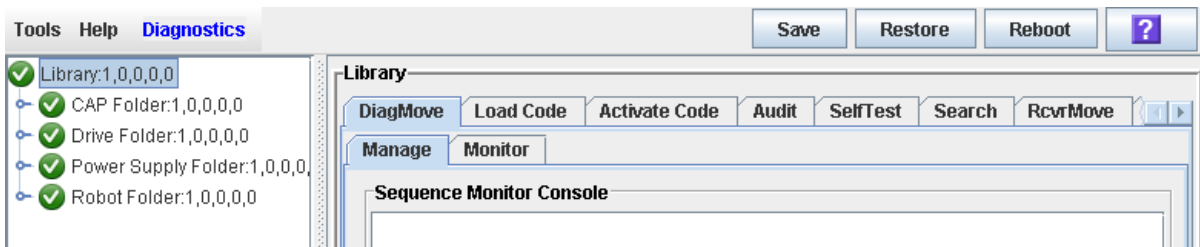

3. Click the **Load Code** tab.

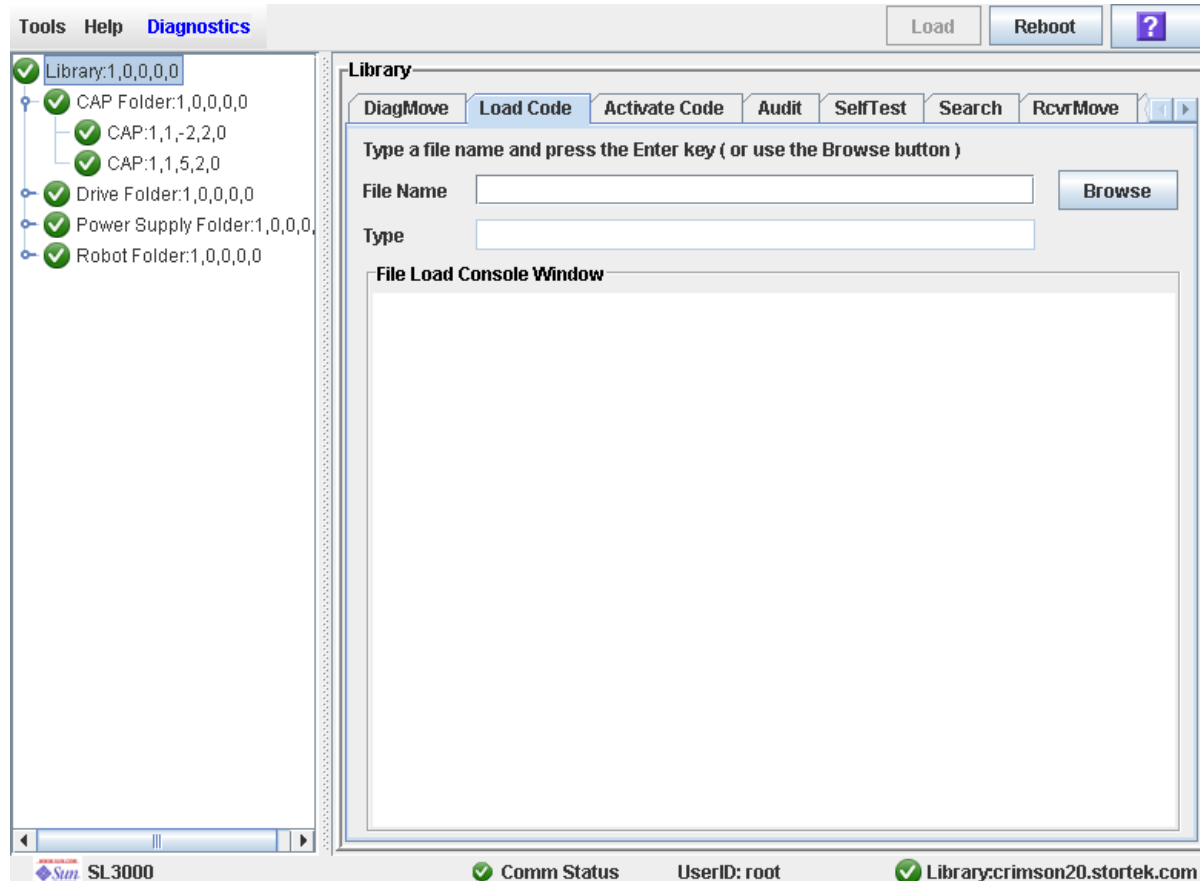



4. Click the **Browse** button to locate, select the folder and file name containing the firmware package (.jar file) on your PC, and then click **Open**.
5. Click the **Load** button from the **Options Bar**.
6. Click **OK** to confirm the download.

---

**Note** – The download process could take up to five minutes. The SL Console indicates the progress of the file transfer from the PC to the library controller.

---

---

**Note** – After the downloading, the system unpacks the package.

---

7. After the package is successfully unpacked, you can activate the code immediately, or you can wait until a later time. See [“Activate Code on the Library Controller”](#) on page 430 for detailed instructions.

## ▼ Activate Code on the Library Controller

Activating the code makes the code residing in the library controller ready for operation.

1. Select Tools > Diagnostics,
2. Click the Library folder on the device tree.

The Library screen appears.

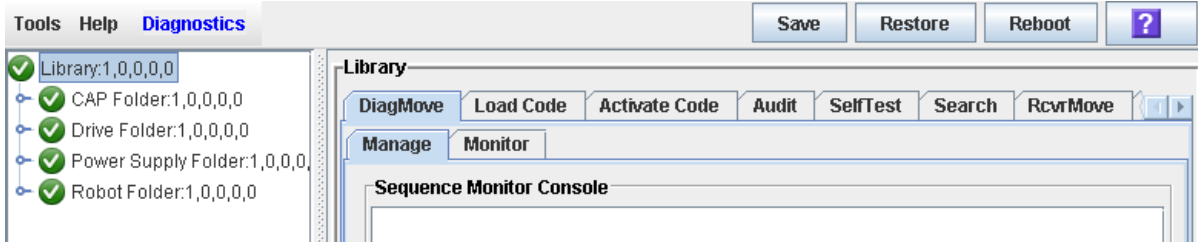

3. Click the Activate Code tab.

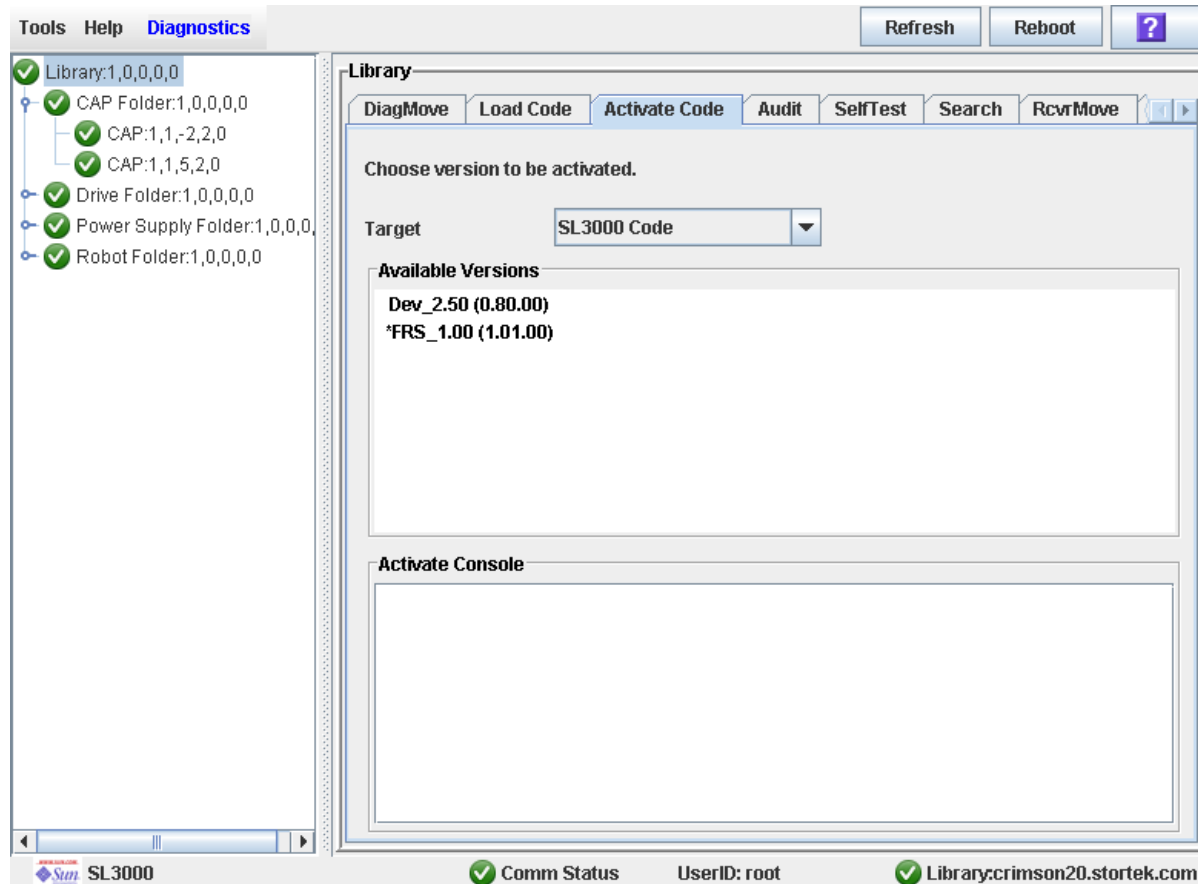

4. Click the Target on the pull-down menu.

---

**Note** – Target refers to firmware package (.jar file) containing the SL3000 library code.

---

5. Click the code to activate from the Available Versions section.

---

**Note** – The version prefixed with an "\*" is the code currently active. You can not select this code again to activate.

---

6. Click the Activate button in the Options Bar.

---

**Note** – The activate code process could take up to ten minutes to complete.

---

---

**Caution** – POTENTIAL INTERNAL FILE CORRUPTION. Do not reboot any devices in the library or execute any operations on the library while code is being activated.

---

7. Click OK to continue.

---

**Note** – The Activate Console screen displays the status of the code activation process. The code you just activated is listed in the available versions section, marked with an "\*". The unpacked version and previously activated versions of the code are also listed (without the "\*").

---

8. The system prompts you to reboot the library. Click OK to reboot the library.

---

**Note** – The library has two versions of the image file residing in the flash memory. After the library completes the reboot process, the latest image becomes active and the earlier version serves as a backup. The earlier version may be restored if required.

---

9. Click OK to terminate the SL Console session.

10. In the logon screen, click Exit to close the application.

Wait for the library to complete the initialization before you log in to the SL Console again.

The SL Console gets all library configuration data from the library controller. Therefore, you should be careful when logging in to the SL Console before the library has fully initialized. You may see warnings that configuration data is not yet available, in which case you need to exit and log in again at a later time. Additionally, if a library audit is performed as part of initialization, until the audit is complete, any configuration data displayed may not be completely up-to-date and accurate.

## ▼ Transfer the Library MIB File

Use this procedure to copy the public SNMP management information base (MIB) file to a specified location on your local PC or workstation. The file is saved as a text file. You can e-mail the file to your Sun support representative to help diagnose problems with the library.

1. Select **Tools > Diagnostics**,
2. Click the **Library** folder on the device tree.

The **Library** screen appears.

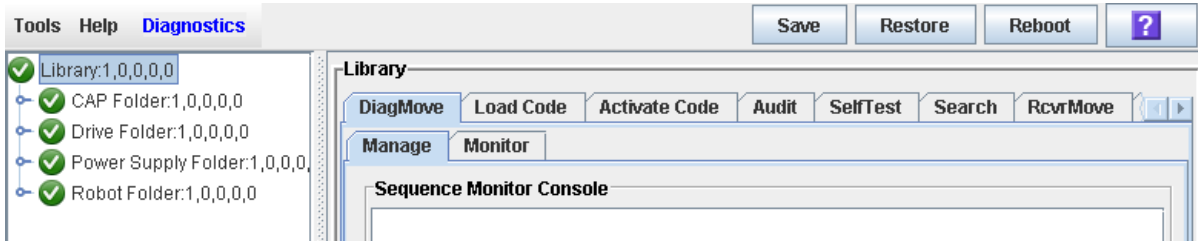

3. Click the **TransferFile** tab.

The file transfer screen appears.

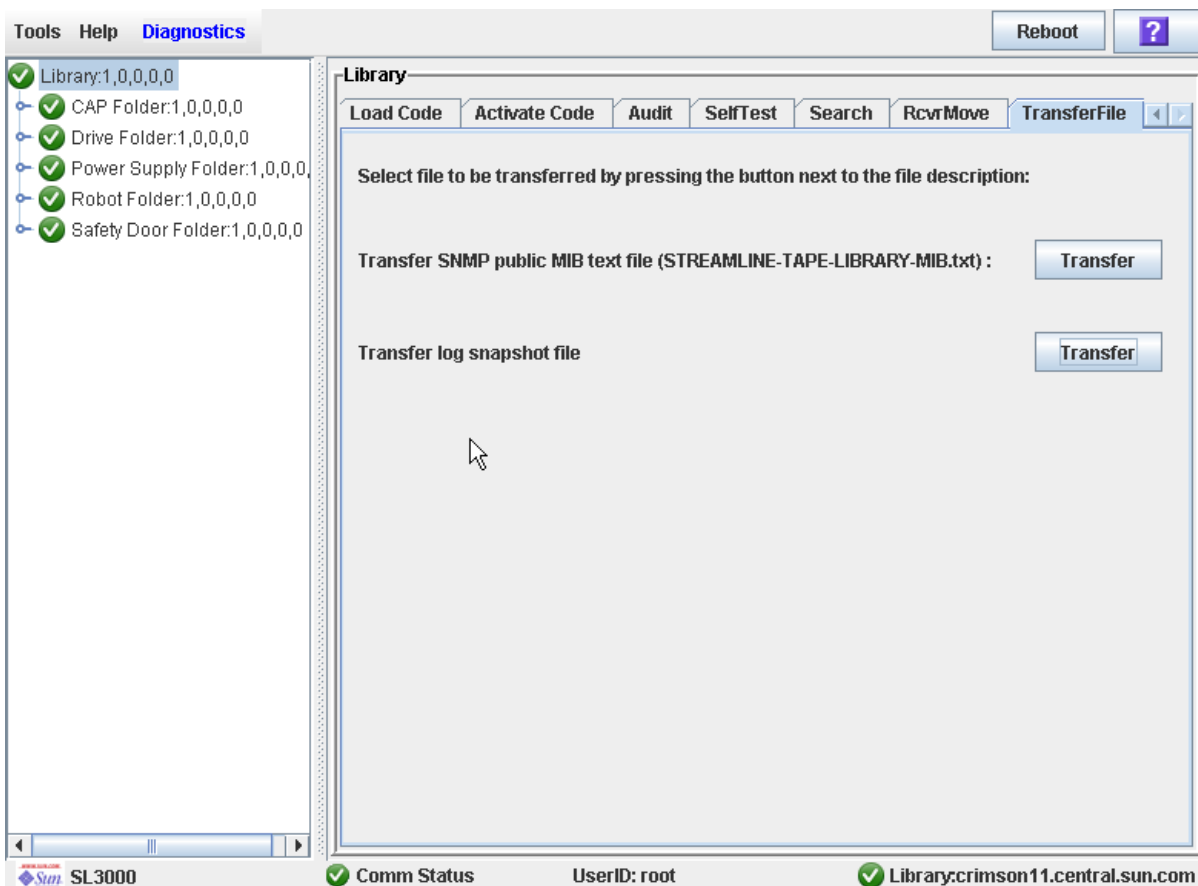

4. In the Transfer SNMP public MIB text file field, click the Transfer button.

The Save popup appears.

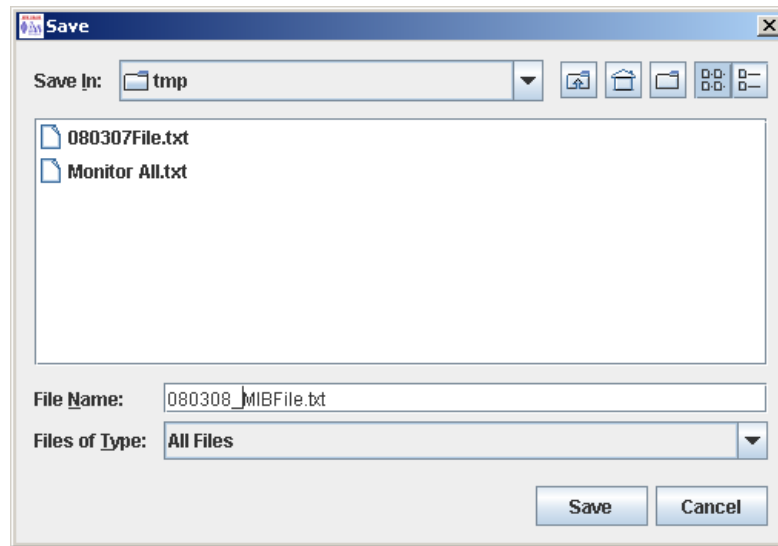

5. Browse to the directory where you want to save the file, and enter the file name in the File Name field. Be sure to give it a .txt suffix.
6. Click Save.

The data is saved to the specified file, and the **Transferred Successful** popup appears.

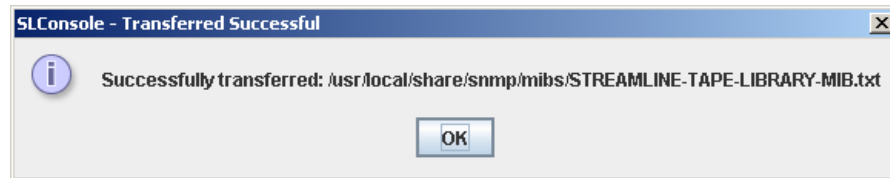

7. Click OK to dismiss the popup.

## ▼ Transfer the Library Log Snapshot File

---

**Note** – Use this procedure only under the direction of your Sun support representative. Your Sun support representative must have generated a library log snapshot file within the previous 15 minutes.

---

Use this procedure to copy the library log snapshot file to a specified location on your local PC or workstation. The file is saved in an encrypted format, and you cannot view or edit it. You can e-mail the file to your Sun support representative to help diagnose problems with the library.

1. Select **Tools > Diagnostics**,
2. Click the **Library** folder on the device tree.

The **Library** screen appears.

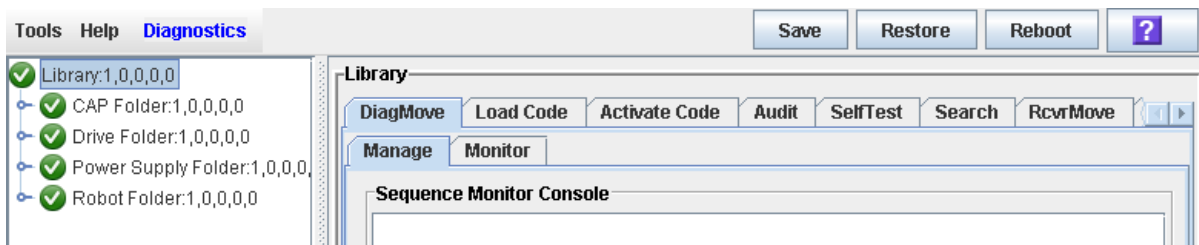

3. Click the TransferFile tab.

The file transfer screen appears.

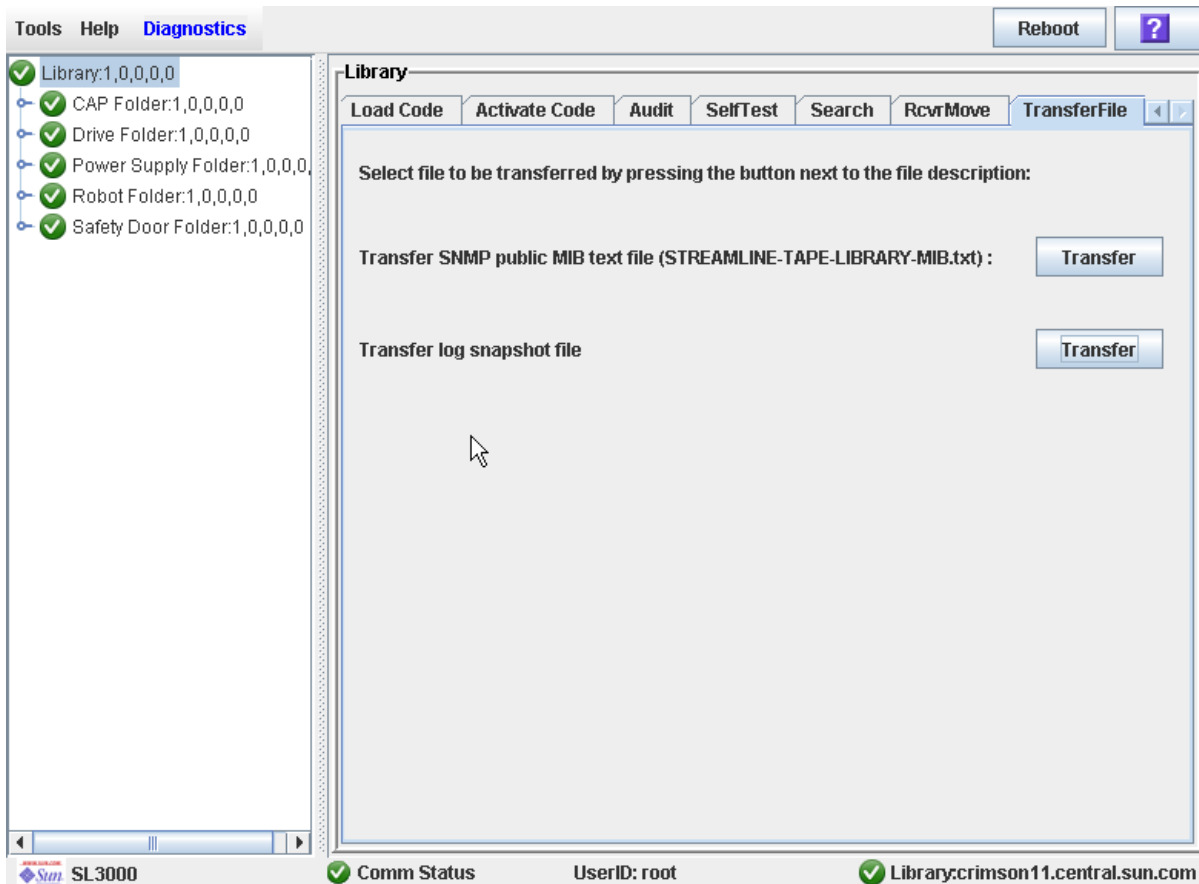

4. In the Transfer log snapshot file field, click the Transfer button.

The Save popup appears.

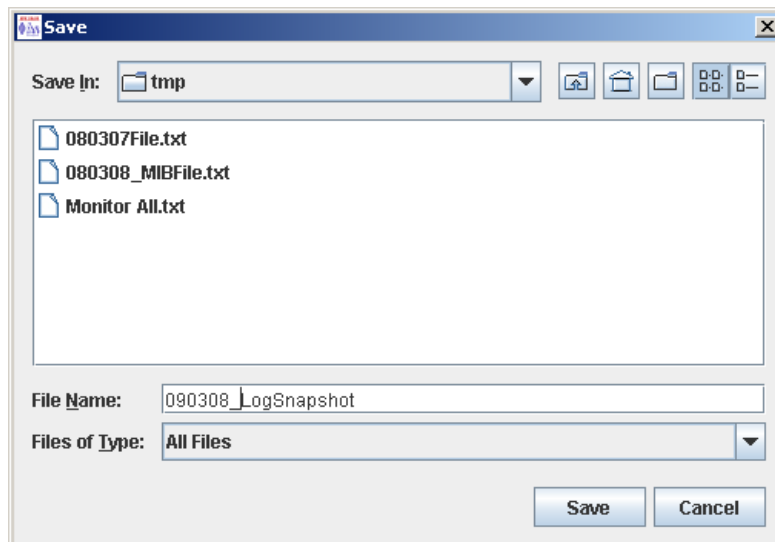

5. Browse to the directory where you want to save the file, and enter the file name in the File Name field.
6. Click Save.

The data is saved to the specified file, and the **Transferred Successful** popup appears.

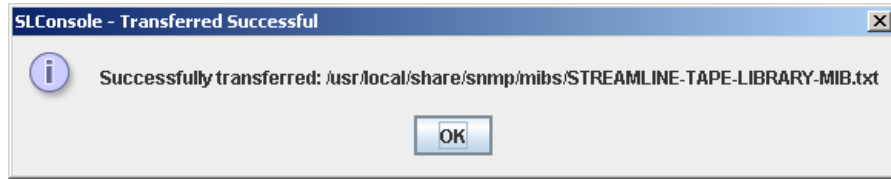

7. Click OK to dismiss the popup.



---

# Audit Tasks

<b>Task</b>	<b>Page</b>
<a href="#">Audit the Entire Library</a>	438
<a href="#">Audit a Range of Cells</a>	440
<a href="#">Perform a Verified Audit</a>	442

## ▼ Audit the Entire Library

During this audit the TallBot visits all the storage cells, catalogs the VOLIDs and locations, and updates the library controller database.

---

**Note** – Although this audit is a background process and does not interrupt library operations, it does require sharing of TallBot resources. Therefore, it is not recommended that you run this audit during peak activity periods.

---

---

**Note** – You cannot stop this audit once it has initiated. The audit will take approximately 1/2 second per cartridge slot.

---

1. Select **Tools > Diagnostics**.
2. Click the **Library** folder on the device tree.

The **Library** screen appears.

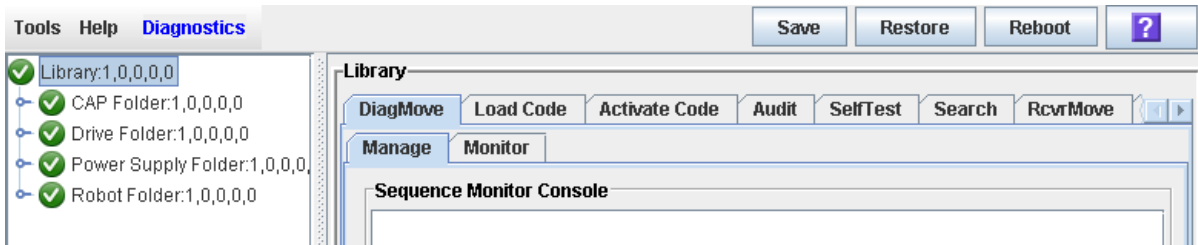

3. Click the Audit tab.

The Library Audit screen appears.

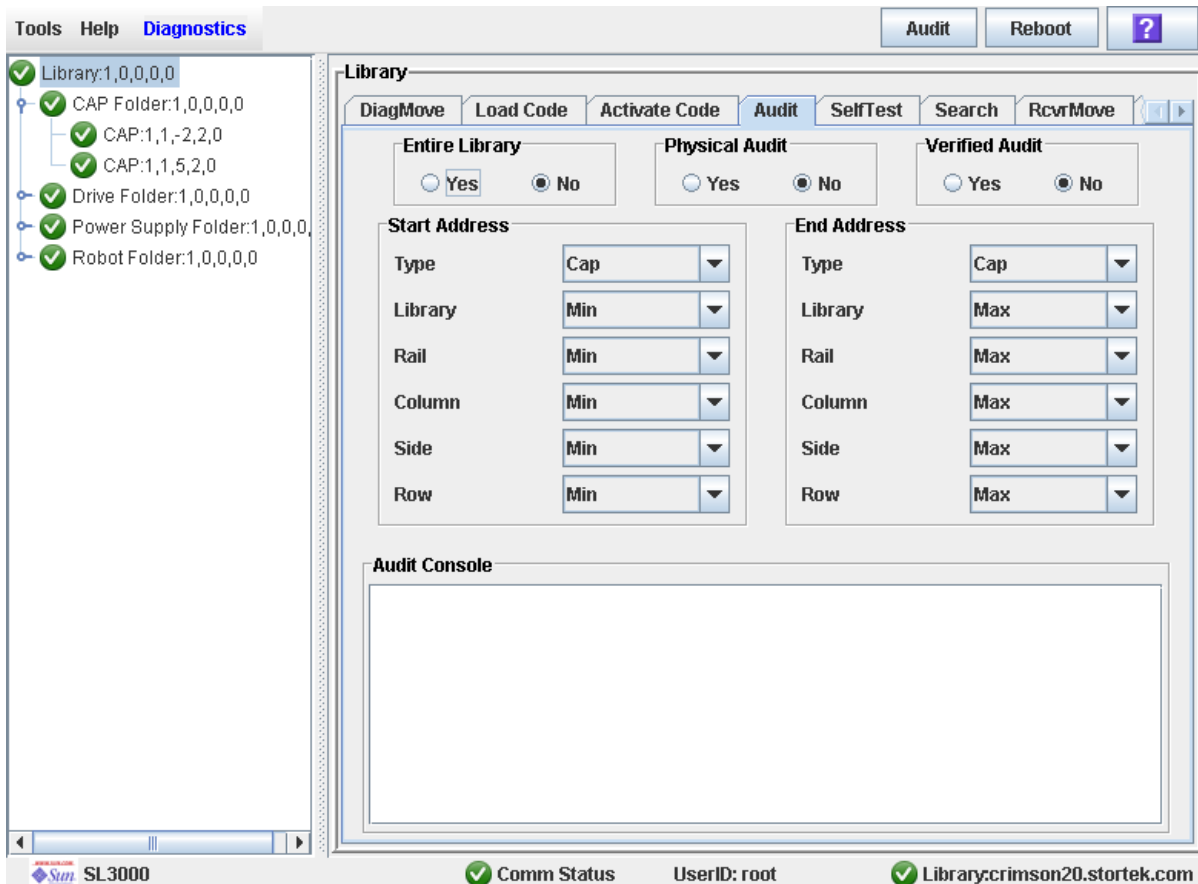

4. In the Entire Library field, click Yes. Then click the Audit button in the Options Bar.

A confirmation popup appears.

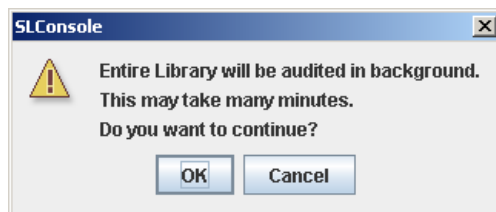

5. Click OK to perform the audit as a background process or Cancel to cancel the audit.

---

**Note** – Once you click OK, you cannot stop the audit; it will run until completion.

---

6. You can view the Cartridge Summary report after a few hours for the latest cartridge locations and VOLIDs. See [“Display a Library Report” on page 114](#) for details.

## ▼ Audit a Range of Cells

During this audit the TallBot visits only a specific range of storage cells (including the cap and drives) and updates the library controller database.

1. Select Tools > Diagnostics.
2. Click the Library folder on the device tree.

The Library screen appears.

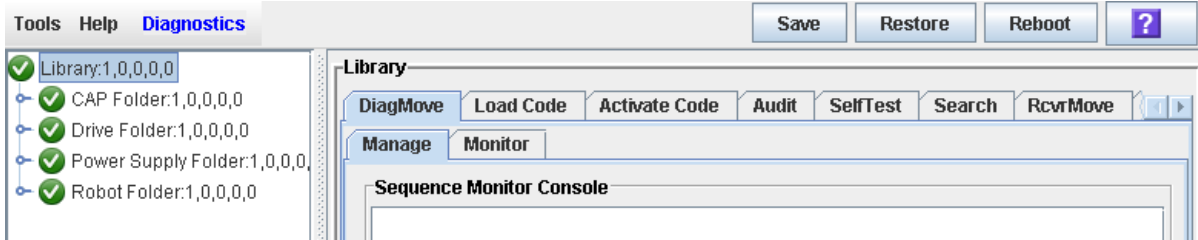

3. Click the Audit tab.

The Library Audit screen appears.

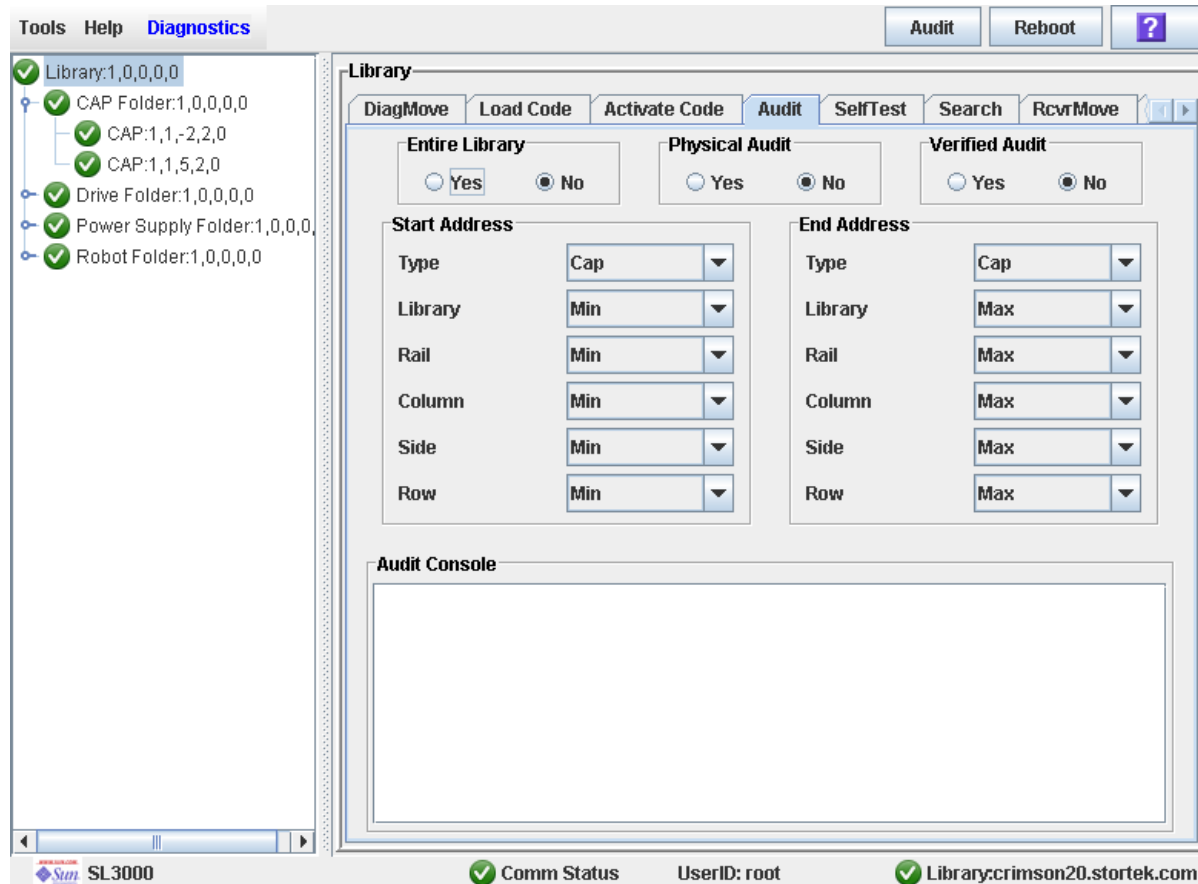

4. In the Entire Library field, click No. In the Physical Audit field, click Yes. In the Verified Audit field, click No.

- In the Start Address and End Address fields, select the device types you want to audit and the starting and ending library internal address locations. See [“Library Internal Address”](#) on page 493 for a detailed explanation of this address format.
- Click the Audit button in the Options Bar.

A confirmation popup appears.

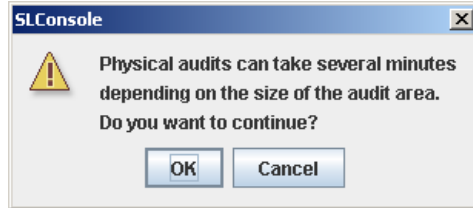

- Click OK to perform the audit as a background process or Cancel to cancel the audit.

---

**Note** – Once you click **OK**, you cannot stop the audit; it will run until completion.

---

- The Audit Console section displays the progress of the audit.

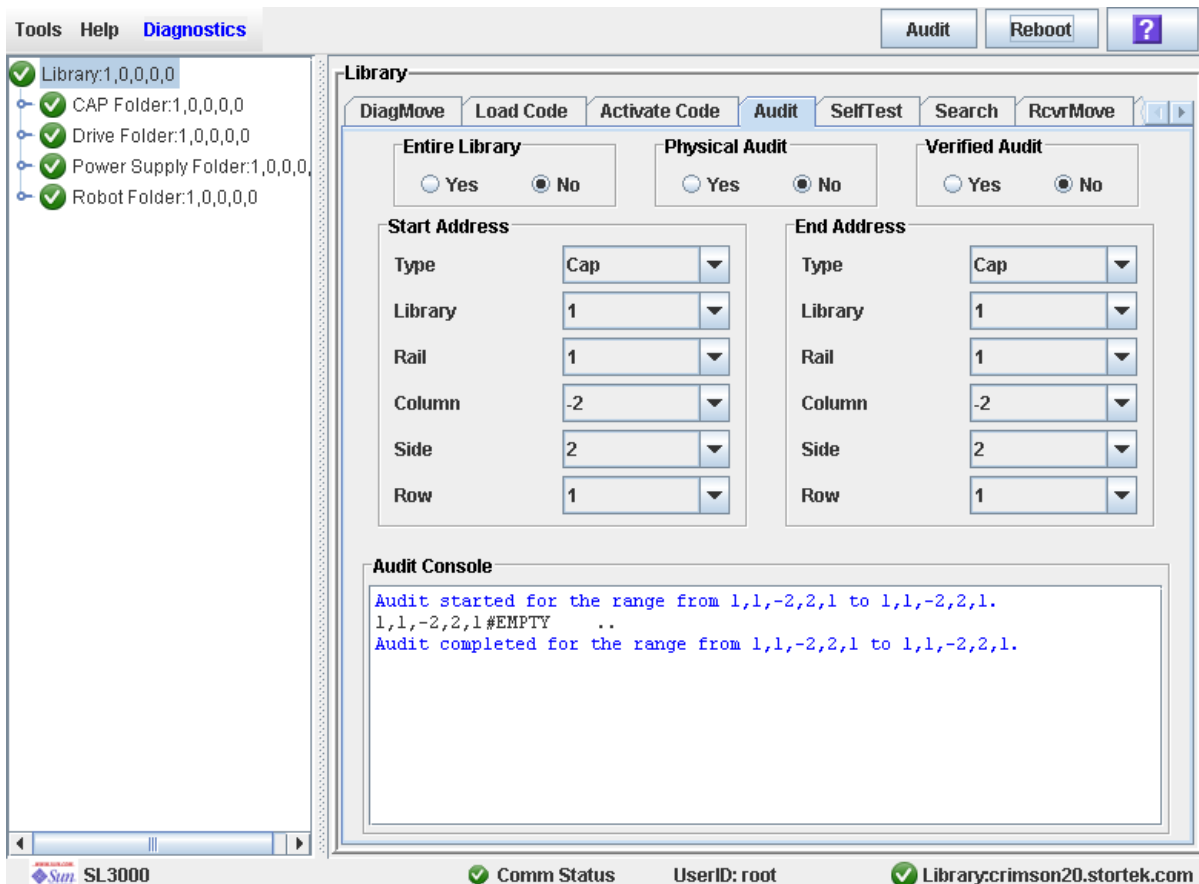

---

**Note** – You can also view the Cartridge Summary report for the latest cartridge locations and VOLIDs. See [“Display a Library Report”](#) on page 114 for details.

---

## ▼ Perform a Verified Audit

A verified audit validates the status of a specific cartridge location or a range of locations (including rotational and AEM CAPs and drives) in the library controller database. If a cartridge address has a verified status of “false” then a physical audit of that location is performed and the library controller database is updated.

1. Select Tools > Diagnostics.
2. Click the Library folder on the device tree.

The Library screen appears.

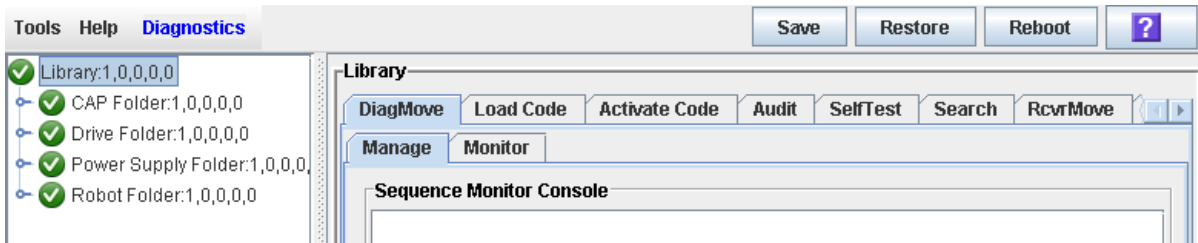

3. Click the Audit tab.

The Library Audit screen appears.

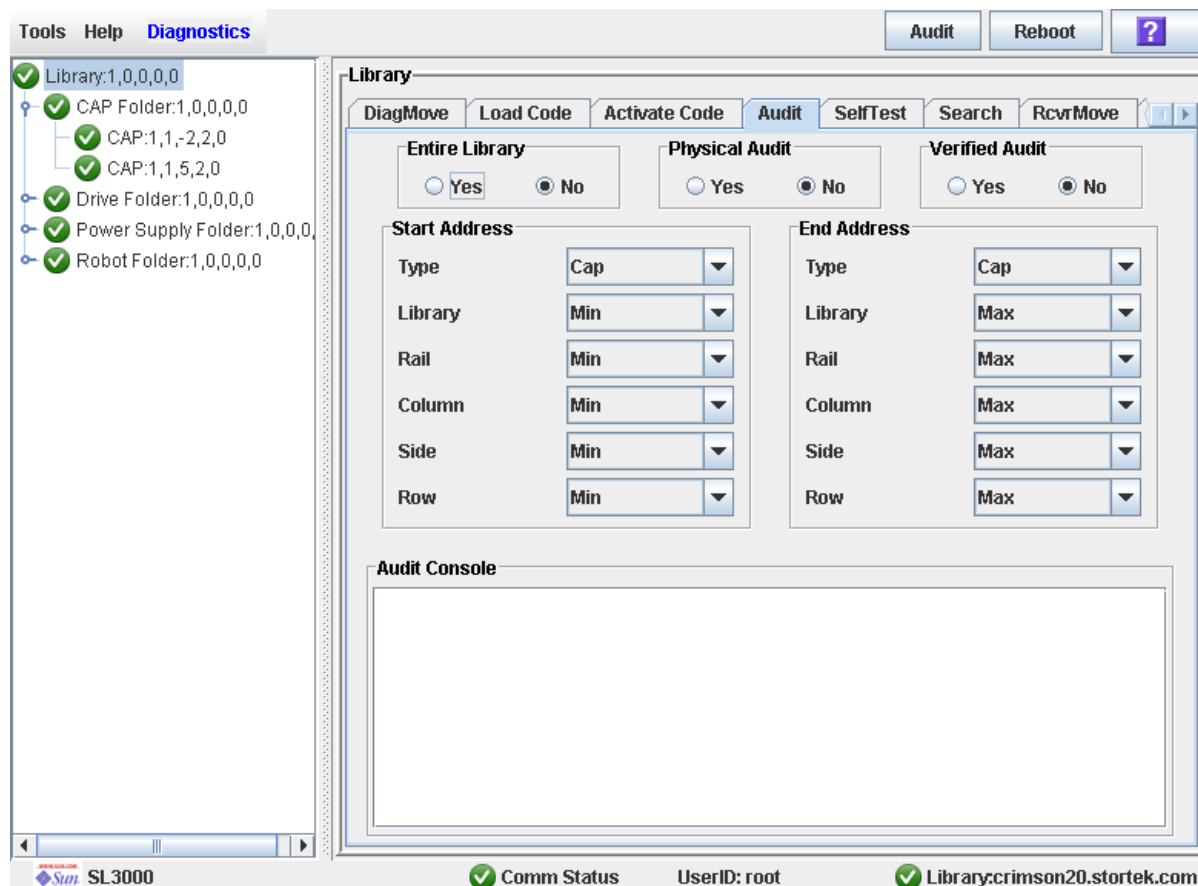

4. In the Entire Library field, click No. In the Physical Audit field, click No. In the Verified Audit field, click Yes.

5. In the Start Address and End Address fields, select the device types you want to audit and the starting and ending library internal address locations. See “Library Internal Address” on page 493 for a detailed explanation of this address format.
6. Click the Audit button in the Options Bar.

The Audit Console section displays the progress of the audit.

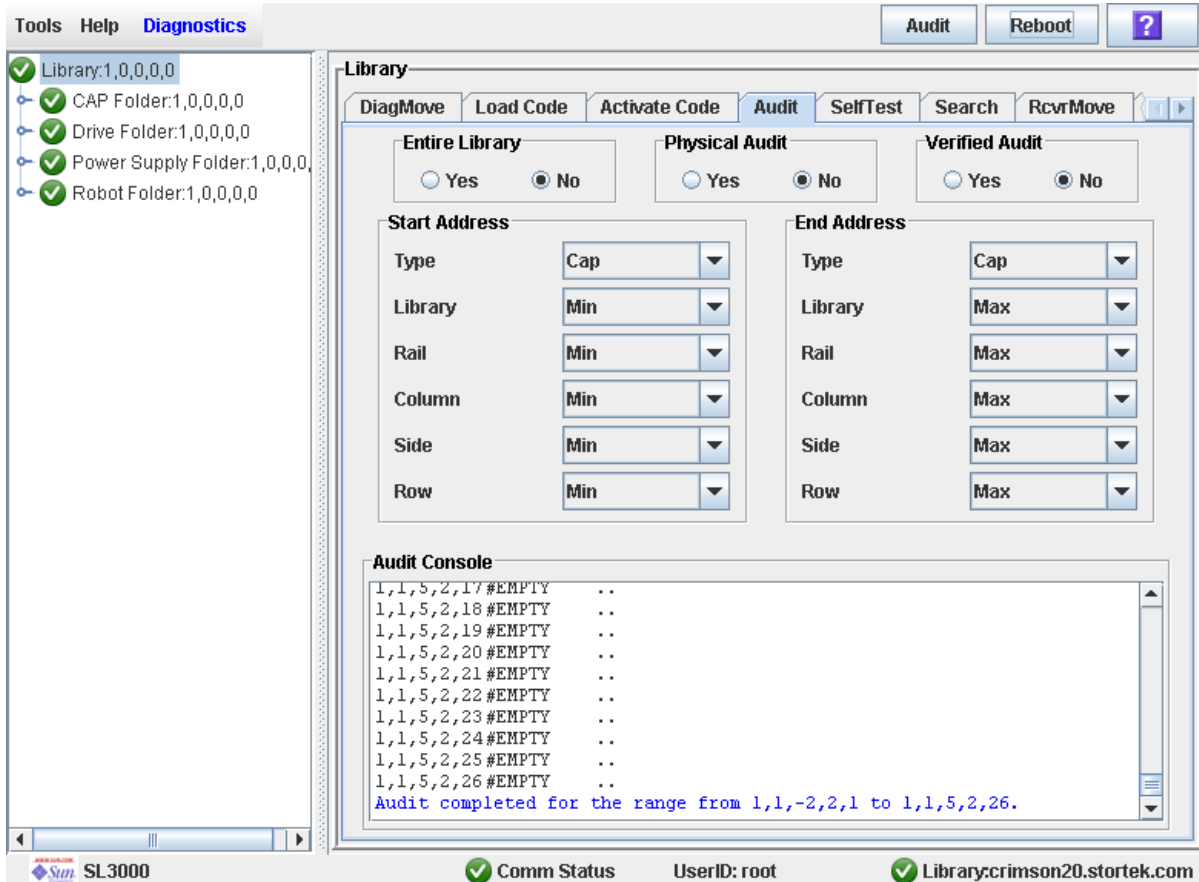

---

## Rotational and AEM CAP Utility Tasks

<b>Task</b>	<b>Page</b>
<a href="#">Perform a Self-Test on a Rotational or AEM CAP</a>	445
<a href="#">Vary a Rotational or AEM CAP Offline</a>	446
<a href="#">Vary a Rotational or AEM CAP Online</a>	448



## ▼ Perform a Self-Test on a Rotational or AEM CAP

---

**Note** – At present, the CAP self-tests perform the same routines as the library self-test. Specific rotational and AEM CAP self-tests will be available at a later date.

---

1. **Select Tools > Diagnostics.**
2. **Expand the CAP folder, and click the CAP you want to test.**

---

**Note** – AEM CAPs are identified as follows: column “-31” for a left AEM CAP, and column “31” for a right AEM CAP.

---

3. **Click the SelfTest tab.**
4. **In the Mode pull-down menu, click Non-Disruptive.**
5. **Click the Run button from the Options Bar.**

Status messages are displayed as the self-test is run. A Diagnostic completed message appears when the test finishes.

## ▼ Vary a Rotational or AEM CAP Offline

Use this procedure to vary a rotational or AEM CAP offline through the SL Console.

**Note** – You should use this procedure only if you are not using ACSLS or HSC tape management software, or if their servers are not able to communicate with the library. ACSLS and HSC are not notified when the state of the library or its components are changed through the SL Console, possibly leading to disruption in library operations. For instructions on changing the state of the library and its components through ACSLS or HSC, see the appropriate tape management software documentation.

1. Select **Tools > System Detail**.
2. Expand the **CAP Folder**, and click the CAP you want to modify.

**Note** – AEM CAPs are identified as follows: column “-31” for a left AEM CAP, and column “31” for a right AEM CAP.

3. Click the **Status** tab.

The screen displays the current status of the CAP.

The screenshot shows the SL3000 System Detail window. The left pane shows a tree view of the library structure, with the CAP folder expanded and the CAP:1,1,11,2,0 selected. The main pane shows the CAP Status and CAP Cartridges sections.

**CAP Status**

Transition Request	-select-transition-
Health State	ok
Device State	Ready
Access State	online
Locked	false
Mode	idle
CAP Door	closed
Reserved	true
Reserver	scsi0
Association	scsi0

**CAP Cartridges**

Cartridge	Location
EN19350R	1,1,11,2,7
EN28670R	1,1,11,2,16
EN39540R	1,1,11,2,26

The status bar at the bottom shows: SL3000, Comm Status (green checkmark), UserID: root, and Library:crimson6.central.sun.com (green checkmark).

**4. In the Transition Request field, click Take Offline. Click Apply.**

All outstanding jobs for the CAP are completed, and then the CAP status is changed, as follows:

- Health State: Warn
- Device State: Not accessible (HLI host connections); Not ready (SCSI host connections)
- Access State: Offline

## ▼ Vary a Rotational or AEM CAP Online

Use this procedure to vary a rotational or AEM CAP online through the SL Console.

---

**Note** – You should use this procedure only if you are not using ACSLS or HSC tape management software, or if their servers are not able to communicate with the library. ACSLS and HSC are not notified when the state of the library or its components are changed through the SL Console, possibly leading to disruption in library operations. For instructions on changing the state of the library and its components through ACSLS or HSC, see the appropriate tape management software documentation.

---

---

**Note** – Library devices that are offline in an error state cannot go online; the error condition must be cleared first.

---

1. Select **Tools > System Detail**.
2. Expand the **CAP Folder**, and click the **CAP** you want to modify.

---

**Note** – AEM CAPs are identified as follows: column “-31” for a left AEM CAP, and column “31” for a right AEM CAP.

---

### 3. Click the Status tab.

The screen displays the current status of the CAP.

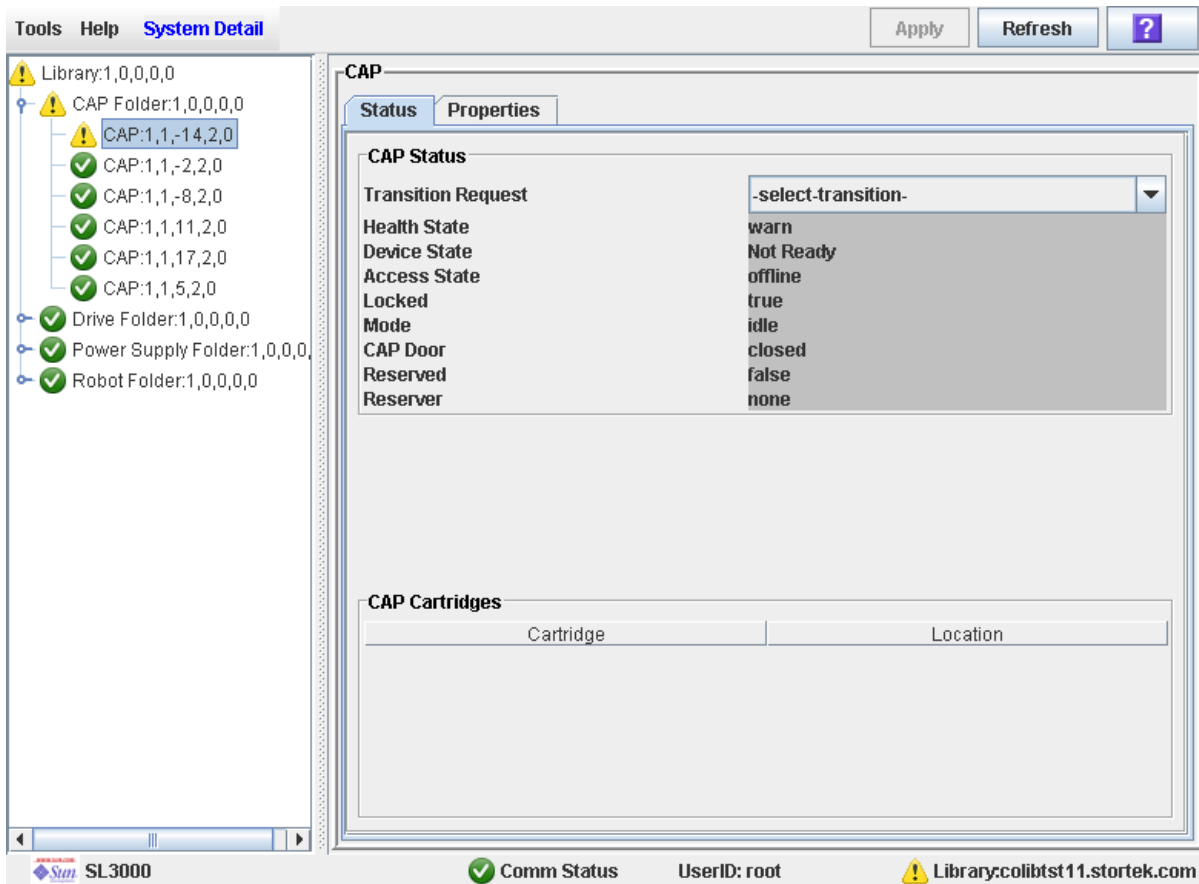

### 4. In the Transition Request field, click Bring online. Click Apply.

The CAP status is updated, as follows:

- Health State: ok
- Device State: Ready
- Access State: Online

---

# Drive Utility Tasks

<b>Task</b>	<b>Page</b>
<a href="#">Perform a Drive Self-Test</a>	451
<a href="#">Vary a Drive Offline</a>	452
<a href="#">Vary a Drive Online</a>	453

## ▼ Perform a Drive Self-Test

1. **Select Tools > Diagnostics.**
2. **Expand the Drive Folder, and click the drive you want to test.**
3. **Click the SelfTest tab.**
4. **In the Mode pull-down, click Non-Disruptive.**
5. **Click the Run button from the Options Bar.**

Status messages are displayed as the self-test is run. A Diagnostic completed message appears when the test finishes.

## ▼ Vary a Drive Offline

Use this procedure to vary a drive offline through the SL Console.

---

**Note** – You should use this procedure only if you are not using ACSLS or HSC tape management software, or if their servers are not able to communicate with the library. ACSLS and HSC are not notified when the state of the library or its components are changed through the SL Console, possibly leading to disruption in library operations. For instructions on changing the state of the library and its components through ACSLS or HSC, see the appropriate tape management software documentation.

---

1. Select **Tools > System Detail**.
2. Expand the **Drive Folder**, and click the drive you want to modify.
3. Click the **Status** tab.

The screen displays the current status of the drive.

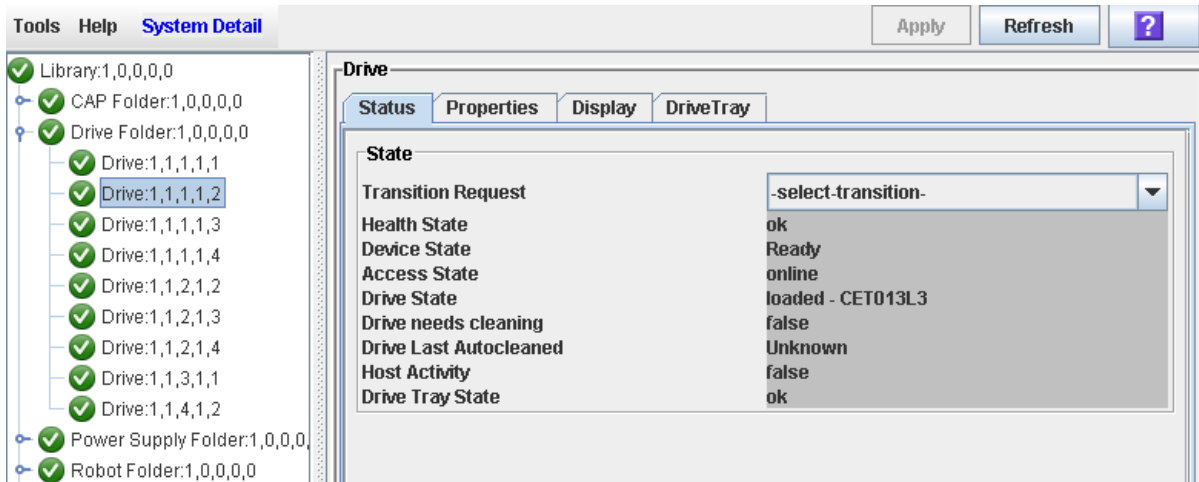

4. In the **Transition Request** field, click **Take Offline**. Click **Apply**.

All outstanding jobs for the drive are completed, and then the drive status is changed, as follows:

- Health State: Warn
- Device State: Not accessible (HLI host connections); Not ready (SCSI host connections)
- Access State: Offline



## ▼ Vary a Drive Online

Use this procedure to vary a drive online through the SL Console.

---

**Note** – You should use this procedure only if you are not using ACSLS or HSC tape management software, or if their servers are not able to communicate with the library. ACSLS and HSC are not notified when the state of the library or its components are changed through the SL Console, possibly leading to disruption in library operations. For instructions on changing the state of the library and its components through ACSLS or HSC, see the appropriate tape management software documentation.

---



---

**Note** – Library devices that are offline in an error state cannot go online; the error condition must be cleared first.

---

1. Select **Tools > System Detail**.
2. Expand the **Drive Folder**, and click the drive you want to modify.
3. Click the **Status** tab.

The screen displays the current status of the drive.

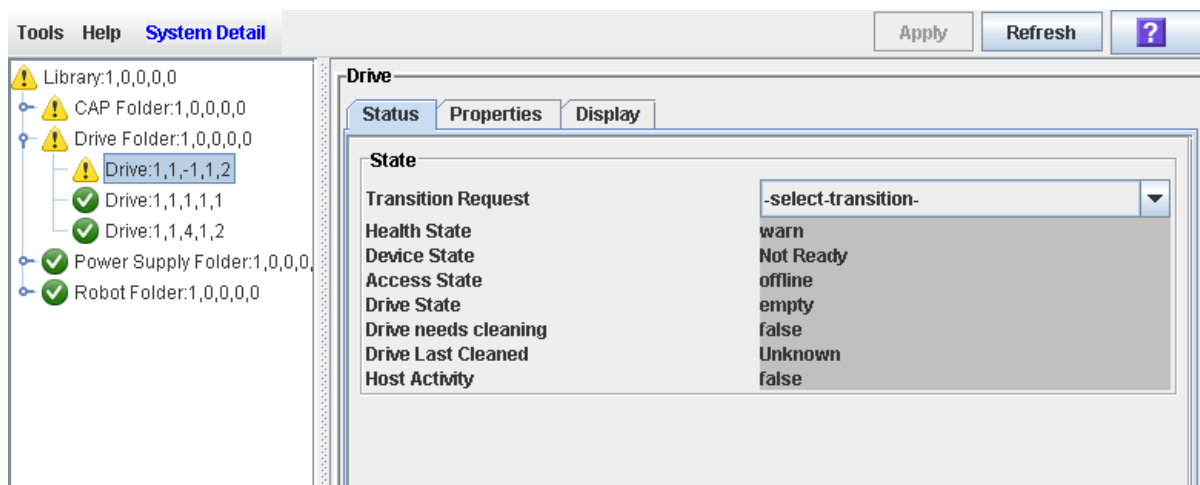

4. In the **Transition Request** field, click **Bring online**. Click **Apply**.

The drive status is updated, as follows:

- Health State: ok
- Device State: Ready
- Access State: Online

---

# TallBot Utility Tasks

<b>Task</b>	<b>Page</b>
<a href="#">Perform a TallBot Self-Test</a>	455
<a href="#">Vary a TallBot Offline</a>	456
<a href="#">Vary a TallBot Online</a>	457
<a href="#">Define a Diagnostic Move</a>	458
<a href="#">Manage Diagnostic Move Definitions</a>	463
<a href="#">Save a Diagnostic Move to a File</a>	465
<a href="#">Start a Diagnostic Move</a>	467
<a href="#">Monitor and Control Open Diagnostic Moves</a>	469

## ▼ Perform a TallBot Self-Test

---

**Note** – To perform a TallBot self-test, diagnostic cartridges must be available in the library.

---

1. **Select Tools > Diagnostics.**
2. **Expand the Robot Folder, and click the robot you want to test.**
3. **Click the SelfTest tab.**
4. **In the Mode pull-down, click Non-Disruptive.**
5. **Click the Run button from the Options Bar.**

Status messages are displayed as the self-test is run. A Diagnostic completed message appears when the test finishes.

## ▼ Vary a TallBot Offline

Use this procedure to vary a TallBot offline through the SL Console.

---

**Note** – You should use this procedure only if you are not using ACSLS or HSC tape management software, or if their servers are not able to communicate with the library. ACSLS and HSC are not notified when the state of the library or its components are changed through the SL Console, possibly leading to disruption in library operations. For instructions on changing the state of the library and its components through ACSLS or HSC, see the appropriate tape management software documentation.

---

1. Select **Tools > System Detail**.
2. Expand the **Robot Folder**, and click the TallBot you want to modify.
3. Click the **Status** tab.

The screen displays the current status of the TallBot.

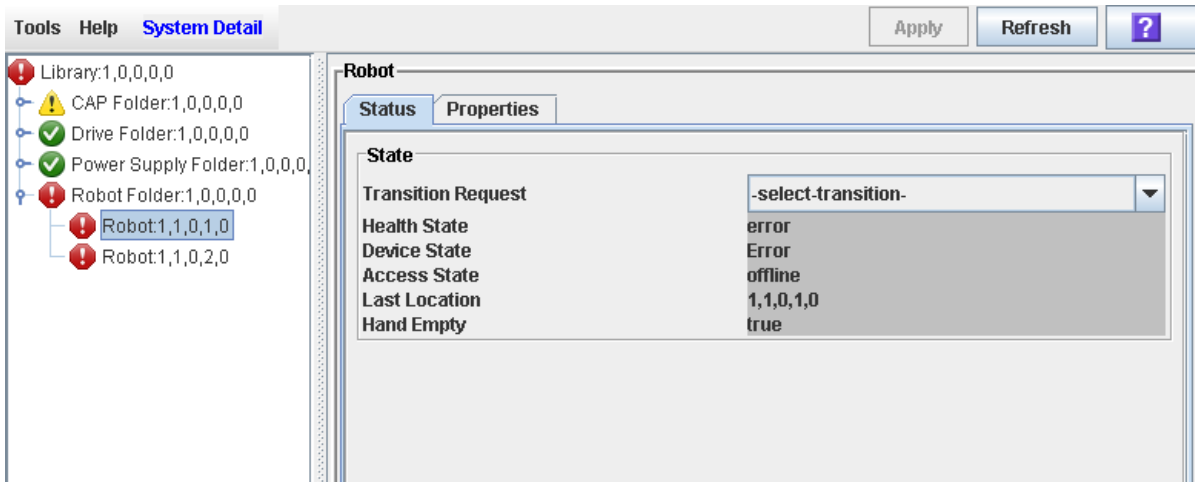

4. In the **Transition Request** field, click **Take Offline**. Click **Apply**.  
All outstanding jobs for the TallBot are completed, and then the TallBot status is changed, as follows:
  - Health State: Warn
  - Device State: Not accessible (HLI host connections); Not ready (SCSI host connections)
  - Access State: Offline
5. The TallBot is moved to the end of the rail and is not usable by the library. If the library is using the redundant TallBot feature, the second TallBot will take all requests.

## ▼ Vary a TallBot Online

Use this procedure to vary a TallBot online through the SL Console.

---

**Note** – You should use this procedure only if you are not using ACSLS or HSC tape management software, or if their servers are not able to communicate with the library. ACSLS and HSC are not notified when the state of the library or its components are changed through the SL Console, possibly leading to disruption in library operations. For instructions on changing the state of the library and its components through ACSLS or HSC, see the appropriate tape management software documentation.

---



---

**Note** – Library devices that are offline in an error state cannot go online; the error condition must be cleared first.

---

1. Select **Tools > System Detail**.
2. Expand the **Robot Folder**, and click the **TallBot** you want to modify.
3. Click the **Status** tab.

The screen displays the current status of the TallBot.

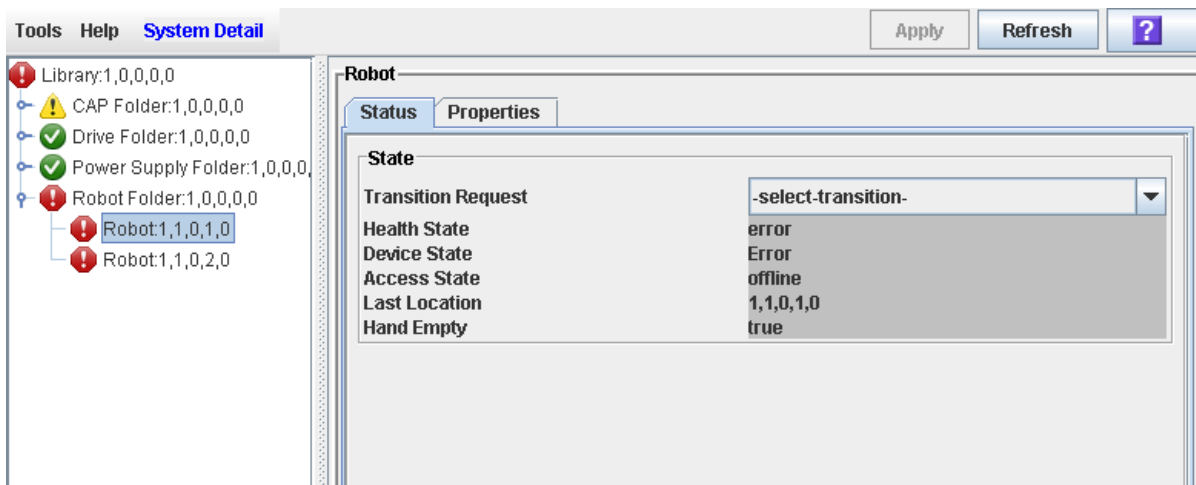

4. In the **Transition Request** field, click **Bring Online**. Click **Apply**.

The TallBot status is updated, as follows:

- Health State: ok
- Device State: Ready
- Access State: Online

## ▼ Define a Diagnostic Move

Multiple diagnostic move routines can be set up and run simultaneously, as long as the target and pool address ranges do not overlap.

---

**Note** – This procedure requires sharing of TallBot resources; therefore, it is not recommended that you run it during peak activity periods.

---

1. Select Tools > Diagnostics.
2. Click the Library folder on the device tree.

The Library screen appears.

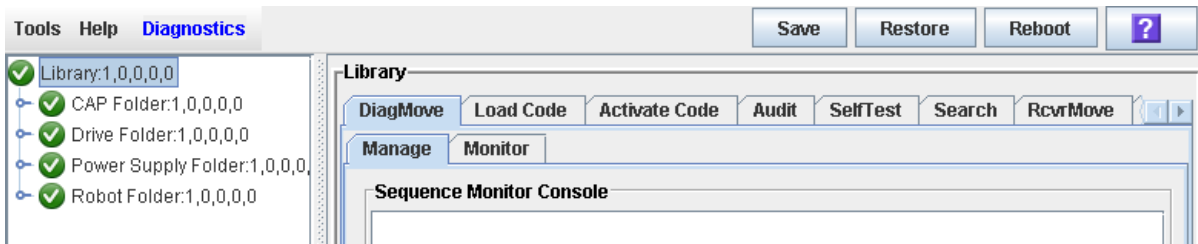

3. Click the DiagMove tab and then the Manage tab.

The Diagnostic Move Manage screen appears.

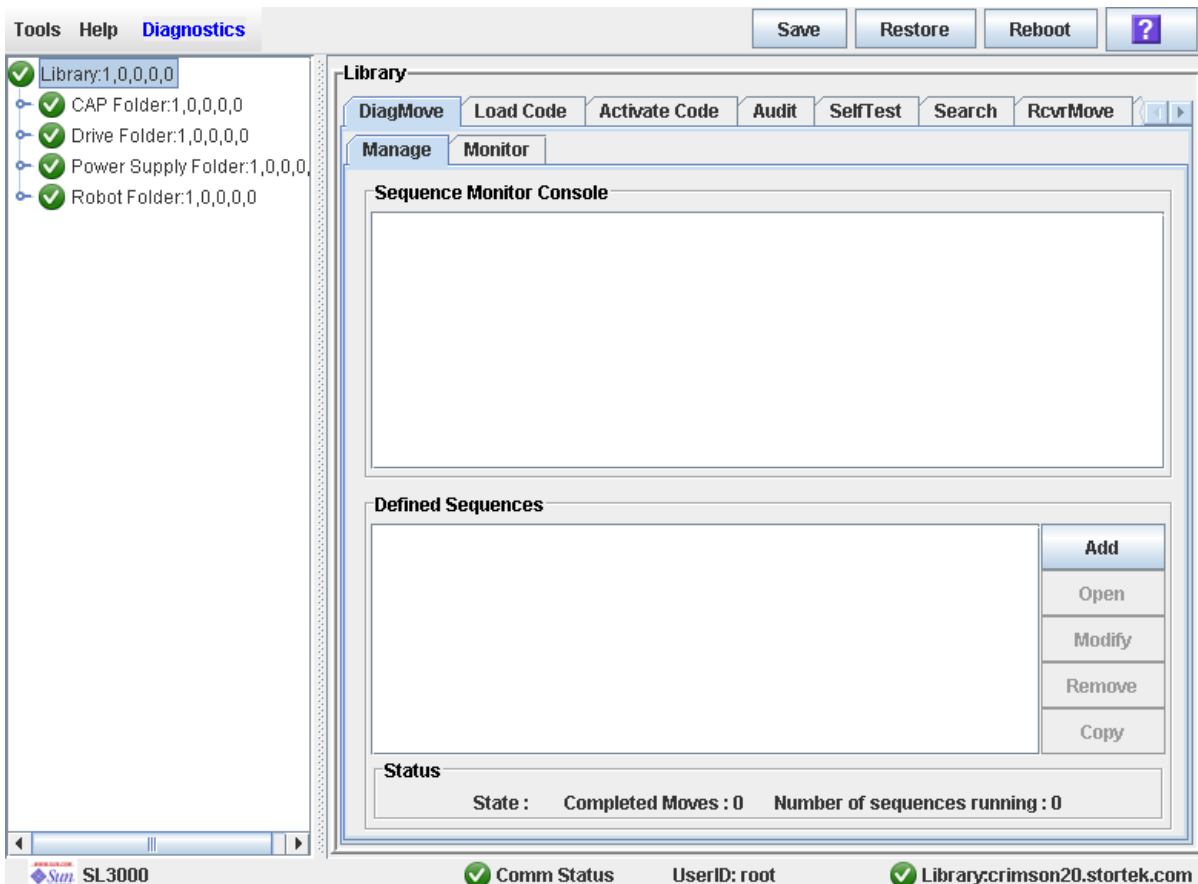

4. In the Defined Sequence section, click Add.

The TARGET screen appears.

**SLConsole - Sequence**

**Enter TARGET address range:**  
All slots within this range will be accessed according to the Access Order specified in the last dialog box.

**Selection Mode**

All
  Storage Slots  
 Drive
  Drive & Storage Slots  
 Cap
  System Slots

**Minimum Address**

Library	Min
Rail	Min
Column	Min
Side	Min
Row	Min

**Maximum Address**

Library	Max
Rail	Max
Column	Max
Side	Max
Row	Max

Next > Cancel

5. Complete the TARGET screen as follows. See [“Target Address Range”](#) on page 410 for details.

- In the **Selection Mode** field, click the type of cells you want to diagnose.
- In the **Minimum Address** and **Maximum Address** fields, select the library internal address of the starting and ending locations of the cells you want to diagnose.

6. Click Next.

The **SOURCE** screen appears.

7. Complete the **SOURCE** screen as follows. See [“Pool Address Range”](#) on page 410 for details.

- In the **Selection Mode** field, click the appropriate cartridge pool address type.
- In the **Minimum Address** and **Maximum Address** fields, select the library internal addresses of the starting and ending locations of the cartridge pool you want to use.



**8. Click Next.**

The **Sequence** screen appears.

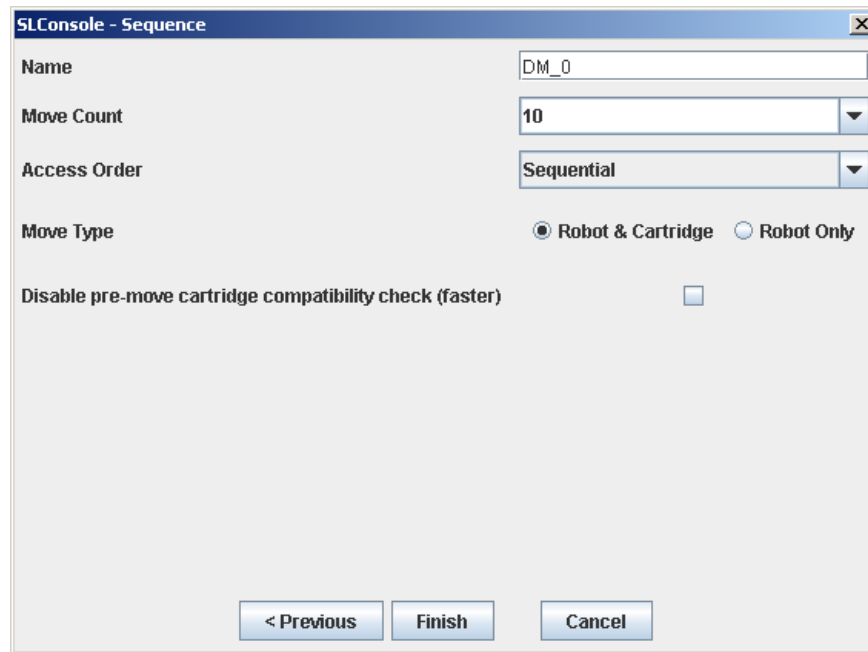

The screenshot shows a dialog box titled "SLConsole - Sequence". It contains the following fields and options:

- Name:** A text box containing "DM\_0".
- Move Count:** A dropdown menu showing "10".
- Access Order:** A dropdown menu showing "Sequential".
- Move Type:** Two radio buttons: "Robot & Cartridge" (selected) and "Robot Only".
- Disable pre-move cartridge compatibility check (faster):** An unchecked checkbox.
- Buttons:** "< Previous", "Finish", and "Cancel" buttons at the bottom.

**9. Complete the Sequence screen as follows. See [“Move Access Order”](#) on page 411 for details.**

- Name of the diagnostic move
- Move Count (specify a number between 1 and 5000)
- Access order (Sequential or Random)
- Move Type (Robot and Cartridge or Robot Only)
- Disable pre move cartridge compatibility check

10. Click **Finish** to complete the setup.

The **Diagnostic Move Manage** screen appears. The diagnostic sequence you have just defined is listed in the **Defined Sequences** section.

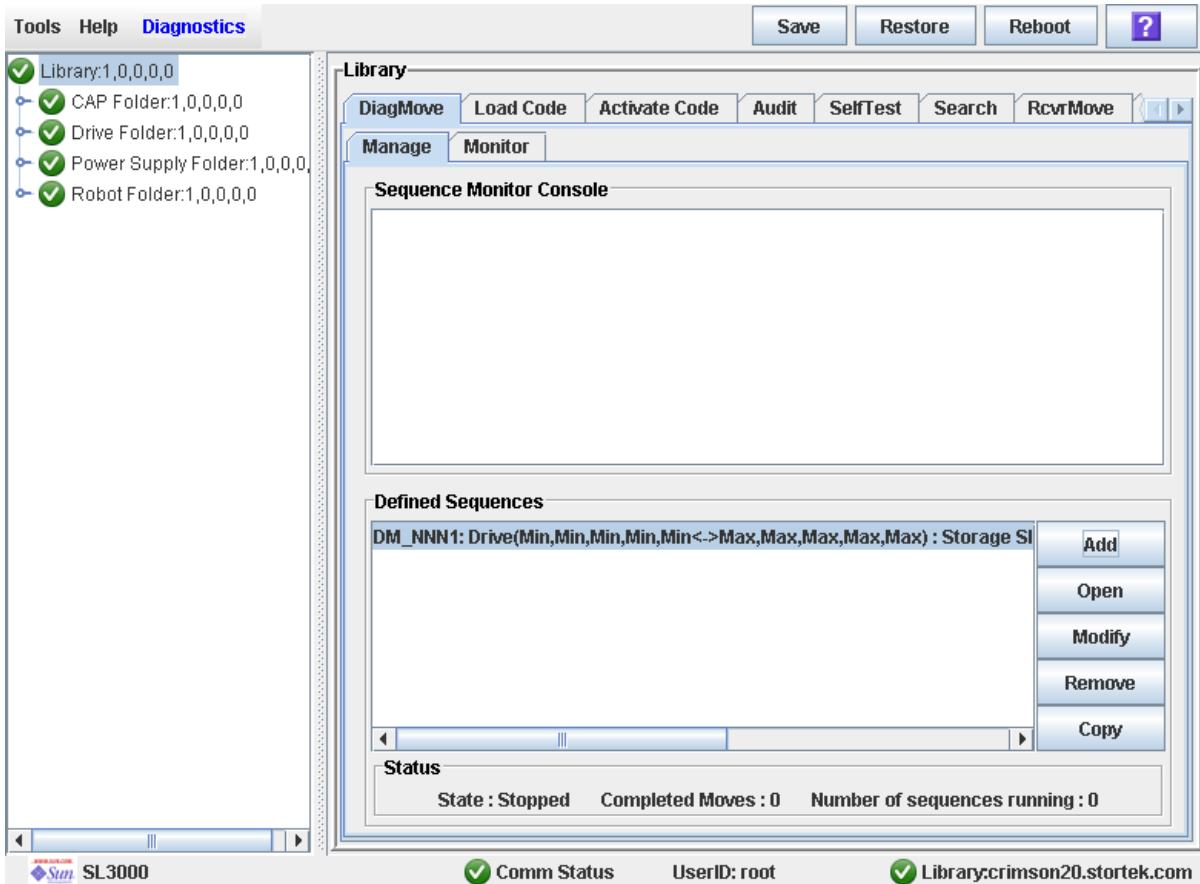

## ▼ Manage Diagnostic Move Definitions

Use this procedure to manage diagnostic move sequence definitions.

1. Select **Tools > Diagnostics**.
2. Click the **Library** folder on the device tree.

The **Library** screen appears.

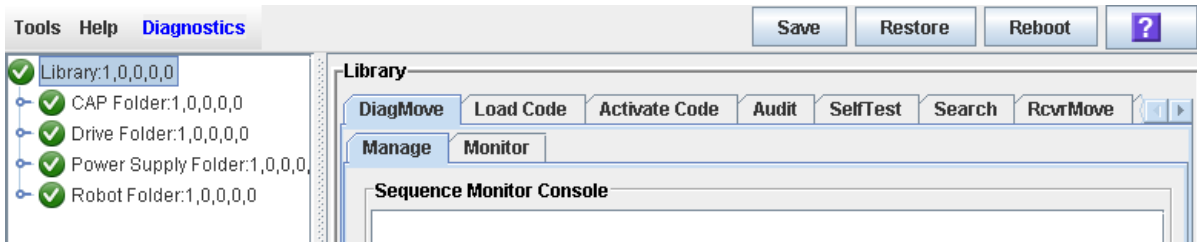

3. Click the **DiagMove** tab and then the **Manage** tab.

The **Diagnostic Move Manage** screen appears.

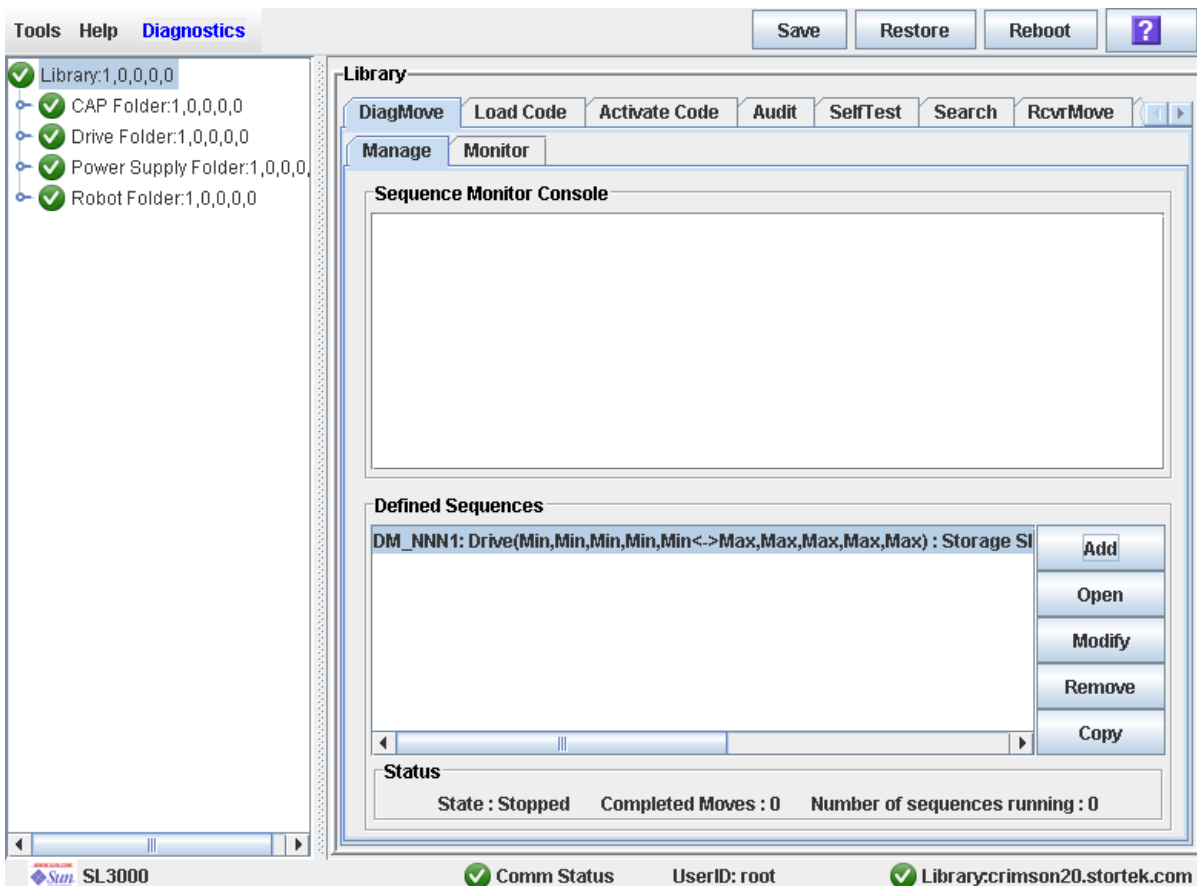

4. From the Defined Sequences section, select any of the following options:

Select Option	To	Notes
Add	Define a diagnostic move	
Open	Start a diagnostic move	Multiple diagnostic moves may be open at a time, so long as the target and pool address ranges setup for the moves do not overlap.
Modify	Modify options for a diagnostic move	This diagnostic move routine must not be open or if open must be in a "Stopped" state.
Remove	Remove a diagnostic move	This diagnostic move routine must not be open.
Copy	Copy an existing diagnostic move	Copy a diagnostic move definition, make changes if necessary, and assign a different name.

5. To manage the diagnostic moves currently open, see ["Monitor and Control Open Diagnostic Moves"](#) on page 469.

## ▼ Save a Diagnostic Move to a File

Use this procedure to save a defined diagnostic move to a local file on your workstation or PC. The file is saved as a JavaBean component represented as an XML 1.0 document (.xml).

Possible uses for the saved file are:

- Can be used to restore a move that has been deleted from the library.
- Can be copied to a different library for use there.

1. Select **Tools > Diagnostics**.
2. Click the **Library** folder on the device tree.

The **Library** screen appears.

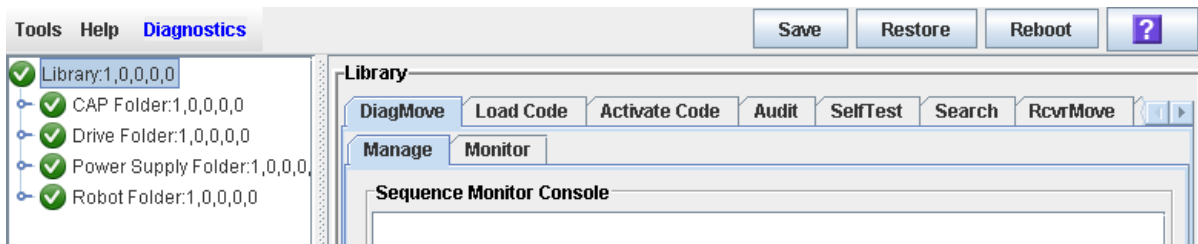

3. Click the **DiagMove** tab and then the **Manage** tab.

The **Diagnostic Move Manage** screen appears.

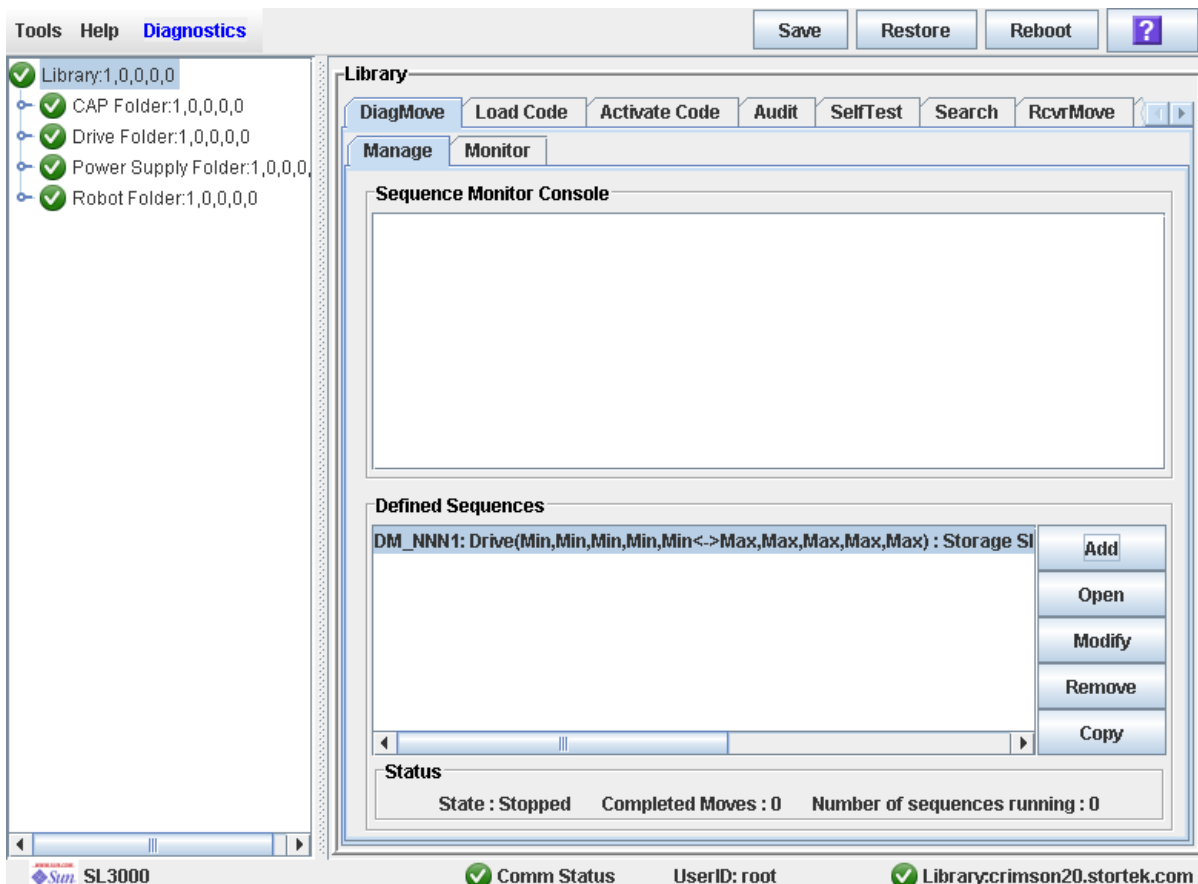

- Click the diagnostic move you want to save, and then click the Save button in the Options Bar.

The Save popup appears.

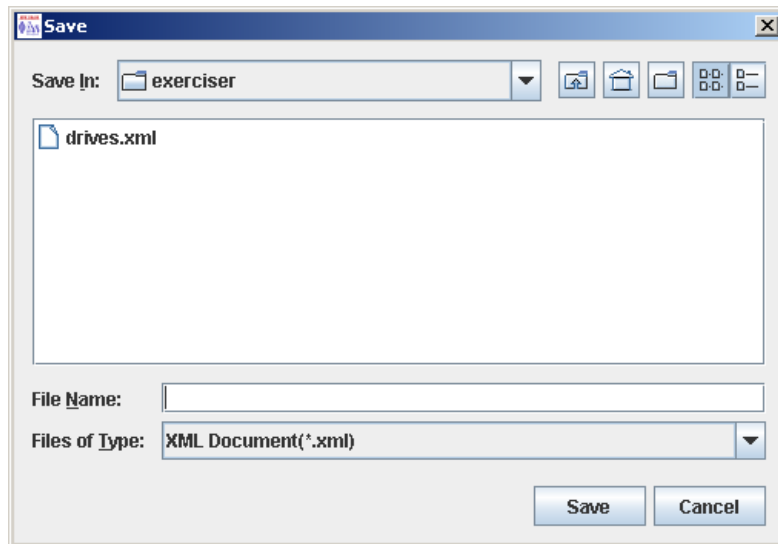

- Browse to the directory where you want to save the file. In the File Name field, enter the file name.
- Click Save.

The data is saved to the specified file. Following is a sample excerpt:

```
<?xml version="1.0" encoding="UTF-8"?>
<java version="1.5.0_11" class="java.beans.XMLDecoder">
  <object class="com.stortek.ats.elib.opel.model.SequenceBeanList">
    <string>FRS_4.10</string>
    <string>SL500</string>
    <void method="add">
      <object class=
"com.stortek.ats.elib.opel.model.SequenceBeanList$SequenceBean">
        <void property="accessOrder">
          <string>Sequential</string>
        </void>
        <void property="moveCartridge">
          <boolean>true</boolean>
        </void>
        <void property="moveCount">
          <int>10</int>
        </void>
        <void property="name">
          <string>DriveDiagMove1</string>
        </void>
        . . .
        <void property="targetType">
          <string>Drive</string>
        </void>
      </object>
    </void>
  </object>
</java>
```

## ▼ Start a Diagnostic Move

1. Select Tools > Diagnostics.
2. Click the Library folder on the device tree.

The Library screen appears.

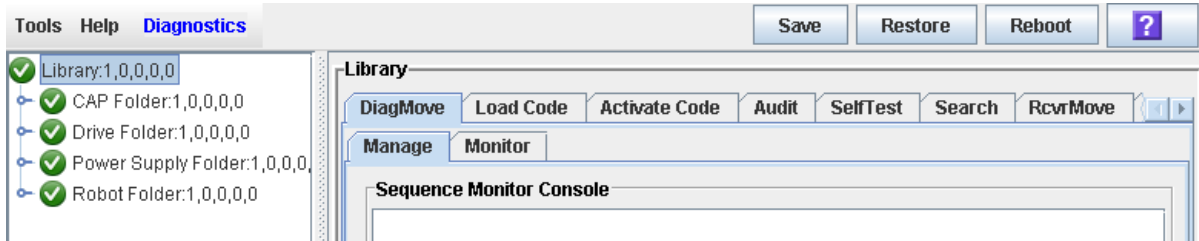

3. Click the DiagMove tab and then the Manage tab.

The Diagnostic Move Manage screen appears.

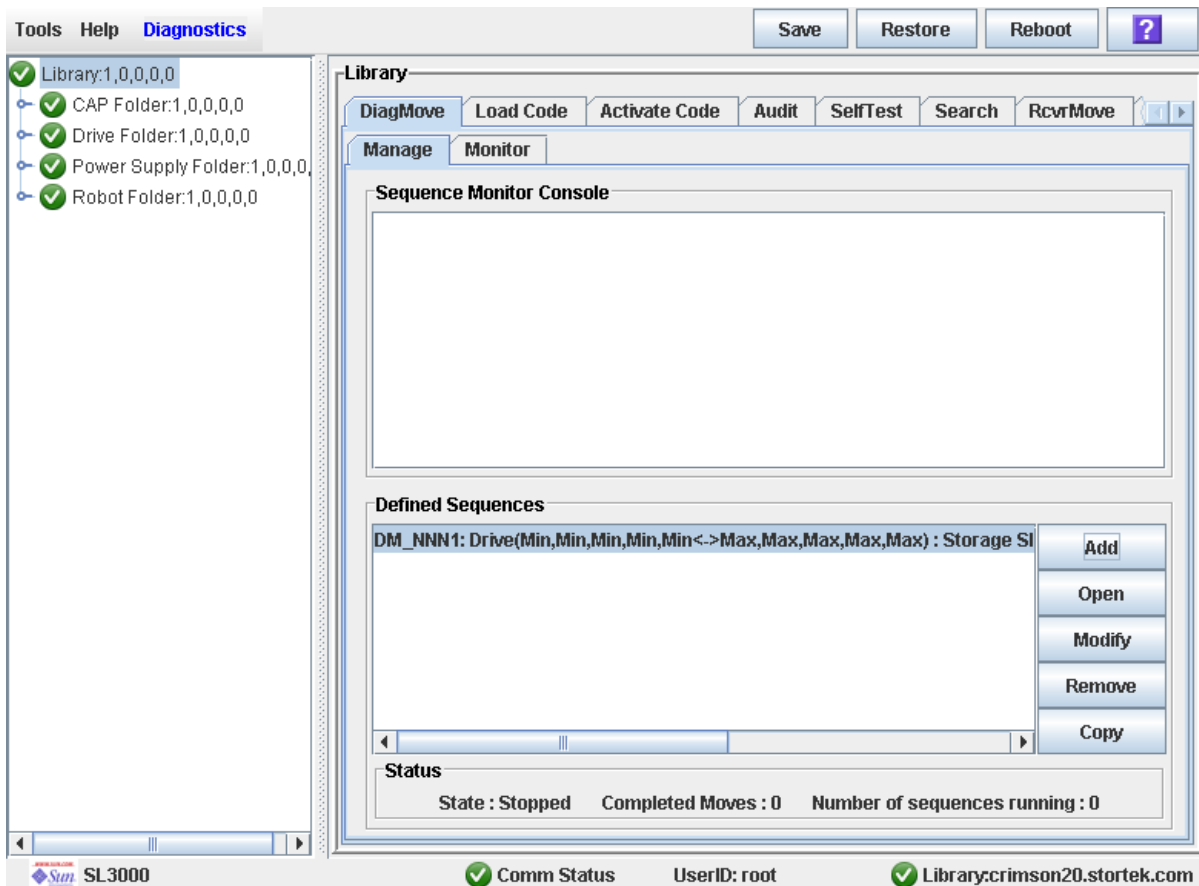

4. From the Defined Sequences section click a diagnostic move and then click Open.

The Monitor window is activated.

You can repeat this step to open multiple moves, as long as the target and pool address ranges for the moves do not overlap.

A monitor window is displayed for each move you open.

5. From each monitor window, select File > Start Sequence to start the move.



## ▼ Monitor and Control Open Diagnostic Moves

Use this procedure to control and monitor the status of one or more open diagnostic moves.

1. See [“Start a Diagnostic Move” on page 467](#) for instructions on starting one or more diagnostic moves.
2. Click the Monitor tab.

The Monitor screen appears, with one monitor window for each open move.

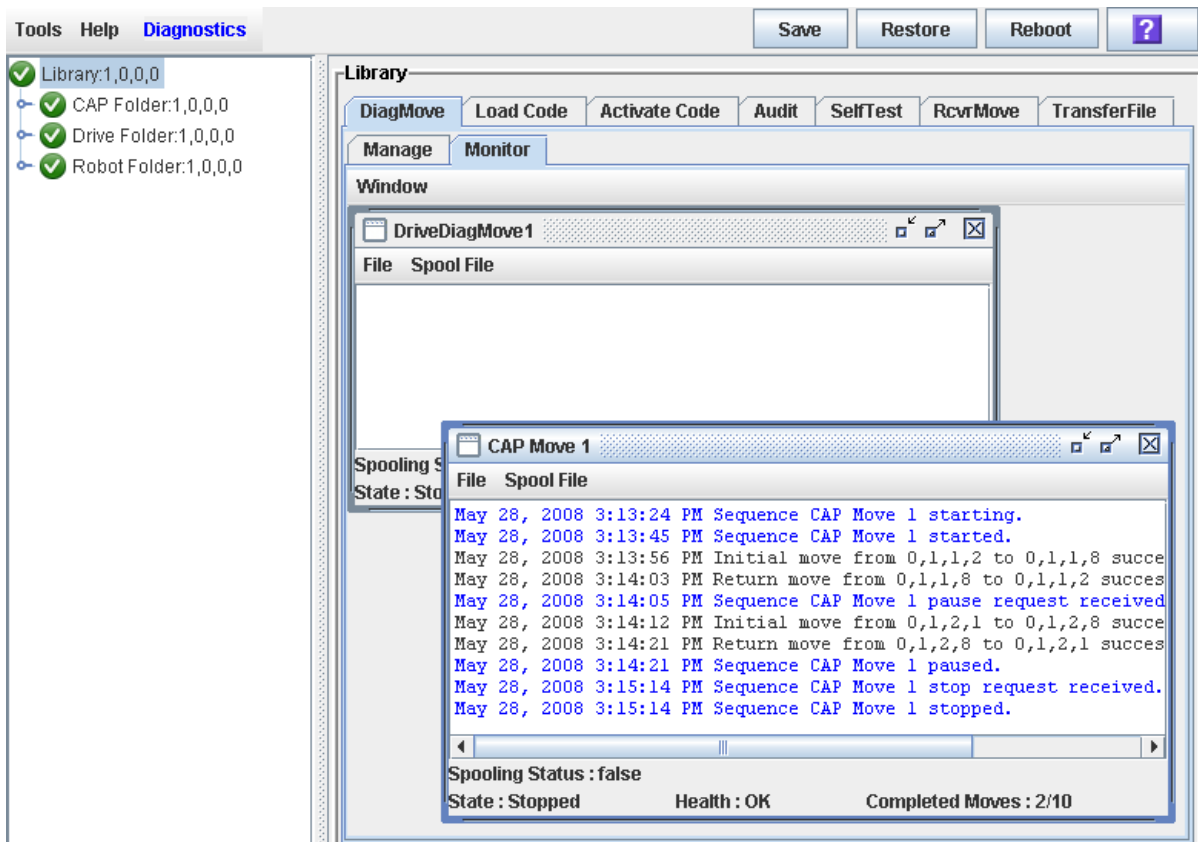

Each monitor window has the following status indicators:

Status Indicators	Description	Valid Values
Spooling Status	Indicates if the move output is being spooled to a file	True, False
State	Current execution state of the move	Running, pausing, paused, stopping, stopped
Health	Current health state of the move	OK, warning, error
Completed moves	Number of moves completed in the requested move count	

**3. Use the File menu in each Monitor window to perform any of the following functions:**

<b>Select Option</b>	<b>To</b>	<b>Notes</b>
File > Start Sequence	Start	
File > Pause Sequence	Pause	Stops all diagnostic moves, but maintains the current location in the access order.
File > Stop Sequence	Stop	Stops a running or paused move.
File > Start Sequence	Resume	Resumes a paused move starting with the last known location in the target address range.
File > Clear Output Window	Clear the messages displayed in the monitor window	Erases the previous message lines and continues to fill the screen with new messages.
Spool File > Start Spooling	Spool	Directs the move output to a file.
Spool File > Stop Spooling	Stop spooling the move output to a file	Stops directing the move output to the spool file.

---

# AEM Safety Door Utility Tasks

<b>Task</b>	<b>Page</b>
<a href="#">Reboot an AEM Safety Door</a>	472

## ▼ Reboot an AEM Safety Door

Use this procedure to reboot an AEM safety door. You may need to do this to clear errors if the AEM safety door has experienced an abnormal condition.

1. Select **Tools > Diagnostics**.
2. Expand the **Safety Door Folder**, and click the AEM safety door you want to reboot.

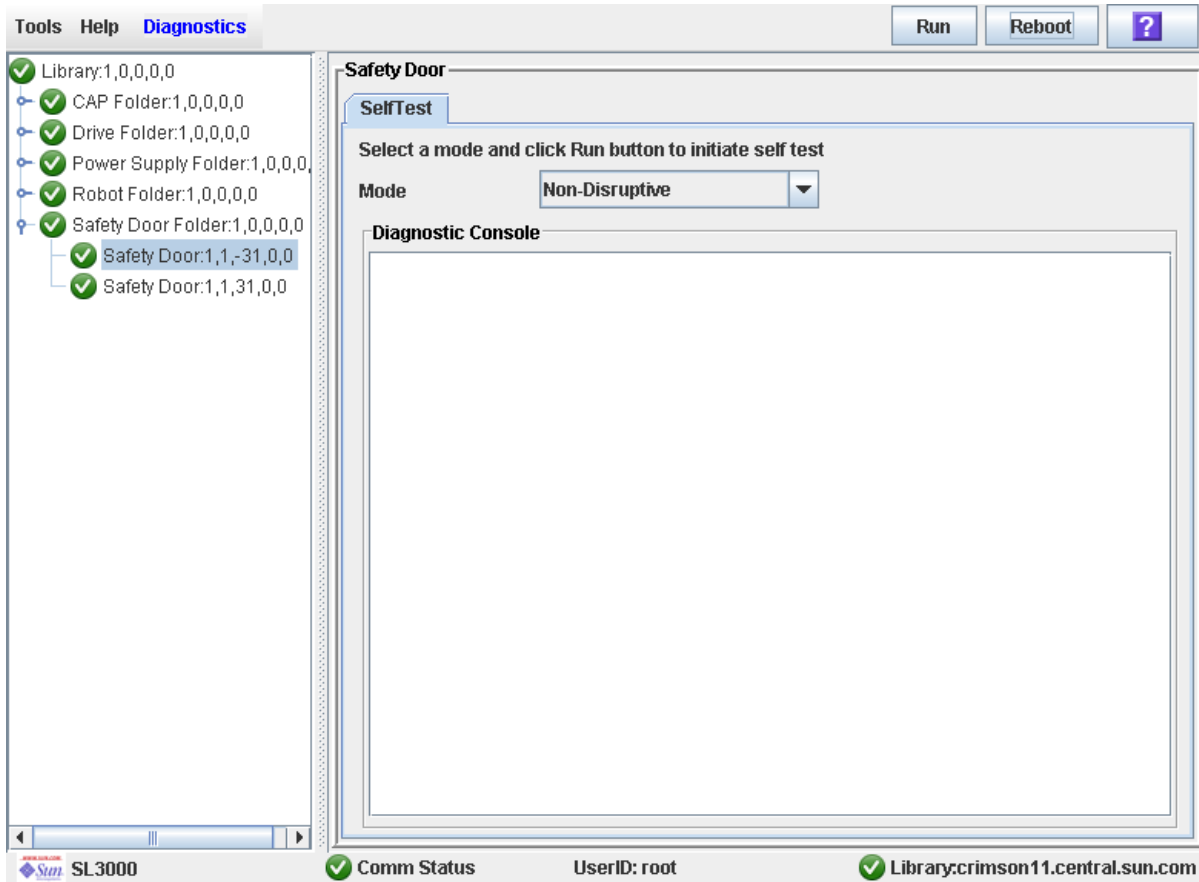

3. Click **Reboot** in the Options Bar.

If the safety door is online, the **Offline Confirm** popup appears.

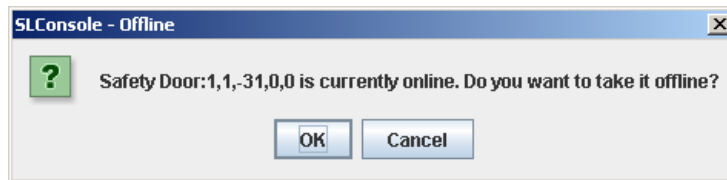

4. Click OK to vary the safety door offline.

The **Reboot Confirm** popup appears.

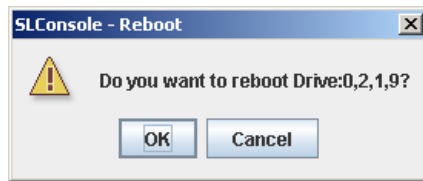

5. Click OK.

The library controller reboots the safety door. The safety door is re-initialized, and the TallBot audits the AEM CAP.

The **Reboot Success** popup appears.

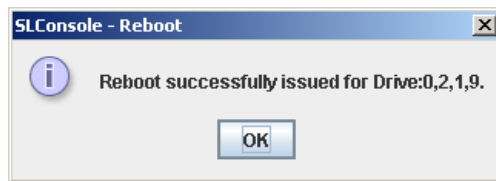

6. Click OK to dismiss the popup.



# Manual Operations

---

When in manual mode of operation, the library is unavailable for host access. This may be because the library has experienced an unrecoverable error or a library component requires service or installation. When the library is in this mode, cartridge mounts and dismounts require human intervention.

---

## Library Safety

Thoroughly review the safety precautions in this section before attempting to enter the library. It is essential that you follow proper safety procedures at all times.

### General Safety Precautions

---

**Warning – Possible Physical Injury.** To prevent accidental closure of the access door while someone is in the library, it is recommended that when you unlock the access door, you lock it open and retain the key on your person.

---

Before entering the library, be sure you:

- Know the location of the emergency door unlocking mechanisms. See [“SL3000 Door Interlocks”](#) on page 476.
- Leave the access door open whenever working inside the library. There is a switch on each door frame that disconnects DC power and signal lines to the library’s motors when an access door is opened. See [“SL3000 Servo Power Interrupt”](#) on page 476.
- Know the location of the mechanical door releases. See [“Mechanical Door Releases”](#) on page 477.
- Know the physical restrictions. See [“Physical Restrictions”](#) on page 477.

## SL3000 Door Interlocks

Door safety interlocks are located behind the front access doors of the Base Module and DEM. To open either access door, an access key is required.

Door safety interlocks are constantly monitored by the library controller. During normal operation, if an access door is opened an Emergency Robotics Stop condition is initiated and all library motors are immediately disabled. This prevents motors from operating while a library door is open. If the library is varied offline, opening the access door disconnects DC voltages to the rails and the power bus.

The door switches are also monitored when the library is powered off. A battery supplies power for the circuitry to detect a door opening/closing event while the library is powered off.

When a Base Module and DEM are connected together, opening an access door to either module automatically suspends operations within the entire library (the two door switches are connected in series).

## SL3000 Servo Power Interrupt

An additional safety feature is the servo power interrupt (SPI). If the library controller detects that a library motor is out-of-range, it will generate an SPI to turn off drive voltage to the faulty motor. This prevents a servo runaway condition until the cause of the problem can be determined.



## Mechanical Door Releases

Each lock handle on the access doors of the Base Module and DEM includes a mechanical release which is painted yellow (see [FIGURE 8-1](#).) This release serves as a safeguard in case a person is inside the library and the access door is accidentally closed and locked. When you push the release, it unlocks and opens the door.

FIGURE 8-1 Mechanical Door Release



## Interior Lighting

The interior of the library is always illuminated by white LEDs on the ceiling.

## Physical Restrictions

The library does not allow much free room for movement. You must be mindful of the restricted space at all times.

- Be careful not to snag your clothing on the plastic arrays that house the cartridges (only 0.4 m [18 in.] of aisle clearance).
- Be careful not to bump your head or body against the arrays.
- To gain access to a cartridge, you may have to move a TallBot, in which case you must avoid damaging the TallBot's electronic components.
- If you are loading or unloading a cartridge manually, your hands must remain clear of the drive's mechanical and electronic load components.

---

# Manual Operation Tasks

<b>Task</b>	<b>Page</b>
Vary the Library Offline	479
Vary the Library Online	479
Power Down the Library	479
Power Up the Library	479
Open the Library Main Access Door	479
Close and Lock the Library Main Access Door	487
Perform an AEM “Fast Access”	488
Close the AEM Access Door After a “Fast Access”	489

## ▼ Vary the Library Offline

Use this procedure to vary the library offline through the SL Console.

---

**Note** – You should use this procedure only if you are not using ACSLS or HSC tape management software, or if their servers are not able to communicate with the library. ACSLS and HSC are not notified when the state of the library or its components are changed through the SL Console, possibly leading to disruption in library operations. For instructions on changing the state of the library and its components through ACSLS or HSC, see the appropriate tape management software documentation.

---

You may need to use this procedure at the following times:

- Before powering down the library
- Before opening a library access door
- When the library is inoperative and requires maintenance

**1. Vary all library drives offline.**

See [“Vary a Drive Offline”](#) on page 452 for details.

**2. Select Tools > System Detail.**

**3. Click the Library folder on the device tree.**

4. Click the **Status** tab, and then the **General** tab.

The current status of the library is displayed.

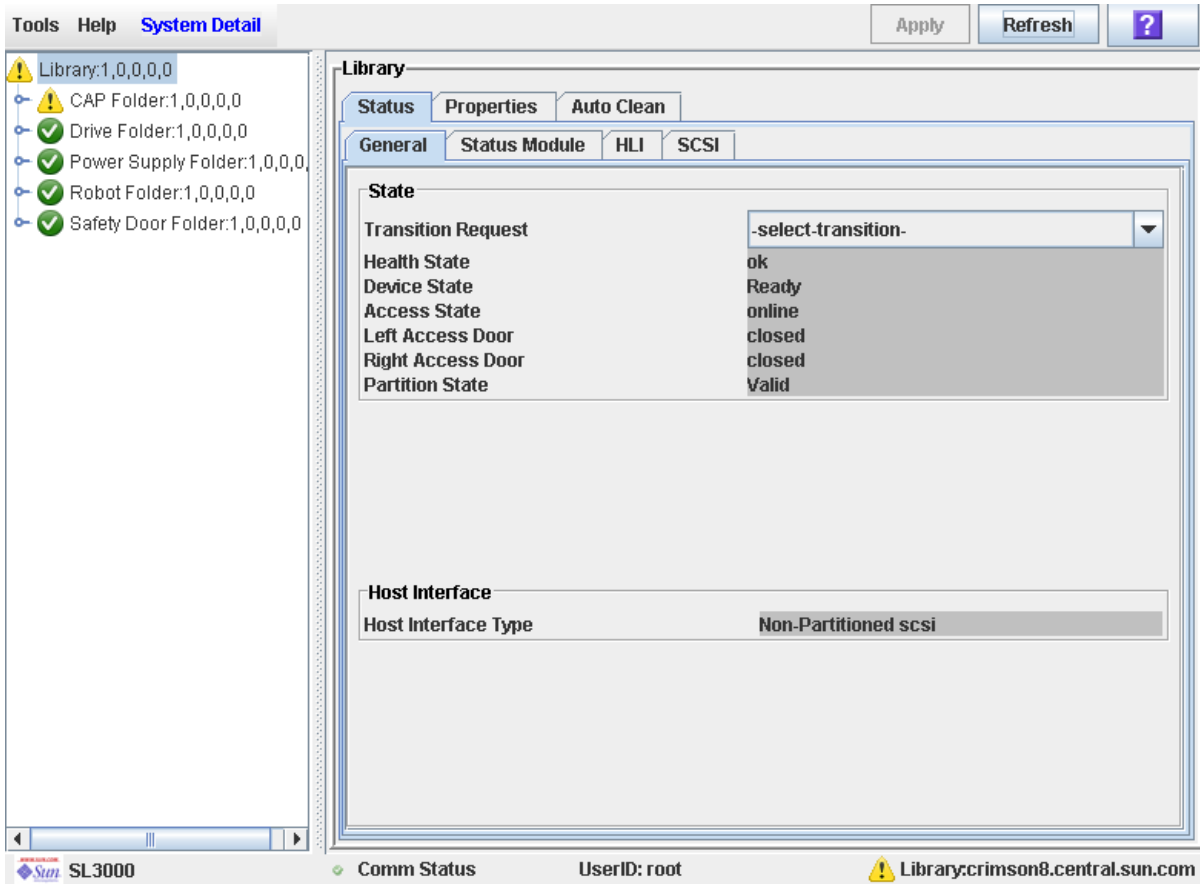

5. In the **Transition Request** field, click **Take offline**. Click **Apply**.

All outstanding library jobs are completed, and then the library status is changed, as follows:

- Health State: Warn
- Device State: Not accessible (HLI host connections); Not ready (SCSI host connections)
- Access State: Offline

## ▼ Vary the Library Online

Use this procedure to vary the library online through the SL Console.

---

**Note** – You should use this procedure only if you are not using ACSLS or HSC tape management software, or if their servers are not able to communicate with the library. ACSLS and HSC are not notified when the state of the library or its components are changed through the SL Console, possibly leading to disruption in library operations. For instructions on changing the state of the library and its components through ACSLS or HSC, see the appropriate tape management software documentation.

---



---

**Note** – LTO Ultrium drives are automatically brought online when you bring the library online.

---

1. Select **Tools > System Detail**.
2. Click the **Library** folder on the device tree.
3. Click the **Status** tab, and then the **General** tab.

The screen displays the current status of the library.

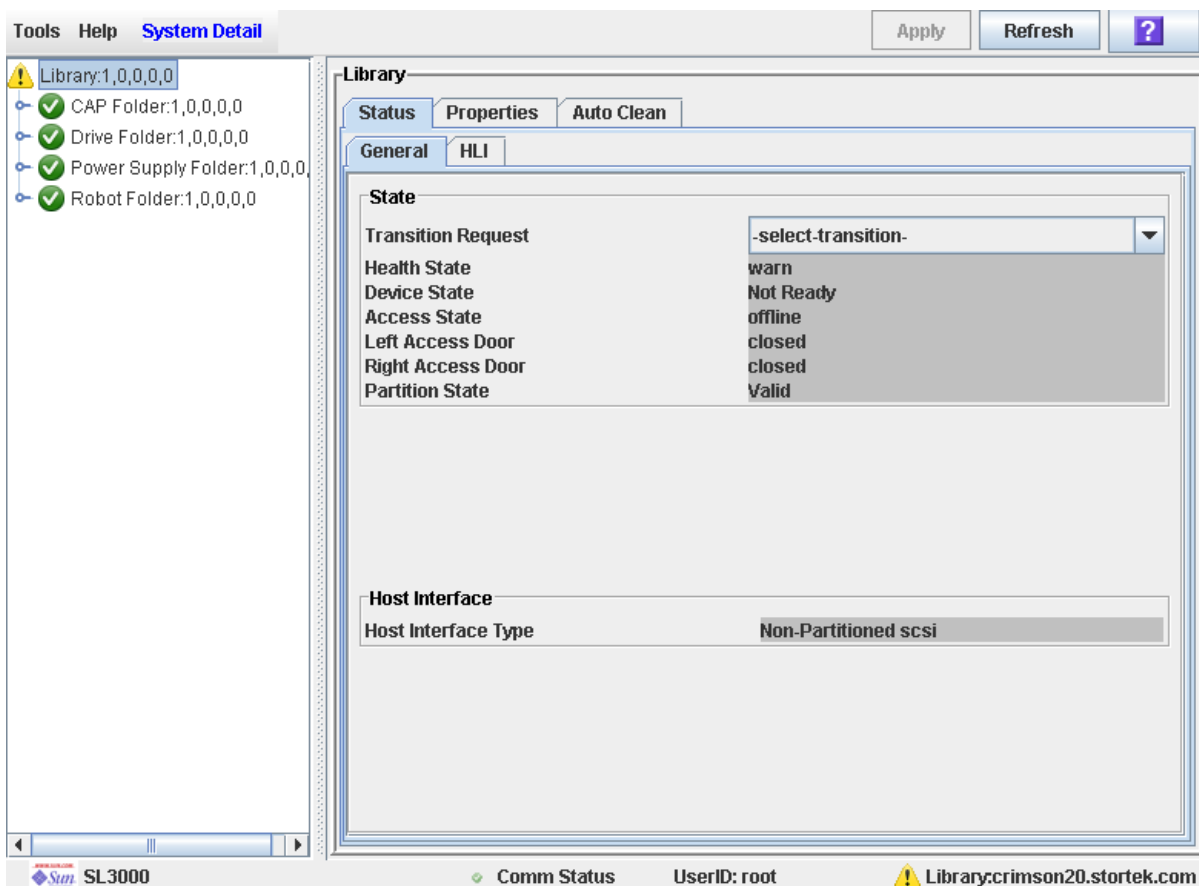

4. In the **Transition Request** field, click **Bring online**.

**5. Click Apply.**

The library status is updated, as follows:

- Health State: ok
- Device State: Ready
- Access State: Online

**6. If applicable, vary the library online to ACSLS and HSC hosts. See the ACSLS and HSC documentation for detailed procedures.**

## ▼ Power Down the Library

Use this procedure to power down the library.

**1. Vary all library drives offline.**

See [“Vary a Drive Offline” on page 452](#) for details.

**2. Vary the library offline.**

See [“Vary the Library Offline” on page 479](#) for details.

**3. Open the rear doors of the Base Module and DEM (if present).**

**4. Turn off the power enable switches.**

**5. If necessary, turn off the circuit breakers on the PDUs.**

## ▼ Power Up the Library

Use this procedure to power up the library. If the access doors have been opened and closed, a full audit of the library will be performed.

1. **Open the rear doors of the Base Module and DEM (if present).**
2. **If necessary, turn on the circuit breakers on the PDUs.**
3. **Turn on the power enable switches.**
4. **The library goes through the initialization sequence, as follows:**

The SL Console gets all library configuration data from the library controller. Therefore, you should be careful when logging in to the SL Console before the library has fully initialized. You may see warnings that configuration data is not yet available, in which case you need to exit and log in again at a later time. Additionally, if a library audit is performed as part of initialization, until the audit is complete, any configuration data displayed may not be completely up-to-date and accurate.

1. Library controller code is activated.
2. The library controller performs electronic discovery of library components:
  - a. Determines the AC power configuration (N+1 or 2N).
  - b. Verifies tape drive controller function.
  - c. Checks optional functions (for example, a local operator panel).
  - d. Establishes communication and configuration of the TallBot controller.
  - e. Polls all tape drives and determines their locations.
  - f. Queries all rotational and AEM CAPs:
    - If a CAP door is fully open, the door will be left open.
    - If the state of a CAP door is undetermined, it is updated to closed and locked.
3. The TallBot performs the physical discovery process:
  - a. The TallBot sweeps the entire library to determine the library size.
  - b. The TallBot scans the module identification block in each module.
  - c. Depending on this information, the library is auto configured.
4. If one of the access doors was opened and closed, a library audit will begin, as follows:
  - a. The TallBot targets on each column of arrays (from the top, down).
  - b. The TallBot scans up each column, recording the VOLIDs of all cartridges.
  - c. The location of each VOLID is recorded in the library controller database.
  - d. Storage cells without cartridges are flagged as empty.
  - e. If a cartridge is found in a rotational or AEM CAP, the CAP is closed and locked.



---

**Note** – This audit does not update the host cartridge databases. See the appropriate tape management software documentation for details about updating the host databases.

---

f. The library comes to a Ready state.

**5. Vary the library online.**

See [“Vary the Library Online” on page 481](#) for detailed instructions.

## ▼ Open the Library Main Access Door

Use this procedure to open the main doors of the library.

---

**Warning – Possible Physical Injury.** To prevent accidental closure of the access door while someone is in the library, it is recommended that when you unlock the access door, you lock it open and retain the key on your person.

---

1. **Vary all library drives offline.**  
See [“Vary a Drive Offline” on page 452](#) for details.
2. **Vary the library offline.**  
See [“Vary the Library Offline” on page 479](#) for details.
3. **Insert the key into the door lock, and turn the key to unlock the door.**
4. **Pull up on the door latch to release it, and open the door.**
5. **Turn the key in the lock, to lock the door open, and then remove the key from the lock and keep it with you. This will prevent the door from being closed while you are in the library.**
6. **Enter the library.**

## ▼ Close and Lock the Library Main Access Door

Use this procedure to close and lock the main doors of the library.

1. **Verify that there are no loose items in the library.**
2. **If the access doors were locked open, insert the key into the door lock, and turn the key, to unlock the door.**
3. **Push the door closed and make sure it latches securely.**
4. **Turn the key in the lock, to lock the door closed.**
5. **Remove the key from the lock and keep it in a safe place.**
6. **If the library has been powered down, power it up.**

See [“Power Up the Library” on page 484](#) for details.

---

**Note** – Because the access doors have been opened, the library will go through a full audit.

---

## ▼ Perform an AEM “Fast Access”

Use this procedure to gain emergency access to the AEM.

---

**Caution** – This procedure has the same effects on library operations as opening the main library access door. It causes an abrupt interruption of library activity and should be used only in exceptional circumstances, such as an AEM component failure. This procedure does not lower the internal AEM safety door.

---

---

**Note** – When the AEM access door is closed, a full audit of the library is initiated. See [“Close the AEM Access Door After a “Fast Access””](#) on page 489.

---

1. **Insert the library access door key in the Deadbolt Override lock, and unlock the door by turning the key clockwise.**

---

**Note** – The key cannot be removed from the lock while it is in the unlocked position.

---

2. **Lift the AEM access door latch, and open the door.**

---

**Caution** – *Possible Equipment Damage.* DO NOT force the AEM access door to open or close.

---

All power to the rails is killed, and the TallBots are stopped immediately.

All in-process jobs are stopped abruptly, and the TallBots and AEM CAPs are brought offline.

---

**Caution** – The AEM safety door is not lowered.

---

## ▼ Close the AEM Access Door After a “Fast Access”

Use this procedure to close the AEM access door and re-initialize the library after performing an AEM “fast access.”

---

**Note** – This procedure initiates a full audit of the library.

---

### 1. Close and latch the AEM access door.

---

**Caution** – *Possible Equipment Damage*. DO NOT force the AEM access door to open or close.

---

### 2. Lock the door by turning the key counter-clockwise in the Deadbolt Override lock.

- The library re-initializes.
- The TallBots go through their initialization sequence.
- A full audit of the library is conducted.
- The AEM CAP is brought online and returned to its default state.



## Library Resource Addresses

---

This appendix describes the following library addressing schemes:

- [Library Internal Address](#) – Used by the library controller.
- [HLI-PRC Locations](#) – Used by hosts with TCP/IP connections to the library.
- [FC-SCSI Element Locations](#) – Used by hosts with FC-SCSI connections to the library.
- [Drive Hardware Numbers](#) – Physical array slot into which a drive is installed.
- [Drive Dynamic World-Wide Names](#) – Automatically generated by the library controller for installed drives.

These schemes are used to locate all library resources, including:

- Cartridge storage cells
- Tape drive slots
- Installed drives
- System/reserved cells
- Rotational and AEM CAP cells

---

## CenterLine Technology

The SL3000 modular design uses CenterLine technology to help balance the work load and improve performance of the library. The left side of the Base Module – which is the only required module – serves as the centerline. You can add other modules to the left and right of the Base Module. Columns to the right of the centerline have positive (+) numbers, while columns to the left have negative (–) numbers.

FIGURE A-1 Centerline and Column Addressing

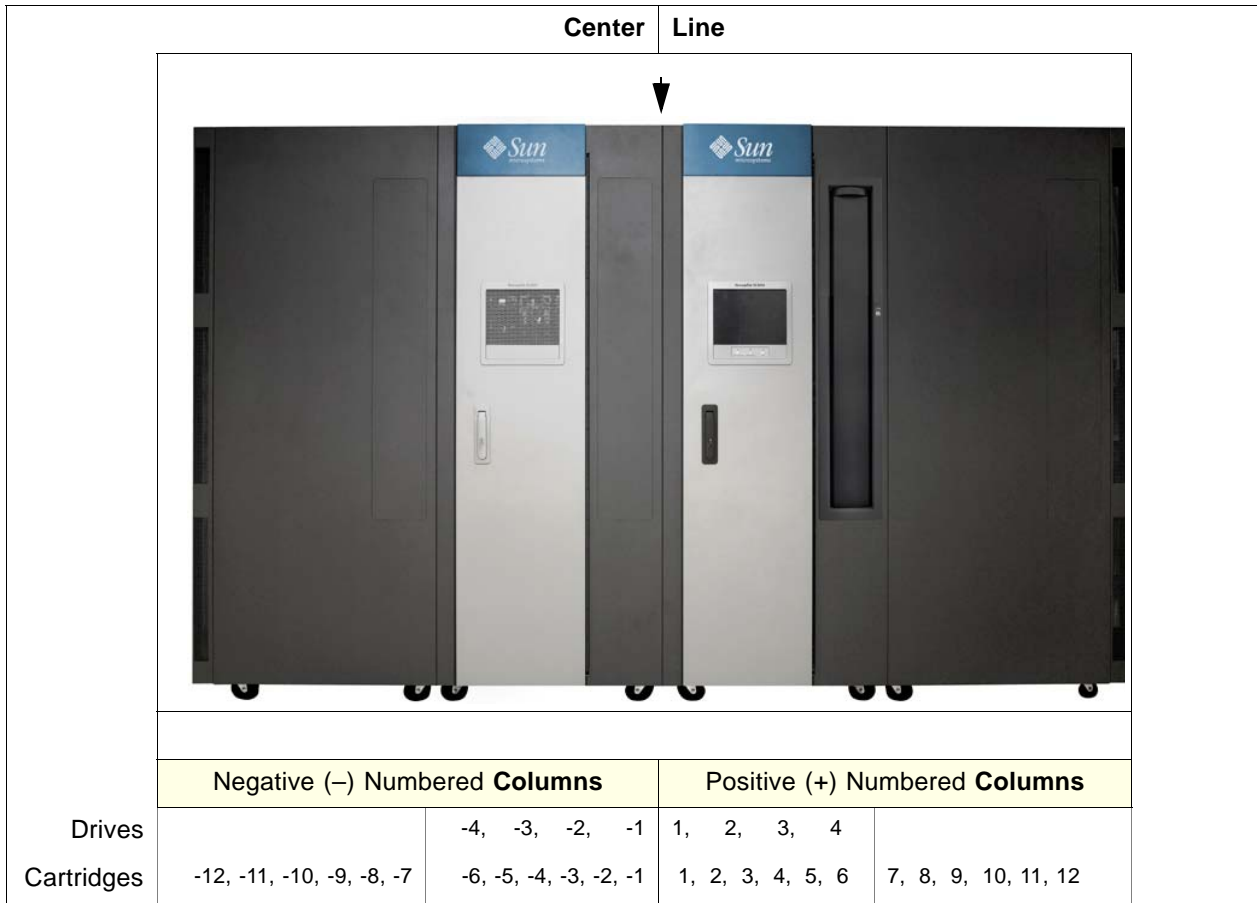



# Library Internal Address

## Storage Cells

There are five components to the SL3000 library internal addressing scheme:

1. **Library number:** always "1."
2. **Rail number:** always "1."
3. **Column number:** the horizontal location. Column numbering starts from the left edge of the back wall of the Base Module, as viewed from the front of the library. Columns to the right of this edge, whether within the Base Module itself or in modules connected to the right, are numbered positively (+), from left to right, starting with +1. Columns in modules connected to the left of the Base Module are numbered negatively (-), from right to left, starting with -1.
4. **Side:** the back wall = 1, the front wall = 2.
5. **Row:** the vertical position. Row numbering runs from top to bottom and can range from 1 to 52.

---

**Note** – For any library, the actual numbering of columns and rows depends on the modules installed and the configuration of drives vs. storage cells. See [TABLE A-1 on page 493](#) for details.

---

## Library Internal Address Example – Base Module

As an example of using the library internal addressing scheme, refer to [TABLE A-1 on page 493](#), drive hardware number 13 would be 1, 1, +4, 1, 4, as follows:

1. Library number = 1
2. Rail number = 1
3. Column number = +4
4. Side = 1
5. Row = 4

TABLE A-1 Base Module – Rear Wall Locations (viewed from the front of the library)

Row	+1		+2	+3		+4
+1	Drive 4		Drive 3	Drive 2		Drive 1

TABLE A-1 Base Module – Rear Wall Locations (viewed from the front of the library)

<b>Row</b>	<b>+1</b>		<b>+2</b>	<b>+3</b>		<b>+4</b>
+2	Drive 8		Drive 7	Drive 6		Drive 5
+3	Drive 12		Drive 11	Drive 10		Drive 9
+4	Drive 16		Drive 15	Drive 14		Drive 13
	+1	+2	+3	+4	+5	+6
+24 ~ +35	Storage cells	Storage cells	Storage cells	Storage cells	Storage cells	Storage cells
+36 ~ +48	Storage cells	Storage cells	Storage cells	Storage cells	Storage cells	Storage cells
+49 ~ +52	No array	Top two = Drop off  Bottom = Swap	4-cell Diagnostic/ Cleaning	4-cell ID	4-cell Diagnostic/ Cleaning	4-cell Diagnostic/ Cleaning
<b>Note:</b> Perspective is from the front of the library.						

As a second example, the location for the two drop-off cells on this wall are...

1. Library number = 1
2. Rail number = 1
3. Column number = +2
4. Side = 1
5. Rows = 49 and 50

...which translates to 1, 1, +2, 1, 49 and 1, 1, +2, 1, 50.

## Library Internal Address Example – DEM

See [TABLE A-2 on page 496](#) for drive hardware number 27. As an example of using the library internal addressing scheme, this drive location would be...

1. Library number = 1
2. Rail number = 1
3. Column number = -3
4. Side = 1
5. Row = 1

...which translates to 1, 1, -3, 1, 1.

As a second example, the location for the four-cell array that can contain diagnostic cartridges on this wall are...

1. Library number = 1
2. Rail number = 1
3. Column number = -4
4. Side = 1
5. Rows = 49 through 52

...which translates to 1, 1, -4, 1, 49 through 1, 1, -4, 1, 52.

TABLE A-2 Drive Expansion Module – Rear Wall Locations (viewed from the front of the library)

-4		-3	-2		-1	Row
Drive 28		Drive 27	Drive 26		Drive 25	1
Drive 32		Drive 31	Drive 30		Drive 29	2
-6	-5	-4	-3	-2	-1	
Storage cells	Storage cells	Storage cells	Storage cells	Storage cells	Storage cells	13 ~ 23
Storage cells	Storage cells	Storage cells	Storage cells	Storage cells	Storage cells	24 ~ 35
Storage cells	Storage cells	Storage cells	Storage cells	Storage cells	Storage cells	36 ~ 48
No array	Top 2 = Drop off Bottom = Swap	4-cell Diagnostic/ Cleaning	4-cell ID	4-cell Diagnostic/ Cleaning	4-cell Diagnostic/ Cleaning	49 ~ 52
<b>Note:</b> Perspective is from the front of the library.						

## System/Reserved Cells

A total of two cells are reserved within the Base Module only for drop-off locations and one cell is reserved as a swap cell. All remaining reserved cells can be used for diagnostic or cleaning cartridges; these are listed in [TABLE A-3 on page 497](#).

There are a total of 12 cells for diagnostic or cleaning cartridges in the Base Module; there are a total of 12 or 15 cells for diagnostic or cleaning cartridges in the DEM. These are also listed in [TABLE A-3 on page 497](#).

There are no reserved cells in a CEM or PEM.

TABLE A-3 Reserved Cells

Cell Locations	Module Type	Use	Location
1, 1, 2, 1, 49 – 50	Base module	Drop off cells (Reserved)	Back wall of the Base Module
1, 1, -4, 1, 49 – 50	DEM	Cleaning/Diagnostics Cartridges	Back wall of the DEM
1, 1, 2, 1, 51	Base module	Swap cell (Reserved)	Back wall of the Base Module
1, 1, -5, 1, 51	DEM	Cleaning/Diagnostics Cartridges	Back wall of the DEM
1, 1, 5, 1, 49 – 52 1, 1, 6, 1, 49 – 52	Base module	Cleaning/Diagnostics Cartridges	Back wall of the Base Module
1, 1, -1, 1, 49 – 52 1, 1, -2, 1, 49 – 52	DEM	Cleaning/Diagnostics Cartridges	Back wall of the DEM

**Note:** Do not place data cartridges in a reserved cell. These cells are masked from the customer's database (that is, an online TallBot will never go to these cells).

## CAP Cells

Cell locations within the CAPs follow a similar notation scheme as other locations within the library:

1. **Library number:** (always "1")
2. **Rail number:** (always "1")
3. **Column number:** the horizontal location. This is referenced from the left edge (as you face the inside front) of the Base Module. From this point, columns are numbered as positive (+), consecutively, from left-to-right, throughout all modules connected to the right side of the Base Module.  
Conversely, if a module is attached to the left of the Base Module, column locations are numbered as minus (-), consecutively, from right to left, throughout all modules.
4. **Side:** (always "2" [front wall]).
5. **Row:** the vertical position, as referenced from the top cell in the column. Cells are numbered from 1 – 13 for the top magazine and 14 – 26 for the lower magazine. Magazine handles are located at the tops of each CAP magazine.

---

**Note –** The magazine handle is not counted as a cell.

---

## Library Internal Address Examples – CAP Cells

The fourth CAP cell down in a Base Module would be...

1. Library number = 1

2. Rail number = 1
3. Column number = +5
4. Side = 2
5. Row = 4

...which translates to 1, 1, +5, 2, 4.

The sixth CAP cell down in a DEM would be...

1. Library number = 1
2. Rail number = 1
3. Column number = -2
4. Side = 2
5. Row = 6

...which translates to 1, 1, -2, 2, 6.

# HLI-PRC Locations

## Storage Cells

The host library interface-panel, row, column (HLI-PRC) location (address) is an eight-digit, comma-separated value (LL, PP, RR, CC) representing **L**SM, **P**anel, **R**ow, **C**olumn. This addressing scheme is used by HLI clients, including ACSLS and HSC, to represent cartridge storage cells accessible to those HLI clients.

---

**Note** – The SL3000 library internal address identifies the physical location of the cartridge in the library and the HLI-PRC refers to the address assigned by the host software.

---

The cell location appears in the following format:

L	L	P	P	R	R	C	C
---	---	---	---	---	---	---	---

where,

LL: LSM number (always “00”)

PP: Panel (relative to the Base Module – descending numbers on the left and ascending numbers to the right; even numbers = rear walls, odd numbers = front walls)

- Base Module = panels 12 & 13
- DEM added to the left = panels 10 & 11

---

**Note** – Exception: If a CEM is added to the left of a Base Module instead of a DEM, that module’s panel numbering will be 8 & 9 (see [“HLI-PRC Storage Cell Locations – Example Three” on page 501](#)). This allows for a DEM to be installed at a later date without the necessity of re-numbering the modules.

---

- module added to the right = panels 14 & 15

---

**Note** – RR: Row in the panel (a number from 0 – 51)

Note the difference here. Library internal address rows begin with “1” and HLI-PRC rows begin with “0.”

---

CC: Column in the row (numbered left to right, from the front of the module)

---

**Note** – CC: Columns in the panel (a number from 0 – 5.

Note the difference here. Library internal address columns begin with “1” and HLI-PRC rows begin with “0.”

---

## HLI-PRC Storage Cell Locations – Example One

For an example of how this numbering scheme is formulated, refer to [TABLE A-4](#).

TABLE A-4 Host Library Interface Cell Locations – Example One

Drive Expansion Module						Base Module					
<b>Rear Wall = Panel 10</b>						<b>Rear Wall = Panel 12</b>					
Cartridge Column Numbers →						Cartridge Column Numbers →					
0	1	2	3	4	5	0	1	2	3	4	5
0	1	2	3	4	5	0	1	2	3	4	5
Cartridge Column Numbers →						Cartridge Column Numbers →					
<b>Front Wall = Panel 11</b>						<b>Front Wall = Panel 13</b>					
<b>Note:</b> Perspective is from the front of the library.											

In example one, the library is composed of two modules. The cell location of a cartridge on the rear wall of the Base Module at Column 5, Row 24, would translate to the following:

LL = 00, PP = 12, RR = 24, CC = 05; or 00, 12, 24, 05

## HLI-PRC Storage Cell Locations – Example Two

Adding a module to the left of the library described in Example One illustrates the “left descending” numbering scheme. Refer to [TABLE A-5](#) to see how this works.

TABLE A-5 Host Library Interface Cell Locations – Example Two

Cartridge Expansion Module						Drive Expansion Module						Base Module					
<b>Rear Wall = Panel 8</b>						<b>Rear Wall = Panel 10</b>						<b>Rear Wall = Panel 12</b>					
Cartridge Column Numbers →						Cartridge Column Numbers →						Cartridge Column Numbers →					
0	1	2	3	4	5	0	1	2	3	4	5	0	1	2	3	4	5
0	1	2	3	4	5	0	1	2	3	4	5	0	1	2	3	4	5
Cartridge Column Numbers →						Cartridge Column Numbers →						Cartridge Column Numbers →					
<b>Front Wall = Panel 9</b>						<b>Front Wall = Panel 11</b>						<b>Front Wall = Panel 13</b>					
<b>Note:</b> Perspective is from the front of the library.																	

In this example, a CEM has been added to the left of the DEM. Its panels are now numbered 8 and 9. Add another module to the left of this library and its panels become 6 & 7.

Conversely, adding a module to the right of the Base Module would make that module’s panel numbers 14 & 15, and so forth.



### HLI-PRC Storage Cell Locations – Example Three

For an exception to continuous panel numbering, a third example is presented in [TABLE A-6](#). In this library, two CEMs have been added to the left of a Base Module. Notice that, without a DEM, panel numbering to the left of the Base Module is now 8 & 9, instead of 10 & 11.

This illustrates:

- The one exception to the consecutive panel numbering scheme
- That if a DEM is installed in the future, no panel numbering will change for the existing modules

TABLE A-6 Host Library Interface Cell Locations – Example Three

Cartridge Expansion Module	Cartridge Expansion Module	Base Module
<b>Rear Wall = Panel 6</b>	<b>Rear Wall = Panel 8</b>	<b>Rear Wall = Panel 12</b>
Cartridge Column Numbers →	Cartridge Column Numbers →	Cartridge Column Numbers →
0   1   2   3   4   5	0   1   2   3   4   5	0   1   2   3   4   5
0   1   2   3   4   5	0   1   2   3   4   5	0   1   2   3   4   5
Cartridge Column Numbers →	Cartridge Column Numbers →	Cartridge Column Numbers →
<b>Front Wall = Panel 7</b>	<b>Front Wall = Panel 9</b>	<b>Front Wall = Panel 13</b>
<b>Note:</b> Perspective is from the front of the library.		

---

**Note** – This numbering scheme benefits customers greatly since adding a module does not require any change to their existing panel configurations.

---

Although the host tape management software follows a five-digit numbering scheme like that in the SL3000 address, there are significant differences in cell designations, rotational and AEM CAP behavior, and other operational considerations as described below.

If you need to locate a cartridge’s HLI-PRC location, see [“Locate a Cartridge by VOLID” on page 157](#). This procedure displays the cartridge information in both library internal address and HLI-PRC address formats.

## Drive Slots

For the drives, HLI-PRC locations are different from the notation you will see with cartridge storage cells. [TABLE A-7](#) illustrates how this numbering scheme works, as viewed from the rear of the library.

TABLE A-7 Host Library Interface Tape Drive Locations

Base Module				Drive Expansion Module			
Rear Panel =12				Rear Panel = 10			
1 <sup>3</sup>	2 <sup>2</sup>	3 <sup>1</sup>	4 <sup>0</sup>	25 <sup>3</sup>	26 <sup>2</sup>	27 <sup>1</sup>	28 <sup>0</sup>
5 <sup>7</sup>	6 <sup>6</sup>	7 <sup>5</sup>	8 <sup>4</sup>	29 <sup>7</sup>	30 <sup>6</sup>	31 <sup>5</sup>	32 <sup>4</sup>
9 <sup>11</sup>	10 <sup>10</sup>	11 <sup>9</sup>	12 <sup>8</sup>	33 <sup>11</sup>	34 <sup>10</sup>	35 <sup>9</sup>	36 <sup>8</sup>
13 <sup>15</sup>	14 <sup>14</sup>	15 <sup>13</sup>	16 <sup>12</sup>	37 <sup>15</sup>	38 <sup>14</sup>	39 <sup>13</sup>	40 <sup>12</sup>
17 <sup>19</sup>	18 <sup>18</sup>	19 <sup>17</sup>	20 <sup>16</sup>	41 <sup>19</sup>	42 <sup>18</sup>	43 <sup>17</sup>	44 <sup>16</sup>
21 <sup>23</sup>	22 <sup>22</sup>	23 <sup>21</sup>	24 <sup>20</sup>	45 <sup>23</sup>	46 <sup>22</sup>	47 <sup>21</sup>	48 <sup>20</sup>
				49 <sup>27</sup>	50 <sup>26</sup>	51 <sup>25</sup>	52 <sup>24</sup>
				53 <sup>31</sup>	54 <sup>30</sup>	55 <sup>29</sup>	56 <sup>28</sup>

**Notes:** Perspective is from the rear of the library.  
 The superscript numbers (in bold) represent the HLI-PRC locations (which translate into the Row number).  
 The standard number notation represents the drive hardware number.

- The standard numbers correspond with the physical numbering of the drives.
- The superscript numbers (in bold) correspond with the HLI-PRC (Row) locations.
- HLI-PRC numbering is sequential from right-to-left – from 0 to 3 – for the first (top) row of the first module.
- HLI-PRC sequential numbering scheme restarts, right-to-left – from 0 to 3 – in the next module.
- The Column number is always 0.

### HLI-PRC Drive Locations – Example One

Drives use drive numbers in place of row and column locations. The drive number is assigned to the position taken by a cell's row, and the position taken by a cell's column is always "00". For example, tape drive hardware number 20 is equivalent to this HLI-PRC location:

Library = 00  
 Panel = 12  
 Drive = 16  
 Column = 00

## HLI-PRC Drive Locations – Example Two

As a second example, going from an HLI-PRC location to a hardware location, tape drive 00, 10, 25, 00 is equivalent to tape drive hardware number 51.

## CAP Cells

CAP HLI-PRC locations are different from the notation used for cartridge storage cells. CAPs use CAP numbers in place of panel numbers.

### Rotational CAPs

- Library = always 00
- CAPs = 01–10, as follows:
  - Left side CEMs = 01 – 04, from left to right
  - DEM = 05
  - Base Module = 06
  - Right side CEMs = 06 – 10, from left to right
- Rows = 00–25
- Column = always 00

### AEM CAPs

- Library = always 00
- AEM CAPs = 00 or 11, as follows:
  - Left side AEM = 00
  - Right side AEM = 11
- Rows = 00–38
- Columns = 00–05

---

## FC-SCSI Element Locations

Since the SL3000 also offers a Fibre Channel control (library) interface, you must be aware of the cartridge/CAP/drive numbering according to FC-SCSI elements.

[TABLE A-8 on page 505](#) represents FC-SCSI element locations for the back walls of a library that has:

- Four modules
- 166 licensed cartridge storage cells
- 36 tape drives

[TABLE A-9 on page 506](#) represents FC-SCSI elements for the front walls of the same library.

---

**Note** – Both tables below list the FC-SCSI elements for a native, non-partitioned library.

---

TABLE A-8 and TABLE A-9 are examples only, presented for you to note that FC-SCSI element numbering is:

- For storage elements – top-to-bottom, left-to-right, beginning at the back wall (as viewed from the front, numbered 2000) and continuing with the same scheme at the front walls (as viewed from the front of the library).
- For rotational CAP elements (import/export elements) – top-to-bottom, left-to-right, beginning with element number 10 at the left-most module’s CAP
- Tape drives (data transfer elements) – left-to-right, top-to-bottom, beginning at the center line of the Base Module (element 1000) and continuing at the DEM.

A vacant drive slot will not be included in the sequence.

TABLE A-8 FC-SCSI Element Locations – Back Walls (as viewed from the front))

Cartridge Expansion Module		Drive Expansion Module (Center Line)				Base Module (Center Line)				Cartridge Expansion Module	
		→				←					
2000	2010	1022	1023	1024	1025	1000	1001	1002	1003	2060	2070
2001	2011	1026	Empty	1027	1028	1004	1005	1006	1007	2061	2071
2002	2012	1029	1030	Empty	1031	1008	1009	1010	1011	2062	2072
2003	2013	1032	1033	1034	1035	1012	1013	1014	1015	2063	2073
2004	2014	2020	2026	2032	2038	1016	Empty	1017	1018	2064	2074
2005	2015	2021	2027	2033	2039	1019	1020	1021	Empty	2065	2075
2006	2016	2022	2028	2034	2040	2044	2048	2052	2056	2066	2076
2007	2017	2023	2029	2035	2041	2045	2049	2053	2057	2067	2077
2008	2018	2024	2030	2036	2042	2046	2050	2054	2058	2068	2078
2009	2019	2025	2031	2037	2043	2047	2051	2055	2059	2069	2079
<p><b>Notes:</b> Tape drives begin numbering from the center line (left wall of the Base Module). Empty tape drive slots are not counted.</p>											

TABLE A-9 represents FC-SCSI element locations for the front walls of the same library, viewed through the front.

TABLE A-9 FC-SCSI Element Locations – Front Walls (as viewed from the front)

Cartridge Expansion Module		Drive Expansion Module (Center Line)				Base Module (Center Line)				Cartridge Expansion Module	
		←				→					
2080	2090	2100	2107	(CAP) 10		2123	2130	(CAP) 36		2146	2156
2081	2091	2101	2108			2124	2131			2147	2157
2082	2092	2102	2109			2125	2132			2148	2158
2083	2093	2103	2110	~		2126	2133	~		2149	2159
2084	2094	2104	2111			2127	2134			2150	2160
2085	2095	Door Latch	2112			Door Latch	2135			2151	2161
2086	2096		2113	35			2136	51		2152	2162
2087	2097		2114	2117	2120		2137	2140	2143	2153	2163
2088	2098	2105	2115	2118	2121	2128	2138	2141	2144	2154	2164
2089	2099	2106	2116	2119	2122	2129	2139	2142	2155	2155	2165
<p><b>Notes:</b> Perspective is looking through the front of the library.                      Cartridge storage cell locations are consecutive, skipping locations for the door latches.                      CAP cells are unique and sequential, from the left-to-right, as viewed through the front of the library</p>											

## Drive Hardware Numbers

The hardware number of a drive is strictly internal to the library, defined by the electrical wiring to the drive slot. These numbers are printed on decals on the interior of the rear doors of the library modules.

[TABLE A-10](#) illustrates this numbering scheme for the Base Module, as viewed from the rear of the module. [TABLE A-11 on page 508](#) illustrates the numbering for the DEM.

TABLE A-10 Base Module Tape Drive Numbering – Hardware

<b>Array Number</b>	<b>Drive Trays</b>			
1	Drive 1	Drive 2	Drive 3	Drive 4
	Drive 5	Drive 6	Drive 7	Drive 8
<b>Array Number</b>	<b>Drive Trays</b>			
2	Drive 9	Drive 10	Drive 11	Drive 12
	Drive 13	Drive 14	Drive 15	Drive 16
<b>Array Number</b>	<b>Drive Trays</b>			
3	Drive 17	Drive 18	Drive 19	Drive 20
	Drive 21	Drive 22	Drive 23	Drive 24
<b>Note</b> – Numbers shown are referenced from the rear of the Base Module.				

TABLE A-11 Drive Expansion Module Tape Drive Numbering – Hardware

Array Number	Drive Trays			
1	Drive 25	Drive 26	Drive 27	Drive 28
	Drive 29	Drive 30	Drive 31	Drive 32
Array Number	Drive Trays			
2	Drive 33	Drive 34	Drive 35	Drive 36
	Drive 37	Drive 38	Drive 39	Drive 40
Array Number	Drive Trays			
3	Drive 41	Drive 42	Drive 43	Drive 44
	Drive 45	Drive 46	Drive 47	Drive 48
Array Number	Drive Trays			
4	Drive 49	Drive 50	Drive 51	Drive 52
	Drive 53	Drive 54	Drive 55	Drive 56

**Note** – Numbers shown are referenced from the rear of the DEM.

## Drive Dynamic World-Wide Names

Drive dynamic World-Wide Names (dWWN), or Fibre Channel addresses, are automatically generated by the library controller during library initialization. dWWNs are assigned to library drive slots rather than devices. If a drive is replaced, the new drive receives the same name as the one it replaced, thereby eliminating the need for system re-configuration. There are three World Wide Names reserved for each drive slot: Node, Port A, and Port B.

**Note** – The dWWN feature is usually enabled at installation time. The library and tape drives all must have firmware that supports the dynamic World Wide Naming feature. When dWWN is enabled, all drives must be at the proper firmware level. If a drive has down-level firmware, it remains in the “configuring” state and is unavailable for host use.



## Wall Diagrams

---

This appendix provides diagrams and tables detailing the following:

- “Base Module Walls” on page 510
- “Drive Expansion Module Walls” on page 511
- “Cartridge Expansion Module Walls” on page 512
- “Parking Expansion Module Walls” on page 513
- “Access Expansion Module Walls” on page 514
- “Configuration Block” on page 515
- “Row Numbering” on page 516
- “Reserved/System Cells” on page 517

FIGURE B-1 Base Module Walls

**Base Module**

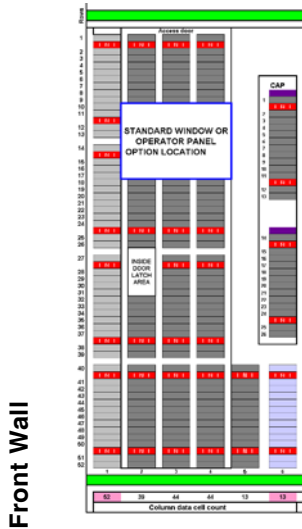

- 140 data cartridge cells
- With 26-cell rotational CAP
- With operator panel or window

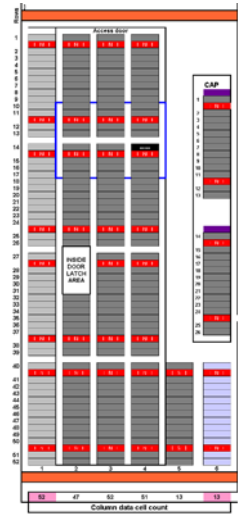

- 163 data cartridge cells
- With 26-cell rotational CAP
- With window cartridge array

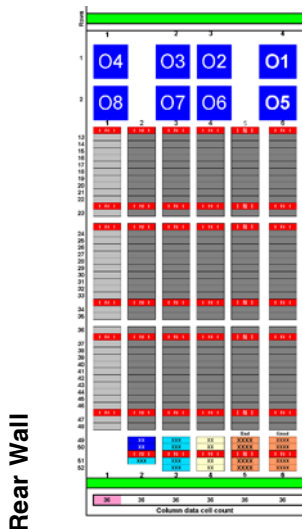

- 8 tape drive slots
- 180 data cartridges

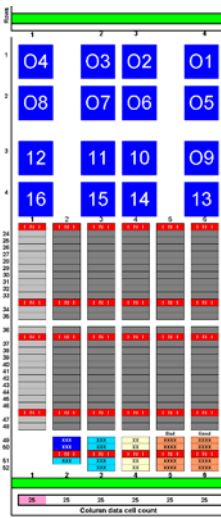

- 16 tape drive slots
- 125 data cartridges

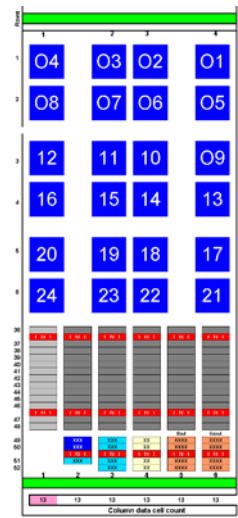

- 24 tape drive slots
- 65 data cartridges

**Note** – The light gray cells are not accessible unless an adjacent module is installed on that side.

FIGURE B-2 Drive Expansion Module Walls

**Drive Expansion Module**

**Front Wall**

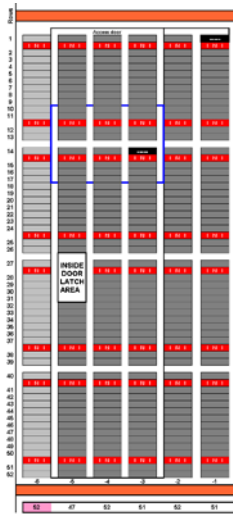

- 253 cartridge cells
- With window cartridge array
- No rotational CAP

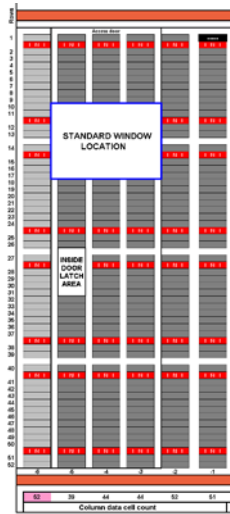

- 230 cartridge cells
- With operator panel or window
- No rotational CAP

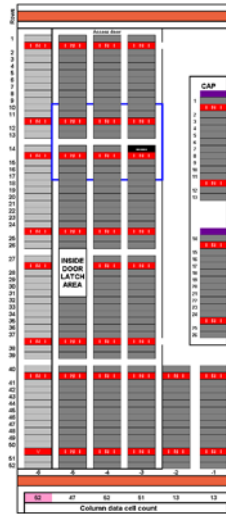

- 176 cartridge cells
- With 26-cell rotational CAP
- With window cartridge array

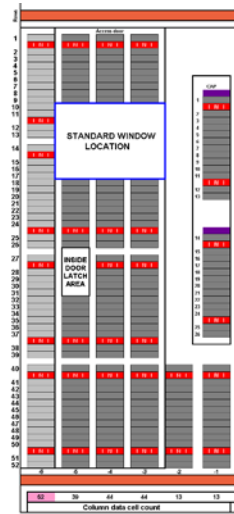

- 153 cartridge cells
- With 26-cell rotational CAP
- With operator panel or window

**Rear Wall**

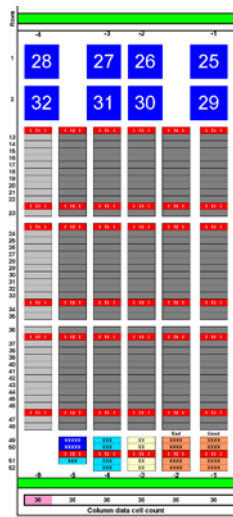

- 8 tape drive slots
- 180 data cartridges

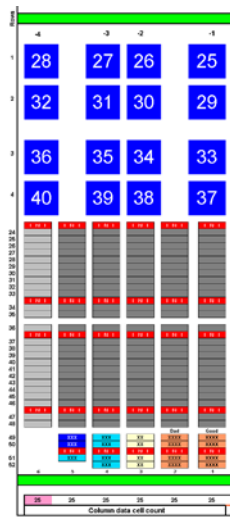

- 16 tape drive slots
- 125 data cartridges

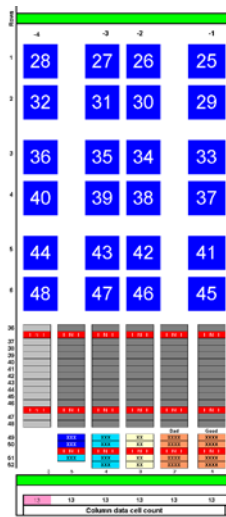

- 24 tape drive slots
- 65 data cartridges

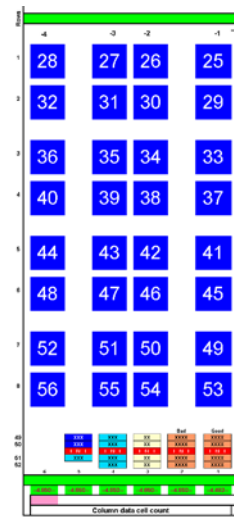

- 32 tape drive slots
- 0 data cartridges

**Note** – The light gray cells are not accessible unless an adjacent module is installed on that side.

FIGURE B-3 Cartridge Expansion Module Walls

**Left Cartridge Expansion Module**

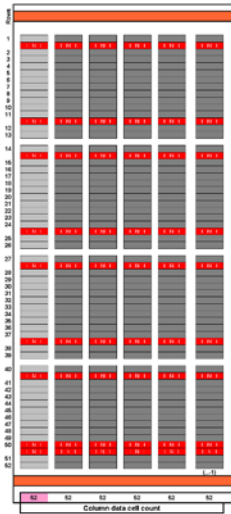

**Front Wall**  
 ■ 260 cartridge cells

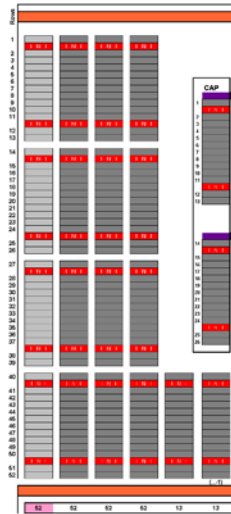

**Front Wall**  
 ■ 182 cartridge cells  
 ■ With 26-cell rot. CAP

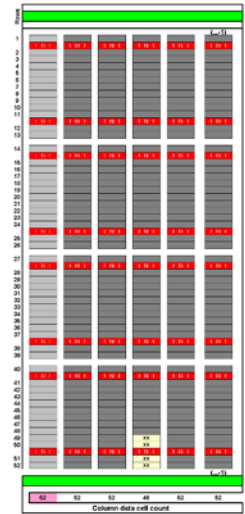

**Rear Wall**  
 ■ 256 cartridge cells

**Right Cartridge Expansion Module**

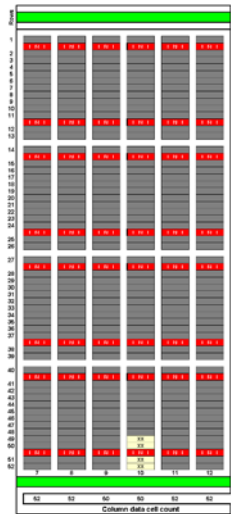

**Rear Wall**  
 ■ 308 cartridge cells

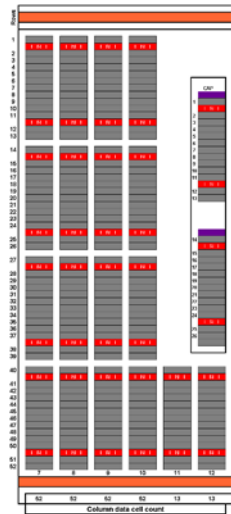

**Front Wall**  
 ■ 234 cartridge cells  
 ■ With 26-cell rot CAP

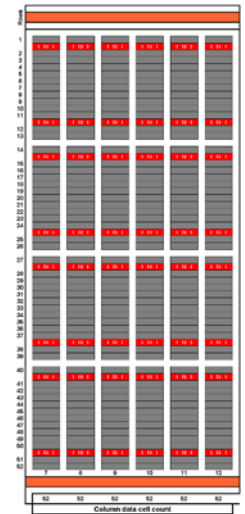

**Front Wall**  
 ■ 312 cartridge cells

**Note** – The light gray cells are not accessible unless an adjacent module is installed on that side.

FIGURE B-4 Parking Expansion Module Walls

**Left Parking Expansion Module**

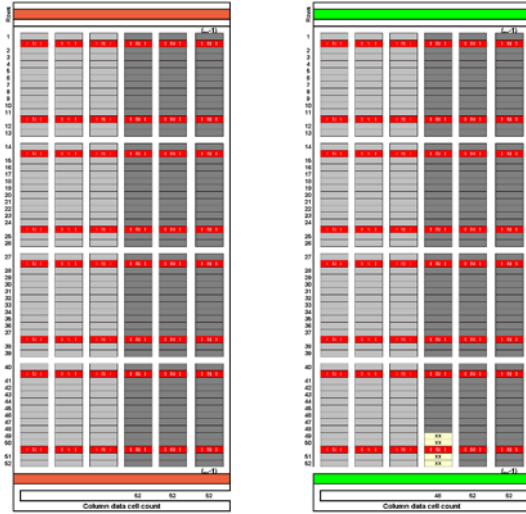

**Front Wall**  
 ■ 156 cartridge cells

**Rear Wall**  
 ■ 152 cartridge cells

**Right Parking Expansion Module**

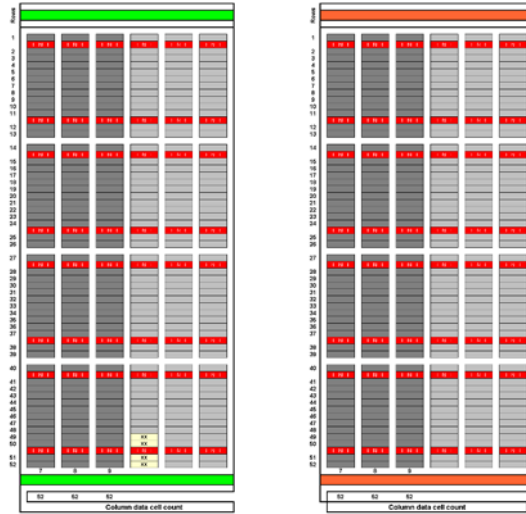

**Rear Wall**  
 ■ 156 cartridge cells

**Front Wall**  
 ■ 156 cartridge cells

**Note** – Six columns of arrays – three rear-wall and three front-wall – on both the left and right sides – are not accessible to allow for a defective robotics unit.

FIGURE B-5 Access Expansion Module Walls

**Left Access Expansion Module**

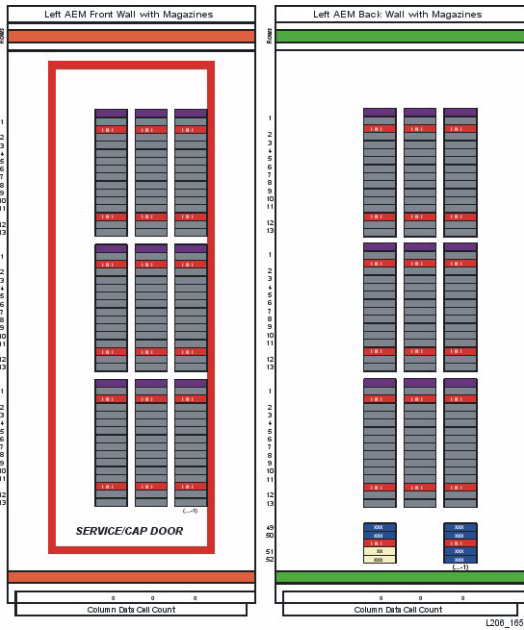

**Front Wall**  
 ■ 117 AEM CAP cells

**Rear Wall**  
 ■ 117 AEM CAP cells

**Right Access Expansion Module**

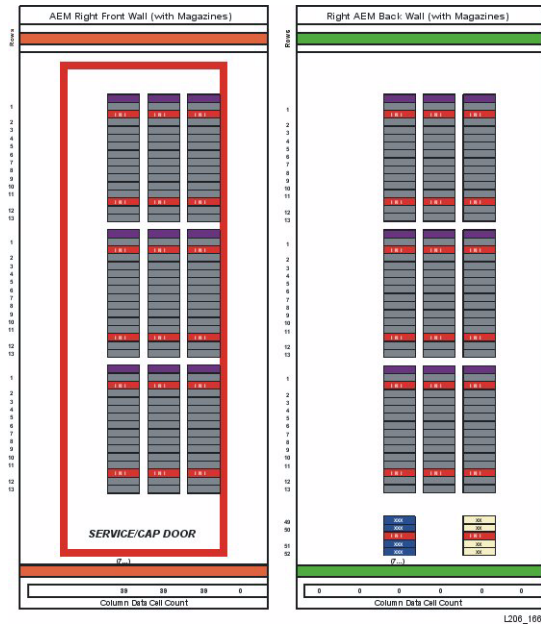

**Rear Wall**  
 ■ 117 AEM CAP cells

**Front Wall**  
 ■ 117 AEM CAP cells

# Configuration Block

Each module in the SL3000 library has a configuration block on the lower rear wall in column 4, rows 49, 50, 51, and 52. This block identifies the:

- Type of module
- Back wall configuration
- Front wall configuration
- Options for that module

During library initialization, the robotic assembly visits this configuration block to determine the configuration of the module.

FIGURE B-6 Configuration Block

**BASE DRIVE MODULE 01**

**BACK WALL : 1 DRV ARRAY = 8 DRIVES**

**FRONT WALL : CART ACCESS PORT**

**OPTION : OP PANEL OR WINDOW**

---

Module types:

■ Base Module	■ PEM
■ DEM	■ AEM
■ CEM	

---

Back wall configuration:

Target

---

Front wall configuration:

---

Options:

- Local operator panel
- Window
- Cartridge arrays

# Row Numbering

FIGURE B-7 Row Numbering

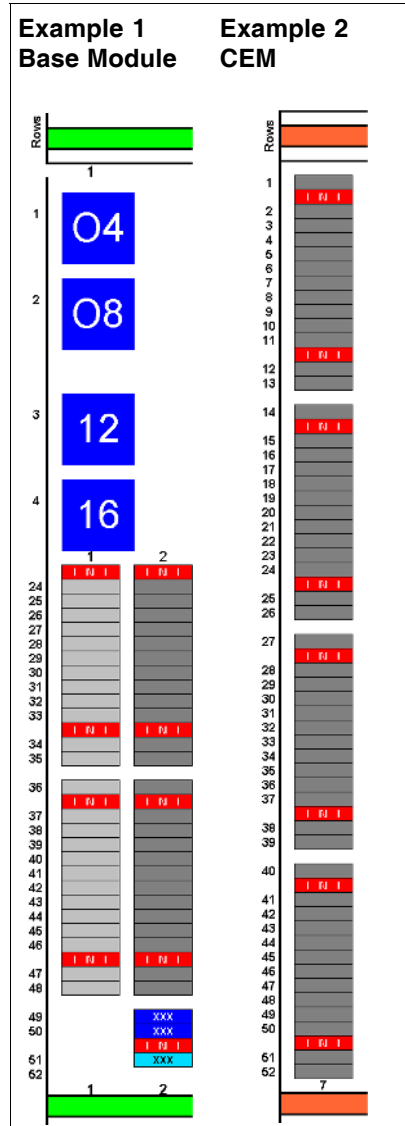

Rows indicate the vertical location of a cartridge or tape drive.

Rows are always positive numbers.

Storage cell rows are numbered from the top (1) to bottom (52).



## Reserved/System Cells

Both the Base Module and the Drive Expansion Module have special slots on the lower rear wall. These slots provide special functions for the library and tape drives.

FIGURE B-8 shows an example of these slots:

1. Swap slots (2) in column 2, rows 49 and 50.
2. Diagnostic slot (1) in column 2, row 51.
3. Diagnostic slot (4) in column 3, rows 49, 50, 51, and 52.
4. Configuration block in column 4, rows 49, 50, 51, and 52.
5. Cleaning cartridges (4) in column 5, rows 49, 50, 51, and 52.
6. Cleaning cartridges (4) in column 6, rows 49, 50, 51, and 52.

FIGURE B-8 Reserved Slots

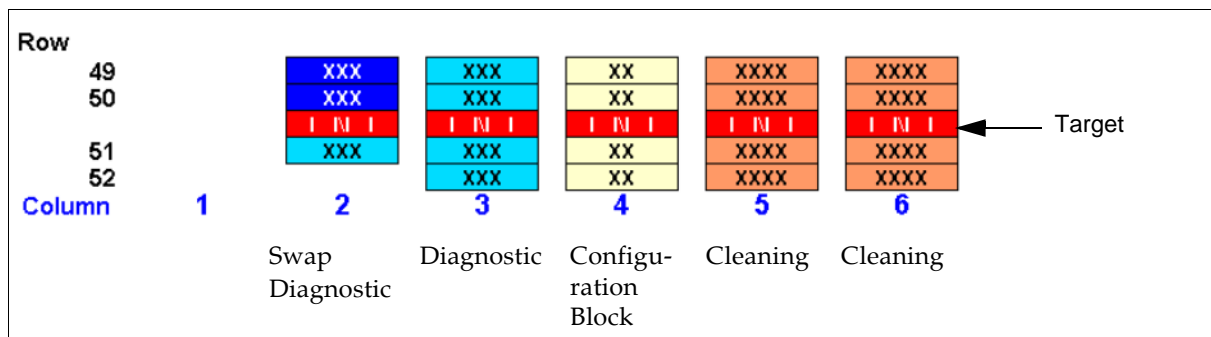



# Cartridge Handling

---

This appendix provides information on labeling and handling tape cartridges used in Sun StorageTek libraries.

---

## Cartridge Requirements

Library cartridges must meet specifications defined in *American National Standard Magnetic Tape and Cartridge for Information Interchange*. Refer to your drive vendor's publication and Web site for specific cartridge requirements and specifications.

Colored cartridges are approved only if the measured reflection density is greater than 0.1 as measured by an X-rite 404G color reflection densitometer. For more information about colored cartridges, contact your Sun StorageTek representative.

Colored measurements are:

Bandwidth	ANSI Status T Wide band (380 to 780 nm)
Measuring range	Density (0.00 to 2.50) D
Accuracy	±0.02 D
Repeatability	±0.01 D
Aperture diameter	3.4 mm (0.13in.)

For more information about colored cartridges, contact your Sun StorageTek representative.

---

## Valid Cartridge Labels

Library cartridges must be labeled with a valid external label. Several standard Code 39 bar code labels are supported by the library.

**Notes:**

- Unlabeled cartridges are not supported. See [“Unlabeled Cartridges” on page 523](#).

Pre-labeled cartridges are available from Sun StorageTek. For information on ordering these cartridges, see [“Ordering Cartridges and Labels” on page 525](#).

If you do not order pre-labeled cartridges, see [“Apply the Label on a Cartridge” on page 526](#) for detailed instructions on labeling the cartridges correctly. Sun StorageTek does not supply cartridge labels. For a supplier of labels only, see [“Ordering Cartridges and Labels” on page 525](#).

To display detailed cartridge information, see the following procedures:

- [“Display Library Cartridge Information in Tabular Format” on page 151](#)
- [“List Library Cartridges” on page 154](#)

## Media Domain and Media ID

The media domain and media ID together identify a cartridge’s media and usage to the library. They allow you to mix tape drive types and media types in a library. The media ID label corresponds to the tape drive or transport capable of using the cartridge. The media domain reflects the cartridge usage: data, cleaning, diagnostic.

## Cleaning and Diagnostic Cartridges

Cleaning cartridges have CLN in the VOLID; diagnostic cartridges have DG in the VOLID

Each cleaning and diagnostic kit includes one labeled cleaning cartridge and one labeled diagnostic cartridge, with a volume serial number of 0 (zero) for each. Extra cleaning and diagnostic labels are sent with each library.

Cleaning and diagnostic cartridges cannot be used as scratch cartridges or initialized by software utilities.

---

**Caution – PROCEDURE ERROR:** When you enter a cleaning cartridge, the software considers it to be new, and sets the usage counter to zero. **DO NOT RE-ENTER A CLEANING CARTRIDGE THAT LIBRARY EJECTS THROUGH THE CAP.**

---

## Cartridge Codes

The SL3000 library supports three types of barcode labels:

- For T9x40 drives, 1/2-inch labels supplied by Trioptic (Engineered Data Products/Colorflex) or Tricode (American Eagle/Writeline). Both versions require a separate Media ID Type, which is one character.
- For T10000 drives, labels with eight characters, the last two of which are the required Media ID Domain and the Media ID Type characters.
- For LTO® drives, labels with eight characters, the last two of which are the required Media ID Domain and the Media ID Type characters.
- For SDLT drives, labels with seven characters, the last of which is the required Media ID character.

## Sun StorageTek Tape Drives and Cartridges

Cartridge labels for Sun StorageTek T9840 (models C and D) and T10000 tape drives are listed in [TABLE C-1](#). These tape drives also support encryption.

TABLE C-1 Sun StorageTek Cartridge Codes

Media ID	Type of Cartridge
VOLID + R	T9840 data cartridge
VOLID + R (Green background)	T9840C VolSafe data cartridge
VOLID + R (Purple background)	T9840D VolSafe data cartridge
CLN (blank space) VOLID + U	T9840 cleaning cartridge
CLN (blank space) VOLID + Y	T9840D cleaning cartridge ( <b>Note:</b> The T9840D has a unique cleaning cartridge.)
DG (blank space) VOLID + R	T9840 diagnostic cartridge
VOLID + T1	T10000 data cartridge
DG (blank space) VOLID + T1	T10000 diagnostic cartridge
CLN (blank space) VOLID + CT	T10000 cleaning cartridge
VOLID + TS	T10000 (sport) data cartridge
DG (blank space) VOLID + TS	T10000 (sport) diagnostic cartridge
CLN (blank space) VOLID + CT	T10000 (sport) cleaning cartridge

## LTO Tape Drives and Cartridges

**Note** – LTO technology was initially developed by IBM, Hewlett-Packard, and Quantum. LTO is an “open format” technology, which means that users have multiple sources of product and media.

LTO cartridge labels have eight characters. The last two characters are the media ID (L3, L4, LT or LU). CLN or DG are the first characters on the cleaning or diagnostic labels. LTO 4 tape drives also support encryption.

TABLE C-2 LTO Cartridge Codes

Media ID	Type of Cartridge
L3	Generation 3 data cartridge
L4	Generation 4 data cartridge
LT	Write once read many times (WORM), 400 GB This feature prevents the user from altering or erasing information from the tape. For more information, go to your vendor Web site and do a search on WORM.

TABLE C-2 LTO Cartridge Codes (Continued)

Media ID	Type of Cartridge
LU	Write once read many times (WORM), 800 GB
CLN (blank space) + CU	Universal cleaning cartridge Sun recommends using the CLN + CU universal label instead of a vendor-unique label (CLN + C1 for Hewlett-Packard or CLN + C2 for IBM).
DG (blank space) + VOLID	Diagnostic cartridge (apply a DG label to a blank data cartridge to be used for library diagnostic tests)

## Handling Cartridges

Improper handling of cartridges can result in a loss of data or damage to a library component. To handle a cartridge correctly:

- Do not carry several cartridges loosely in a container. The leader blocks can snag on other cartridges and become unlatched.

---

**Note** – T9940 and LTO Ultrium cartridges have leader blocks. T9840 cartridges do not.

---

- Make sure that the leader block is latched every time you pick up a cartridge.
- Keep cartridges clean.
- Inspect a cartridge before each use and never put a damaged cartridge into a drive or library.
- Never release a leader block and pull tape from a cartridge.
- Never open a cartridge.
- Do not handle tape that is outside the cartridge; the tape edge might be damaged.
- Do not expose the tape or cartridge to direct sunlight or moisture.
- Do not expose a recorded cartridge to magnetic fields; this might destroy data on the tape.

## Inserting a Cartridge in a Drive or Cell

A defective or dirty cartridge can damage a drive. Always inspect a cartridge before you insert it into a drive or into a tape library. Look for:

- Cracked or broken cartridge
- Broken leader
- Broken tape access door
- Damaged file-protect selector or write-protect switch
- Liquid in the cartridge

- Labels not firmly attached or extending over the cartridge edge
- Any other obvious damage

A cartridge must be inserted in a storage cell, rotational or AEM CAP cell, or drive with the bar code on the bottom, and the VOLID readable from right to left. The cartridge hub must always be down.

---

## Unreadable Cartridges

Cartridges may be identified as unreadable for the following reasons:

- [Unlabeled Cartridges](#)
- [Upside-Down Cartridges](#)

HSC and ACSLS automatically eject unreadable cartridges from the library. FC-SCSI hosts may not; an unreadable cartridge may be moved automatically to a CAP during library initialization.

---

**Note** – If a large number of cartridges are reported as unreadable, you may suspect a faulty TallBot camera or scanner. This could result in a large number of cartridges mistakenly ejected from the library.

---

## Unlabeled Cartridges

Cartridges without external labels are not fully supported in the SL3000. Unlabeled cartridges will not be mounted on drives; however, they can be moved between CAPs and storage cells.

- If an unlabeled cartridge is placed in a CAP, the TallBot will leave the cartridge there. The cartridge's disposition depends on the host software.
- If an unlabeled cartridge is placed in a library storage cell, during an audit the cartridge will be reported as "unreadable, invalid media type." Depending on the host software, the cartridge may not be recognized by the host, or it may be ejected through the CAP.

## Upside-Down Cartridges

Insertion of upside-down cartridges should never be attempted, especially for Sun StorageTek cartridges. How the library handles this situation depends upon the cartridge type.

## Sun StorageTek Cartridges

---

**Caution** – Upside-down Sun StorageTek cartridges do not fit in library storage cells and may cause damage to the cartridge and the TallBot.

---

- If a Sun StorageTek cartridge is placed upside-down in a CAP magazine, the CAP will not be able to close.
- If a Sun StorageTek cartridge is placed upside-down in a library storage cell, the cartridge will extend from the storage cell and may damage the TallBot.

## LTO Cartridges

- If an LTO cartridge is placed upside-down in a CAP magazine, the TallBot will leave the cartridge there. The cartridge's disposition depends on the host software.
- If an LTO cartridge is placed upside-down in a library storage cell, during an audit the cartridge will be reported as "unreadable, invalid media type." Depending on the host software, the cartridge may not be recognized by the host, or it may be ejected through the CAP.

---

# Maintaining Cartridges

The following section describes general maintenance guidelines for cartridges.

## Cleaning the Cartridge Exterior

---

**Caution – CARTRIDGE DAMAGE:** Certain solvents can damage the cartridges. DO NOT USE ACETONE, TRICHLOROETHANE, TOLUENE, XYLENE, BENZENE, KETONE, METHYL ETHYL KETONE, METHYLENE CHLORIDE, ETHYLDICHLORIDE, ESTERS, ETHYL ACETATE, OR SIMILAR CHEMICALS TO REMOVE LABELS OR TO CLEAN CARTRIDGES.

---

Wipe all dust, dirt, and moisture from the cartridge with a lint-free cloth.

Use StorageTek Tape Cleaner Wipes, PN 4046289-01 to clean the cartridges. These wipes are saturated with isopropyl alcohol. Do not let any solution touch the tape or get inside the cartridge.

## Repairing a Detached Leader Block

When a T9940 or LTO Ultrium cartridge tape is damaged, use a backup tape if possible. If a cartridge leader block is detached, there is no backup tape, and the cartridge or tape has no obvious damage, you may repair the leader block using a repair kit provided by the tape supplier. You can use the tape one time to copy the data onto another tape.

## Storing Cartridges

Following are guidelines for cartridge storage:



- Do not take a cartridge out of its protective wrapping until you are ready to use it. Use the tear string, not a sharp instrument, to remove the wrapping.
- Store cartridges in a clean environment that duplicates the conditions of the room in which they are used.
- Before using a cartridge, make sure that it has been in its operating environment for at least 24 hours.
- Archival storage is 1 to 10 years for 9x40 cartridge tapes and 15 to 30 years for LTO Ultrium cartridge tapes.

---

## Ordering Cartridges and Labels

Contact your authorized Sun StorageTek Selling Agent for labeled cartridges.

For cartridge labels, contact EDP/Colorflex at:

- Phone: 1.888.438.8362 (domestic and international)
- Web site: <http://www.colorflex.com>

For technical questions, contact Sun StorageTek Sales Support at:

- Phone: 1.800.275.4785
- E-mail: [sales\\_support@storagetek.com](mailto:sales_support@storagetek.com)

## ▼ Apply the Label on a Cartridge

1. Make sure that the cartridge has been at room temperature for at least 24 hours.
2. Clean the surface where the label will be placed using a cleaning solution made for this purpose. See [“Cleaning the Cartridge Exterior” on page 524](#).
3. Peel the backing from the cartridge label.
4. Lay the cartridge flat, in the position you would use to insert the cartridge in a tape drive.
5. Position the cartridge label with the bar-code characters *below* the alphanumeric characters. Press it into place.

---

**Note** – On LTO Ultrium cartridge labels, the alphanumeric characters can be either vertical or horizontal.

---

6. If the cartridge has a customer label, place the label in the area and press it into place.
7. Repeat Steps 2 through 5 for the media ID label.
8. The label must be within the indented area of the cartridge so that the edges of the label are parallel to the edges of the cartridge. The label should be close to the inside edge of the indented area but must *never* overlap the edge of this area.

**Notes:**

- Make sure that the label is not placed elsewhere on the cartridge surface.
- Make sure that the edges of the label do not curl up; curling causes the cartridge to stick in the drive loader.
- Use labels that do not leave a residue when they are removed.
- Make sure that the label contains a VOLID.

# D

## Web-launched SL Console Server

---

The Web-launched SL Console is a standard feature of the SL3000 and is included on a CD shipped with each library. It enables the SL Console to be installed on a centralized Web server. Individual clients can then use a supported Web browser to download and log in to the Web-launched SL Console.

The Web-launched SL Console is deployed as a Java WebARchive (.war) file.

---

## Security Considerations

The customer is responsible for implementing all appropriate security systems, including firewalls, user access, etc.

---

## Server Requirements

You can deploy the Web-launched SL Console on any Web server that is compliant with the J2EE (Java 2 Platform, Enterprise Edition) platform. It is recommended that you use the Java System Web Server.

---

**Note** – All procedures in this document assume you are using the Java System Web Server.

---

# Server Installation and Management

Installation and management of the Web-launched SL Console server involves the following procedures:

- “Download the Java System Web Server” on page 528
- “Install the Sun Java System Web Server” on page 532
- “Log in to the Java System Web Server Administration Console” on page 536
- “Install and Deploy the Web-launched SL Console” on page 539
- “Start the Web-launched SL Console” on page 545
- “Update the Web-launched SL Console” on page 547

## ▼ Download the Java System Web Server

Use this procedure to download the Java System Web Server, if it is not already installed on your server.

---

**Note** – This procedure requires you to have a Sun Online Account username and password.

---

1. Open a Web browser, and in the Location Bar or Address field enter the URL of the Sun Web Servers page:

<http://www.sun.com/download/index.jsp?cat=Web%20%26%20Proxy%20Servers&tab=3&subcat=Web%20Servers>

2. On the Web Servers page, click the Web Server link that corresponds to your server platform.

	native NSAPI library form as well as the popular FastCGI form. An installer is provided to ease installation and <b>setup</b> .	
» <a href="#">Web Server 7.0 Update 1</a>	This is a full multi-language product installation with performance and stability improvements; out-of-box Java support for Servlets 2.5, JSP 2.1, JSF 1.2, and more; support for Java SE 5.0 and 6, plus NetBeans IDE 5.0, 5.5, and 5.5.1; and administration interface support for FastCGI.	<a href="#">Download</a>
» <a href="#">Web Server FastCGI Add-On 6.1 Service Pack 4</a>	This software provides support for the FastCGI protocol. This allows third-party applications that do not support the Web Server's native API (NSAPI) or may have thread safety issues to be safely used without a significant	<a href="#">Download</a>

3. On the Sun Java System Web Server screen (this will vary according to your selection in the previous step), scroll down to verify the list of supported platforms, and click Download.

Sun Java(TM) System Web Server 7.0 Update 1 is a full multi-language product installation. For platform and patch requirements, features, localizations, and other important information please read the [Release Notes](#).

New in Java System Web Server 7.0 Update 1:

- Performance and stability improvements
- Out-of-box Java support for Servlets 2.5, JSP 2.1, JSF 1.2, and more
- Support for Java SE 5.0 and 6
- Support for NetBeans IDE 5.0, 5.5, and 5.5.1
- Administration interface support for FastCGI
- More

Java System Web Server 7.0 introduced:

- Solaris AMD-64 and SPARC 64-bit platform support
- Redesigned administration framework featuring
  - Cluster management
  - Easy access to frequently utilized activities
  - Wizards to assist with difficult tasks
  - Full featured and scriptable Command Line Interface
  - Simplified management of SSL certificates
  - Fully localized browser based Graphical Interface

Language	Platform
Multi-language	Red Hat Enterprise Linux 4
Multi-language	Windows Server 2003, Enterprise Edition
Multi-language	Solaris 9/10, x86
Multi-language	Windows XP Professional
Multi-language	Red Hat Enterprise Linux 3 U4
Multi-language	SUSE Linux Enterprise Server 9 (x86)
Multi-language	HP-UX 11i
Multi-language	Solaris 8/9/10, SPARC
Multi-language	Windows 2000 Advanced Server SP4
Multi-language	Solaris 10 OS, AMD x64

**Price:** Free    **Download**

Did you find what you were looking for today?

4. In the Sun Download Center Login screen, enter your Username and Password, and click Login.

---

**Note** – If you do not already have an account, click **Register Now** and follow the instructions to create one.

---

The screenshot shows the Sun Downloads website interface. At the top, there is a blue header with the Sun Microsystems logo and the text "Sun Downloads". To the right of the header is a search bar with the word "Search" and a magnifying glass icon. Below the header, there is a breadcrumb trail: "Home > Download Center >".

The main content area is divided into two columns. On the left, there is a "Login" section with a green background. It contains two input fields for "Username" and "Password", a "Login >>" button, and three links: "» Forgot Username or Password?", "» Register Now", and "» Why Register?".

On the right, there is a "Your Selection:" section with an orange arrow pointing down. Below the arrow, the text reads: "Sun Java System Web Server 7.0 Update 1, Multi-Platform, English, Download".

Below the selection, there is a paragraph of text: "To continue, please log in with your Sun Online Account (Download Center, MySun, SunSolve, etc.). If you don't have an account, please [Register](#)."

At the bottom left, there is a "Download Center" section with three links: "» FAQ", "» Purchase & Shipping Policies", and "» Why Register?".

At the bottom of the page, there is a footer with the following text: "Contact | About Sun | News | Employment | Privacy | Terms of Use | Trademarks | Copyright 1994-2007 Sun Microsystems, Inc."

**5. In the Sun Download Center screen, make the following selections:**

- Click the **Accept License Agreement** radio button.

- Click the **Sun Java System Web Server** link that corresponds to your server platform.

**Sun Downloads**

Home > Download Center >

### Download

**Download Center**

- > FAQ
- > Purchase & Shipping Policies
- > Update Account
- > Log Out

**Sun Java System Web Server 7.0 Update 1**  
 Sun Java System Web Server 7.0 Update 1 is a secure, massively scalable and stable platform for the most demanding web sites. It features out-of-box support for Java technologies, SSL, clusters, an integrated search engine, and much more.

NOTE: This page offers files for different platforms - please be sure to download the proper file(s) for your platform. We highly recommend using [Sun Download Manager \(SDM\)](#), as it lets you pause, resume, and restart your download while ensuring a successful download experience. Just select the files you want to download, then click the "Download Selected with Sun Download Manager" button to automatically install and start SDM. Alternately, click directly on the links in the file list to download through your browser.

For any download problems or questions, please see the [Download Center FAQ](#).  
 How long will the download take?

**Download selected with Sun Download Manager** Easily manage your downloads (pause, resume, restart, verify). [» Learn more](#)

Solaris 10 OS, AMD x64/Solaris 9/9/10, SPARC/Solaris 9/10, x86 Platform - Sun Java System Web Server 7.0 Update 1			
<input checked="" type="checkbox"/>			
<input type="checkbox"/>		<a href="#">Sun Java Web Server 7.0 Update 1 - Sparc, Multi-language</a>	sjsws-7_0u1-solaris-sparc.tar.gz 144.09 MB
<input type="checkbox"/>		<a href="#">Sun Java Web Server 7.0 Update 1 - AMD x64/x86, Multi-language</a>	sjsws-7_0u1-solaris-amd64.tar.gz 130.84 MB

Red Hat Enterprise Linux 3 U4/Red Hat Enterprise Linux 4/SUSE Linux Enterprise Server 9 (x86) Platform - Sun Java System Web Server 7.0 Update 1			
<input checked="" type="checkbox"/>			
<input type="checkbox"/>		<a href="#">Sun Java System Web Server 7.0 Update 1 - Linux, Multi-language</a>	sjsws-7_0u1-linux-i586.tar.gz 113.50 MB

6. In the popup, click **Save to Disk**, to save the compressed archive file to a directory of your choice, and click **OK**.

**Note** – This process may take several minutes.

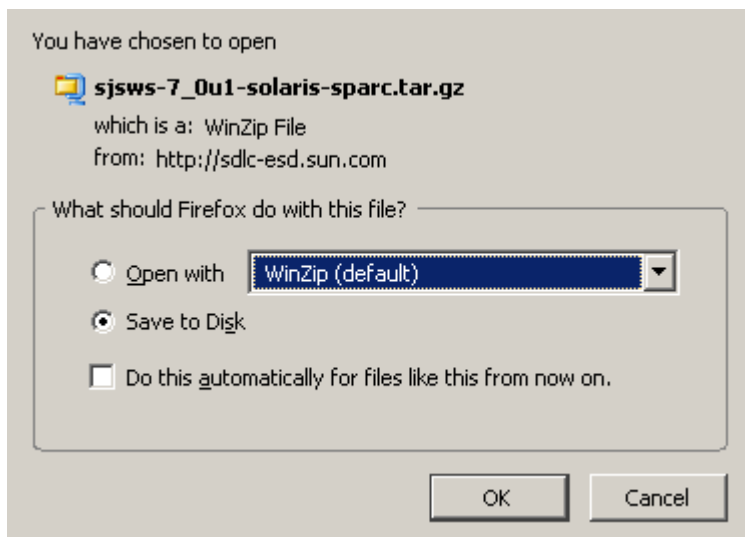

7. Use the appropriate extraction utility (for example, `gunzip`, `pkunzip`) to extract the Sun Java System Web Server files to a directory of your choice.

## ▼ Install the Sun Java System Web Server

Use this procedure to install the Java System Web Server, if it is not already installed on your server.

1. **In the directory where you have extracted the Sun Java System Web Server files, double-click or execute from a command line the setup file (setup or setup.exe, depending on your platform).**

If you are installing on a Solaris platform, you may need to invoke `root` or `sudo` permissions, depending on the directory you are installing to. If so, use the following steps:

- a. `cd extraction_directory`  
where *extraction\_directory* is the directory to which you extracted the compressed Java Web Server files.
- b. `xhost +`
- c. `sudo ./setup`

2. **On the Welcome screen, click Next.**





3. On the Software License Agreement screen, click the Yes radio button, and click Next.

**Software License Agreement**

Sun Microsystems, Inc. ("Sun") SOFTWARE LICENSE AGREEMENT ("SLA") and ENTITLEMENT for SOFTWARE

A. ENTITLEMENT for SOFTWARE. Capitalized terms not defined in this Entitlement have the meanings ascribed to them in the SLA (attached below as Section B). These terms will supersede any inconsistent or conflicting terms in the SLA.

Licensee ("You"): The entity receiving the Software from Sun.

Effective Date: Date You receive the Software.

Software: Solaris Enterprise System, which may include the following:

Do you agree with the terms of this license?

Yes

No

◀ Back    Next ▶    Cancel    Help

4. On the Select Installation Directory screen, specify the directory where you want the Web Server installed, and click Next.

**Select Installation Directory**

Installation Directory:

C:\Program Files\Sun\WebServer7    Browse...

◀ Back    Next ▶    Cancel    Help

5. On the Type of Installation screen, click Express, and click Next.

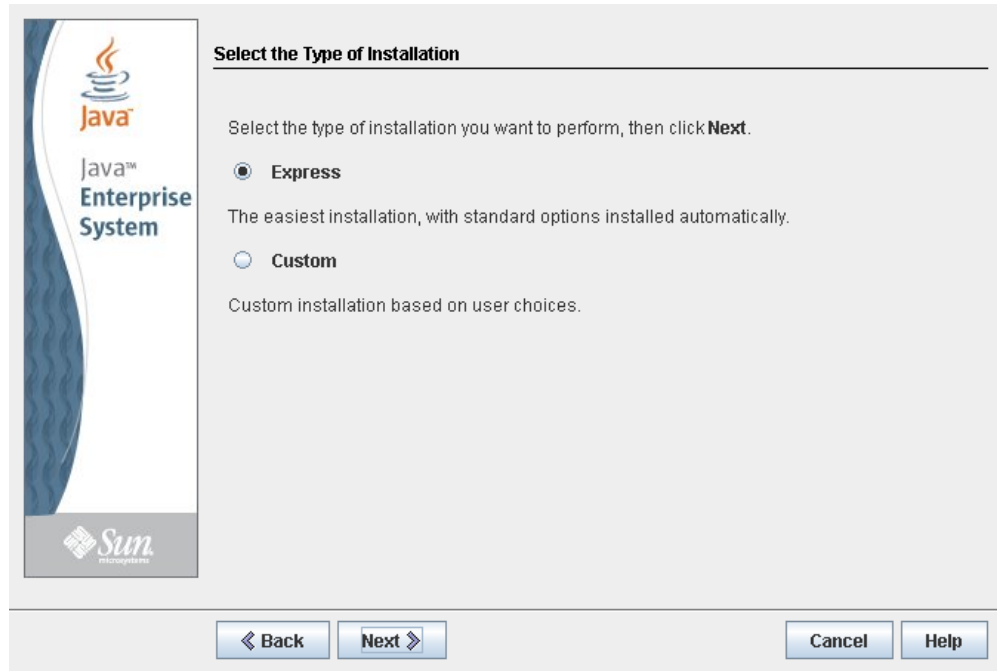

6. On the Administration Server Settings screen, specify a secure password for the admin user, and click Next.

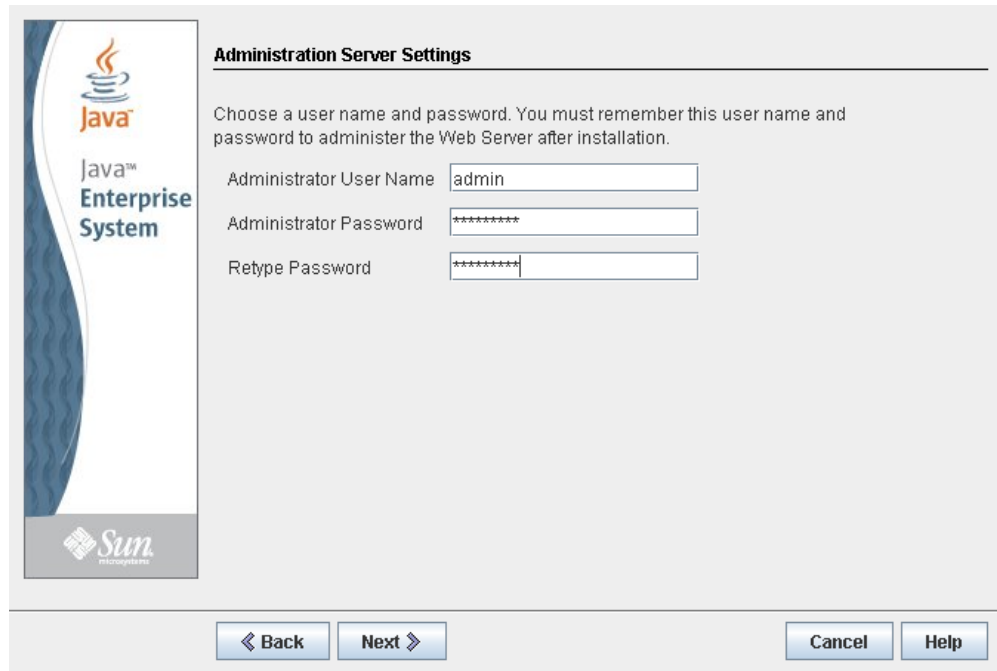

7. On the Ready to Install screen, review the installation information and click Install Now.

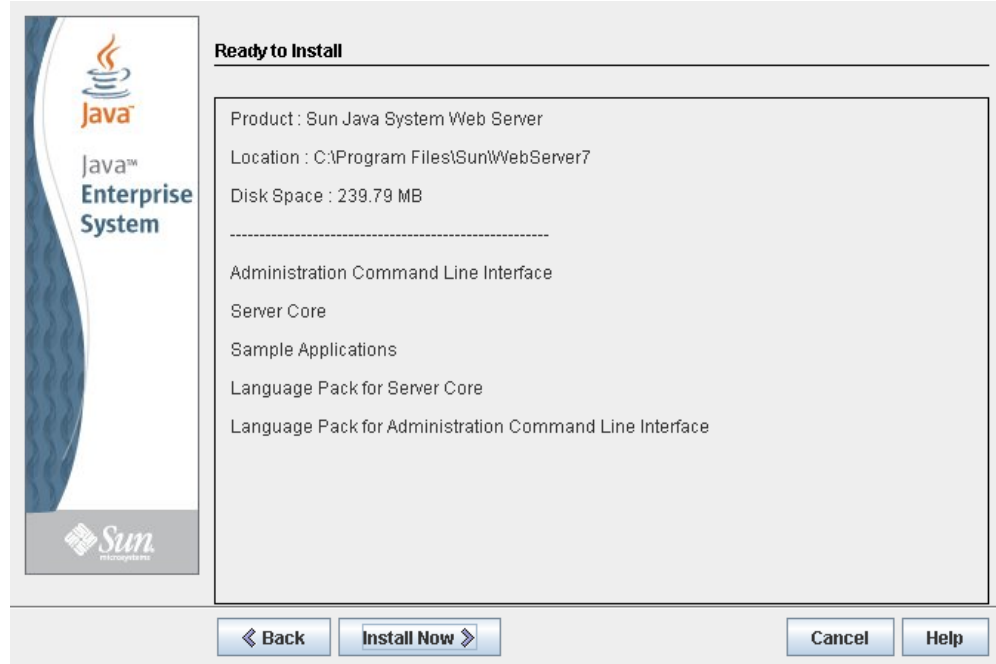

The installation begins, and screen with a progress bar is displayed.

8. On the Installation Complete screen, review the information and write down the Administration Console URL specified in #2 under "Next Steps. You will need this in the next procedure.

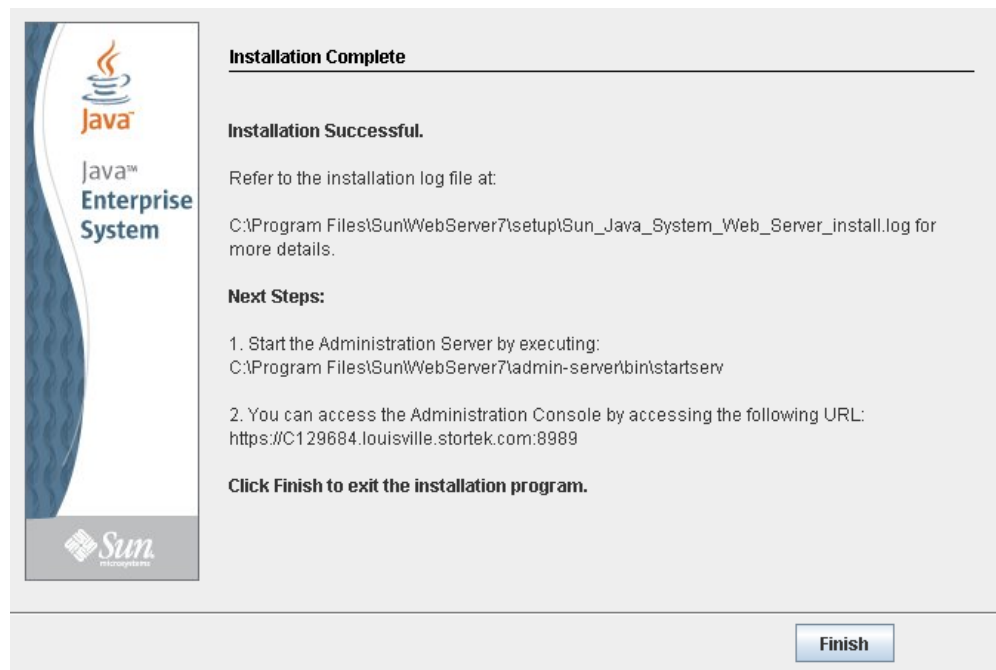

9. Click Finish to exit the setup program.

## ▼ Log in to the Java System Web Server Administration Console

1. **Start the Sun Java System Web Server, if it is not already running:**
  - On Windows – Click **Start > All Programs > Sun Microsystems > Web Server 7.0 > Start Administration Server**.
  - On Solaris – Open a terminal window, and type the following:

```
sudo /opt/webserver7/admin-server/bin/startserv
```

---

**Note** – Wait several minutes for the server to start.

---

2. **Open a Web browser, and in the Location Bar or Address field enter the URL you wrote down at the end of the previous procedure (“[Install the Sun Java System Web Server](#)”). This will start the Admin Console.**
3. **In the popup, accept the server certificate, and click OK.**



4. In the Web browser where you opened the Admin Console URL, enter the admin User Name and Password, and click Log in.

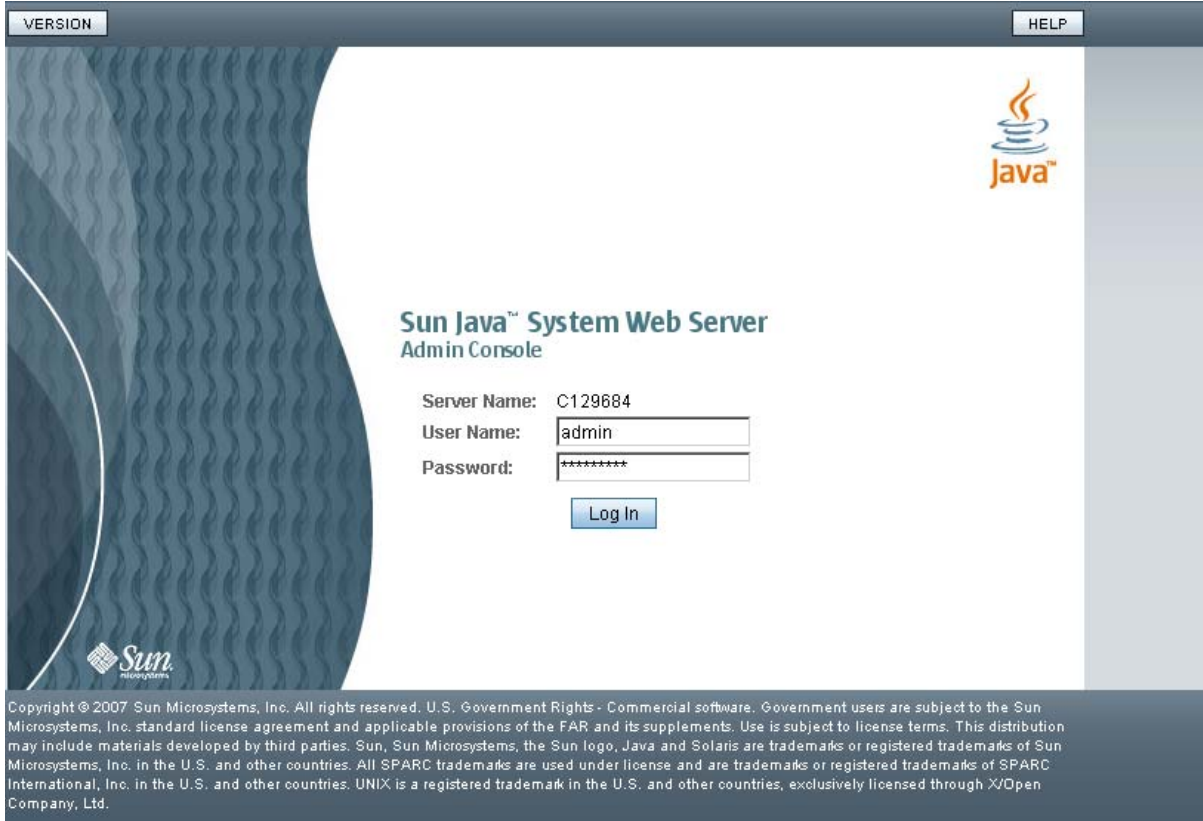

The screenshot shows the Sun Java System Web Server Admin Console login page. The page has a dark blue header with 'VERSION' and 'HELP' buttons. The main content area is white with a blue wavy background on the left. The Sun logo is in the bottom left. The Java logo is in the top right. The title is 'Sun Java™ System Web Server Admin Console'. The form fields are: Server Name: C129684, User Name: admin, Password: \*\*\*\*\*. A 'Log In' button is below the password field. A copyright notice is at the bottom.

VERSION HELP



**Sun Java™ System Web Server**  
Admin Console

Server Name: C129684  
User Name:   
Password:



Copyright © 2007 Sun Microsystems, Inc. All rights reserved. U.S. Government Rights - Commercial software. Government users are subject to the Sun Microsystems, Inc. standard license agreement and applicable provisions of the FAR and its supplements. Use is subject to license terms. This distribution may include materials developed by third parties. Sun, Sun Microsystems, the Sun logo, Java and Solaris are trademarks or registered trademarks of Sun Microsystems, Inc. in the U.S. and other countries. All SPARC trademarks are used under license and are trademarks or registered trademarks of SPARC International, Inc. in the U.S. and other countries. UNIX is a registered trademark in the U.S. and other countries, exclusively licensed through X/Open Company, Ltd.

5. The Common Tasks screen appears.

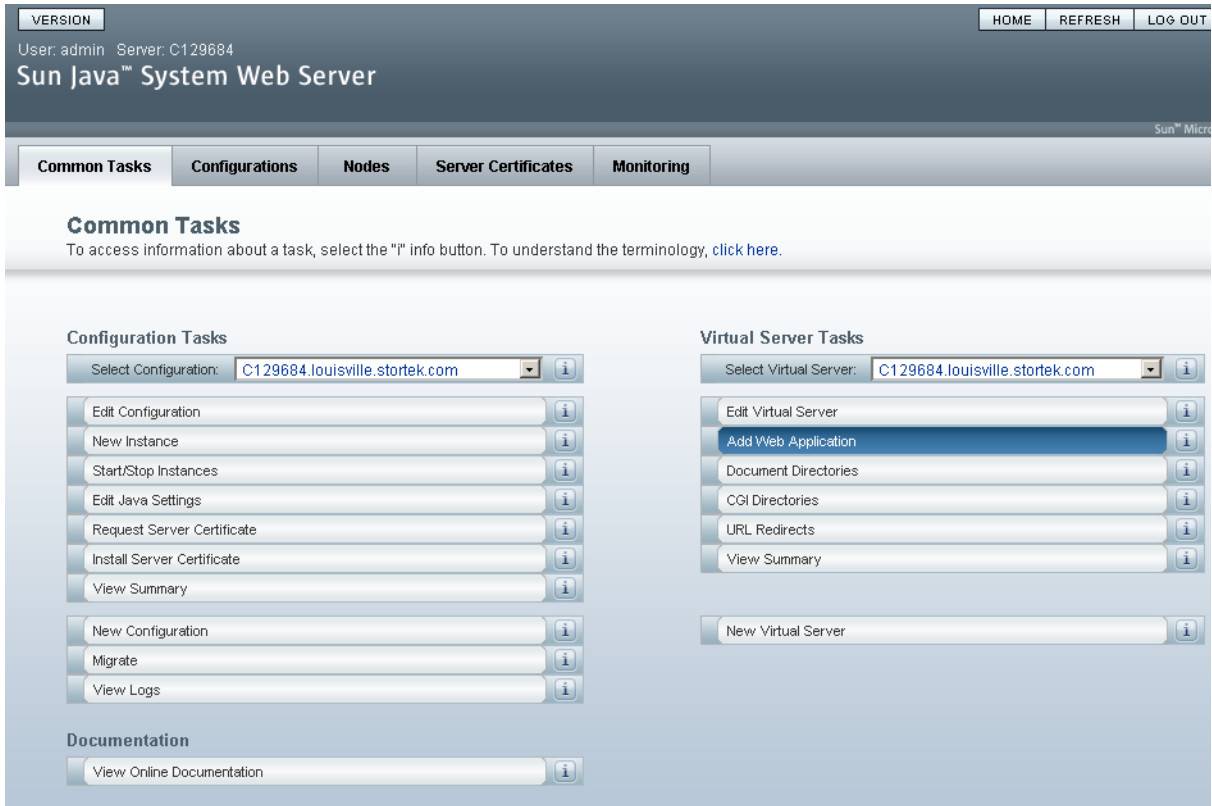

## ▼ Install and Deploy the Web-launched SL Console

**Note** – Before you perform this activity, you must obtain the Web-launched SL Console installation CD.

1. On the server, insert the Web-launched SL Console installation CD in the CD drive.
2. Log in to the Sun Java System Web Server administration console. See “Log in to the Java System Web Server Administration Console” on page 536 for details.
3. On the Common Tasks screen, click Add Web Application.

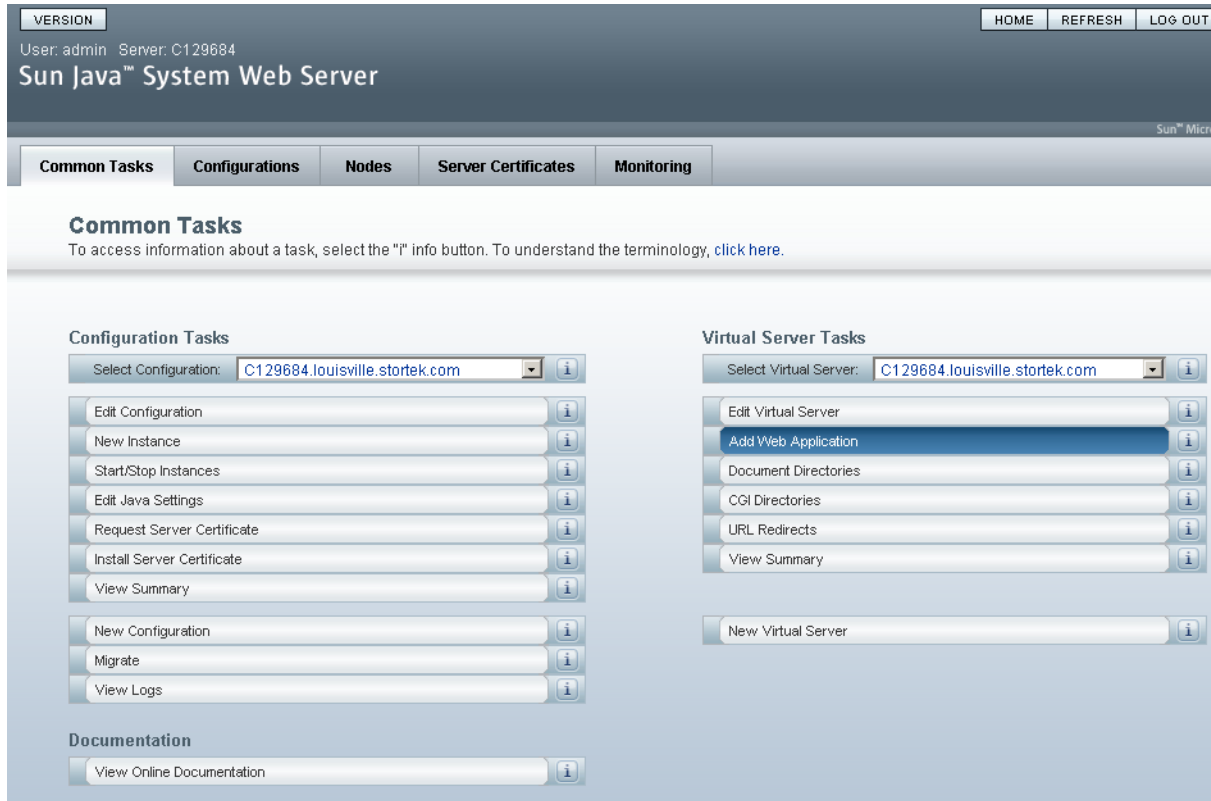

4. On the Add Web Application screen, make the following entries:
  - **Web Application Location:** Click the **Browse** button and browse to the location of the `opel.war` file on the installation CD.
  - **URI:** Type `/opel`
  - Leave all other fields as the defaults.

- Click OK.

## Sun Java™ System Web Server

### Add Web Application

Add Web Application from this page. You can add a web application archive (.war file) or specify the web application path in the server.

\* Indicates required field

Virtual Server:	C129684.louisville.stortek.com
Web Application Location:	<input checked="" type="radio"/> Specify a package file to upload to the Web Server. <input type="text" value="C:\SLC_WebLaunch\opel.war"/> <input type="button" value="Browse..."/>
	<input type="radio"/> Specify a package file or a directory path that must be accessible from the server. <input type="text"/>
* URI:	<input type="text" value="/opel"/> Specify the URI for your web application. This will be the application's context root and is relative to the server host
Target Directory:	<input checked="" type="radio"/> Default <input type="radio"/> This directory <input type="text"/> Directory to deploy the web application
Description:	<input type="text"/> Provide a short description about the application
JSP Pre-compilation:	<input type="checkbox"/> Enabled Enabling this directive will allow all the JSPs present in the web application to be pre-compiled to improve performance



## 5. On the Web Applications screen, click Save.

Configurations > C129684.louisville.stortek.com > Virtual Servers > C129684.louisville.stortek.com

[Server Settings](#)
[Web Applications](#)
[Content Handling](#)
[WebDAV](#)
[Search](#)
[Access Control](#)
[Summary](#)

### C129684.louisville.stortek.com - Virtual Server Web Applications [Save](#)

This page lets you add web applications to the virtual server. Web applications are added as web archive (.war) files. After adding the web application you need to deploy the configuration to propagate the added web applications to the instances. The page also allows you to set single signon properties.

[Single Signon](#)
[Web Applications](#)

---

#### Single Signon

Single Signon:  Enabled  
 Session Idle Timeout:  seconds (0.001 - 3600)  
Timeout after which user's single sign-on records becomes eligible for purging if no activity is seen (Use -1 for no timeout)

[Back to top](#)

---

#### Web Applications

**Web Applications (1)**

[New...](#)
[Enable](#)
[Disable](#)
[Update...](#)
[Delete](#)

<input checked="" type="checkbox"/>	URI	Enabled	Deployed Path	Description
<input type="checkbox"/>	/opel	true	..web-app/C129684.louisville.stortek.com/opel	

[Back to top](#)

[Save](#)

6. On the updated Web Applications screen, click the Deployment Pending link in the upper-right corner.

The screenshot shows the Sun Java System Web Server administration interface. At the top right, there is a navigation bar with buttons for HOME, REFRESH, LOG OUT, and HELP. Below this, a yellow warning box displays a triangle icon and the text 'Deployment Pending'. Underneath the warning, it says 'Instance(s) Running 0' and 'Instance(s) Stopped 1'. The main header area shows 'Sun Java™ System Web Server' and 'User: admin Server: C129684'. A breadcrumb trail indicates the current location: 'Configurations > C129684.louisville.stortek.com > Virtual Servers > C129684.louisville.stortek.com'. A menu bar below the breadcrumb contains 'Server Settings', 'Web Applications', 'Content Handling', 'WebDAV', 'Search', 'Access Control', and 'Summary'.

**Web Application Properties Saved Successfully**

**C129684.louisville.stortek.com - Virtual Server Web Applications**

Save

This page lets you add web applications to the virtual server. Web applications are added as web archive (.war) files. After adding the web application you need to deploy the configuration to propagate the added web applications to the instances. The page also allows you to set single signon properties.

Single Signon Web Applications

**Single Signon**

Single Signon:  Enabled

Session Idle Timeout:  seconds (0.001 - 3600)

Timeout after which user's single sign-on records becomes eligible for purging if no activity is seen. (Use -1 for no timeout)

Back to top

**Web Applications**

Web Applications (1)			
URI	Enabled	Deployed Path	Description
<input type="checkbox"/> /opel	true	..web-app/C129684.louisville.stortek.com/opel	

7. On the Configuration Deployment screen, click Deploy.



**Configuration Deployment**

Deploying configuration to all instances.

**Deployment Pending**  
 The configuration **C129684.louisville.stortek.com** has changed locally. Click on "Deploy..." to propagate the changes to all instances

Deploy... Cancel

8. On the Results screen, click Close.

Sun Java™ System Web Server

Results

 The configuration has been deployed successfully to all available nodes.

Close

9. The Web Applications screen displays a message that the application has been added successfully.

The screenshot shows the Sun Java System Web Server administration interface. At the top, there is a navigation bar with buttons for HOME, REFRESH, LOG OUT, and HELP. Below this, the user is identified as 'admin' and the server as 'C129684'. The main title is 'Sun Java™ System Web Server'. On the right, it shows 'Instance(s) Running 0' and 'Instance(s) Stopped 1'. A breadcrumb trail indicates the current location: 'Configurations > C129684.louisville.stortek.com > Virtual Servers > C129684.louisville.stortek.com'. A menu bar contains 'Server Settings', 'Web Applications', 'Content Handling', 'WebDAV', 'Search', 'Access Control', and 'Summary'. A yellow notification box in the center reads 'Web Application Added Successfully'.

C129684.louisville.stortek.com - Virtual Server Web Applications

Save

This page lets you add web applications to the virtual server. Web applications are added as web archive (.war) files. After adding the web application you need to deploy the configuration to propagate the added web applications to the instances. The page also allows you to set single signon properties.

Single Signon Web Applications

Single Signon

Single Signon:  Enabled

Session Idle Timeout: 300 seconds (0.001 - 3600)

Timeout after which user's single sign-on records becomes eligible for purging if no activity is seen (Use -1 for no timeout)

Back to top

Web Applications

Web Applications (1)			
	URI	Enabled	Deployed Path
<input checked="" type="checkbox"/>	/opel	true	..web-app/C129684.louisville.stortek.com/opel

You can click the **Home** button in the upper-right corner to return to the Common Tasks screen.

## ▼ Start the Web-launched SL Console

1. Log in to the Sun Java System Web Server administration console. See [“Log in to the Java System Web Server Administration Console”](#) on page 536 for details.
2. On the Common Tasks screen, click Start/Stop Instances.

The screenshot shows the Sun Java System Web Server administration console. At the top, there is a navigation bar with tabs for 'Common Tasks', 'Configurations', 'Nodes', 'Server Certificates', and 'Monitoring'. The 'Common Tasks' tab is selected. Below the navigation bar, the 'Common Tasks' section is displayed. It includes a header with the text 'Common Tasks' and a sub-header 'To access information about a task, select the "i" info button. To understand the terminology, [click here](#).' The main content area is divided into three sections: 'Configuration Tasks', 'Virtual Server Tasks', and 'Documentation'. The 'Configuration Tasks' section has a dropdown menu for 'Select Configuration:' set to 'C129684.louisville.stortek.com'. Below this are buttons for 'Edit Configuration', 'New Instance', 'Start/Stop Instances' (which is highlighted), 'Edit Java Settings', 'Request Server Certificate', 'Install Server Certificate', and 'View Summary'. The 'Virtual Server Tasks' section has a dropdown menu for 'Select Virtual Server:' set to 'C129684.louisville.stortek.com'. Below this are buttons for 'Edit Virtual Server', 'Add Web Application', 'Document Directories', 'CGI Directories', 'URL Redirects', and 'View Summary'. The 'Documentation' section has a button for 'View Online Documentation'. The top of the page shows the user 'admin' on server 'C129684' and the Sun Java logo.

3. On the Configuration Instances screen, click the checkbox next to the local instance of the Web-launched SL Console server, and click Start.

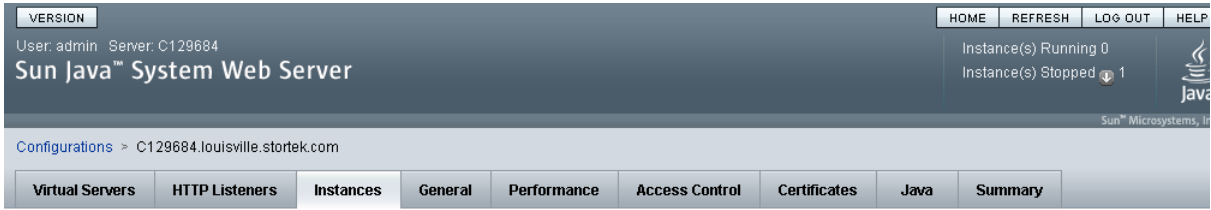

#### C129684.louisville.stortek.com - Configuration Instances

[View Logs...](#)

Instance refers to the environment of a web server daemon on a given node, including its configuration, log files and other runtime artifacts such as lock databases, caches and temporary files. An instance can be started, stopped, dynamically re-configured or deleted. You can perform all these actions from this page. The View Server Logs button brings up a popup that displays the logs for the instances on various nodes. If there are no instances, then the button is disabled.

Instances (1)		
Instance	Node	Instance State
<input checked="" type="checkbox"/> <a href="#">https-C129684.louisville.stortek.com</a>	<a href="#">c129684.louisville.stortek.com</a>	<span style="color: red;">●</span> Not Running

The Web-launched SL Console application instances are started, and screen with a progress bar is displayed.

4. On the Results screen, click Close.



**i Instance(s) Started Successfully**

Close

## ▼ Update the Web-launched SL Console

You can update the Web-launched SL Console while it is running. Updates are automatically propagated to the clients when they retrieve the Web-launched SL Console application from the server.

---

**Note** – Before you perform this activity, you must obtain the Web-launched SL Console update CD.

---

1. On the server, insert the Web-launched SL Console update CD in the CD drive.
2. Log in to the Sun Java System Web Server administration console. See “[Log in to the Java System Web Server Administration Console](#)” on page 536 for details.
3. On the Common Tasks screen, click **Edit Virtual Server**.

The screenshot shows the Sun Java System Web Server administration console interface. At the top, there is a navigation bar with 'VERSION', 'HOME', 'REFRESH', and 'LOG OUT' buttons. Below this, the user is logged in as 'admin' on server 'C129684'. The main navigation tabs are 'Common Tasks', 'Configurations', 'Nodes', 'Server Certificates', and 'Monitoring'. The 'Common Tasks' tab is active, displaying a list of tasks under two main categories: 'Configuration Tasks' and 'Virtual Server Tasks'. In the 'Virtual Server Tasks' section, the 'Edit Virtual Server' option is highlighted with a blue bar and a yellow tooltip that also says 'Edit Virtual Server'. Other tasks listed include 'Add Web Application', 'Document Directories', 'CGI Directories', 'URL Redirects', 'View Summary', and 'New Virtual Server'. A 'Documentation' section at the bottom offers to 'View Online Documentation'.

**4. On the General Properties screen, click the Web Applications tab.**

The screenshot shows the Sun Java System Web Server Administration Console. At the top, it displays the user 'admin' and server 'C129684'. The main title is 'Sun Java™ System Web Server'. On the right, there are navigation buttons: HOME, REFRESH, LOG OUT, and HELP. Below these, it shows 'Instance(s) Running 1' and 'Instance(s) Stopped 0'. The breadcrumb trail is 'Configurations > C129684.louisville.stortek.com > Virtual Servers > C129684.louisville.stortek.com'. A menu bar contains 'Server Settings', 'Web Applications', 'Content Handling', 'WebDAV', 'Search', 'Access Control', and 'Summary'. Below this, there are sub-menus: 'General', 'Log Preferences', 'Monitoring Settings', and 'Request Limits'. The main content area is titled 'C129684.louisville.stortek.com - Virtual Server General Properties' with a 'Save' button. A paragraph explains that all virtual servers have one or more HTTP Listeners. Below this are expandable sections: General, Quality of Service, P3P Settings, HTTP Listeners, Localization, and Variables. The 'General' section is expanded, showing fields for Name (C129684.louisville.stortek.com), Virtual Server (checked Enabled), Document Root (/docs), and Hosts (C129684.louisville.stortek.com). A 'Back to top' link is at the bottom.

**5. On the Web Applications screen, click the checkbox next to the /opel URI, and click Update.**

The screenshot shows the Sun Java System Web Server Administration Console with the 'Web Applications' tab selected. The breadcrumb trail is 'Configurations > C129684.louisville.stortek.com > Virtual Servers > C129684.louisville.stortek.com'. The menu bar is the same as in the previous screenshot. The main content area is titled 'C129684.louisville.stortek.com - Virtual Server Web Applications' with a 'Save' button. A paragraph explains that this page lets you add web applications to the virtual server. Below this are expandable sections: Single Signon and Web Applications. The 'Web Applications' section is expanded, showing a table with one entry. The table has columns for 'URI', 'Enabled', 'Deployed Path', and 'Description'. The entry for '/opel' has a checked checkbox in the 'URI' column and 'true' in the 'Enabled' column. A 'Back to top' link is at the bottom.

**6. On the Update Web Application screen, make the following entries:**



- **Web Application Location:** Click the **Browse** button and browse to the location of the `opel.war` file on the update CD.
- Leave all other fields as the defaults.
- Click **OK**.

## Sun Java™ System Web Server

### Update Web Application

Update Web Application from this page. You can specify a new web application archive(.war file).

<b>Virtual Server:</b>	C129684.louisville.stortek.com
<b>URI:</b>	/opel
<b>Target Directory:</b>	..web-app/C129684.louisville.stortek.com/opel
<b>Web Application Location:</b>	<input checked="" type="radio"/> Specify a package file to upload to the Web Server. <input type="text" value="C:\SLC_WebLaunch\opel.war"/> <input type="button" value="Browse..."/> <input type="radio"/> Specify a package file that must be accessible from the server. <input type="text"/>
<b>JSP Pre-compilation:</b>	<input type="checkbox"/> Enabled <small>Enabling this directive will allow all the JSPs present in the web application to be pre-compiled to improve performance</small>

The server update begins, and screen with a progress bar is displayed.

7. On the Web Applications screen, click the Deployment Pending link in the upper right corner.

The screenshot shows the Sun Java System Web Server administration interface. At the top, there is a navigation bar with 'HOME', 'REFRESH', 'LOG OUT', and 'HELP' buttons. Below this, the user is identified as 'admin' on server 'C129684'. The main title is 'Sun Java™ System Web Server'. On the right, there is a status section showing 'Deployment Pending' with a warning icon, 'Instance(s) Running 1', and 'Instance(s) Stopped 0'. Below the navigation bar, there are tabs for 'Server Settings', 'Web Applications', 'Content Handling', 'WebDAV', 'Search', 'Access Control', and 'Summary'. A yellow message box in the center reads 'Web Application Updated Successfully'. Below this, the page title is 'C129684.louisville.stortek.com - Virtual Server Web Applications' with a 'Save' button. The main content area has a breadcrumb trail: 'Single Signon > Web Applications'. Under 'Single Signon', there is a checkbox for 'Single Signon' which is currently unchecked, and a 'Session Idle Timeout' of '300' seconds. Below this is a 'Web Applications' section with a table header 'Web Applications (1)' and buttons for 'New', 'Enable', 'Disable', 'Update', and 'Delete'.

8. On the Configuration Deployment screen, click Deploy.

The screenshot shows the 'Configuration Deployment' screen. At the top, there is a dark header with 'Sun Java™ System Web Server'. Below this, the title is 'Configuration Deployment' with the subtitle 'Deploying configuration to all instances.' A yellow message box in the center contains a warning icon and the text 'Deployment Pending' followed by 'The configuration C129684.louisville.stortek.com has changed locally. Click on "Deploy..." to propagate the changes to all instances'. At the bottom right, there are two buttons: 'Deploy...' and 'Cancel...'.

The deployment begins, and screen with a progress bar is displayed.

9. In the Results screen, click **Close** to return to the Web Applications screen.

Sun Java™ System Web Server

Results

 The configuration has been deployed successfully to all available nodes.

Close

---

# Common Problems and Solutions

This section describes solutions to some common problems with the installation and maintenance of the Java System Web Server.

## Windows 2000 Sun Java System Web Server Installation Errors

### Windows MSVCP60.dll Error

If you are installing on a Windows 2000 platform that does not include the Microsoft Visual C v6 runtime DLL, MSVCP60 . dll, during installation you will see errors similar to the following:

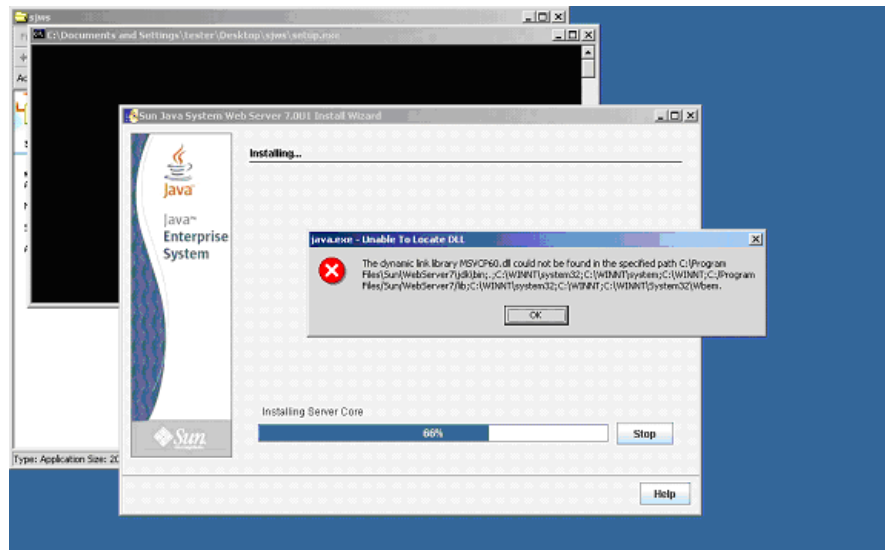

The Web server installation log will include errors similar to the following:

```

C:\Program Files\Sun\WebServer7\setup\Sun_Java_System_Web_Server_install.log
Nov 4, 2007 1:56:53 AM com.sun.web.admin.configurator.ConfigureServer createScripts
FINEST: ...done
Nov 4, 2007 1:56:53 AM com.sun.web.admin.configurator.ConfigureServer createProperties
FINEST: ConfigureServer.createProperties :: properties.length=1
Nov 4, 2007 1:56:53 AM com.sun.web.admin.configurator.ConfigureServer createProperties
FINEST: Replacing C:\Program Files\Sun\WebServer7\lib\install\templates\properties\common.properties.template to C:\Program Files\Sun\WebServer7\samples\java\webapps\common.properties...
Nov 4, 2007 1:56:53 AM com.sun.web.admin.configurator.ConfigureServer createProperties
FINEST: ...done
Nov 4, 2007 1:56:53 AM com.sun.web.admin.configurator.ConfigureServer configureServer
FINEST: Remove obsolete entries from the registry before installation...
Nov 4, 2007 2:00:21 AM com.sun.web.admin.configurator.ConfigureServer main
WARNING: C:\Program Files\Sun\WebServer7\lib\wsc\configurator.dll: Can't find dependent libraries
java.lang.UnsatisfiedLinkError: C:\Program Files\Sun\WebServer7\lib\wsc\configurator.dll: Can't find dependent libraries
    at java.lang.ClassLoader$NativeLibrary.load(Native Method)
    at java.lang.ClassLoader.loadLibrary0(ClassLoader.java:1751)
    at java.lang.ClassLoader.loadLibrary(ClassLoader.java:1676)
    at java.lang.Runtime.loadLibrary0(Runtime.java:822)
    at java.lang.System.loadLibrary(System.java:993)
    at com.sun.web.admin.configurator.WinServices.<clinit>(WinServices.java:93)
    at com.sun.web.admin.configurator.ConfigureServer.configureServer(ConfigureServer.java:579)
    at com.sun.web.admin.configurator.ConfigureServer.main(ConfigureServer.java:62)
Nov 4, 2007 2:00:21 AM com.sun.web.installer.web.actions.PostInstall_core configureServer
WARNING: Error while executing the backend configurator
Nov 4, 2007 2:00:21 AM com.sun.web.installer.web.actions.PostInstall_core configureServer
INFO: The status returned from the backend is 1
Nov 4, 2007 2:00:22 AM com.sun.web.installer.web.actions.PostInstall_core install
INFO: End core server configuration
Nov 4, 2007 2:00:22 AM com.sun.web.installer.web.actions.PostInstall_core createInfFile
INFO: Successfully created the install.inf file
Nov 4, 2007 2:00:22 AM com.sun.web.installer.web.actions.PostInstall_core copyMsgJar
INFO: Successfully copied the messages.jar file
Nov 4, 2007 2:00:22 AM com.sun.web.installer.web.actions.PostInstall_core moveUninstaller
INFO: Successfully moved the Uninstall class file to setup directory
.....
Log File: C:\Program Files\Sun\WebServer7\setup\Sun_Java_System_Web_Server_install.log
Dismiss
  
```

### ▼ Remedy for Windows MSVCP60.dll Error

Use this procedure to solve the Windows MSVCP60.dll error.

**1. Perform a Web search for the following string:**

msvc60.dll download

**2. Download the DLL file to the /winnt/system32 directory.**

**3. Delete the directory where you partially installed the Java System Web Server on the failed installation.**

**4. Repeat the Java System Web Server installation from the beginning.**

The installation should complete successfully with no recurrence of the error.

## ▼ Solaris 9 & 10 Sun Java System Web Server Installation Errors

### Java Home Error

If you cannot start the server instance and you see errors claiming your HotSpot start failed and your JVM could not be found, you need to change the Java Home configuration of your Sun Java System Web Server.

### ▼ Remedy for Solaris Java Home Error

Use this procedure to solve the Java Home error.

1. Log in to the Sun Java System Web Server administration console. See [“Log in to the Java System Web Server Administration Console”](#) on page 536 for details.
2. Select Home > Common Tasks.
3. Under Configuration Tasks, click Edit Java Settings.

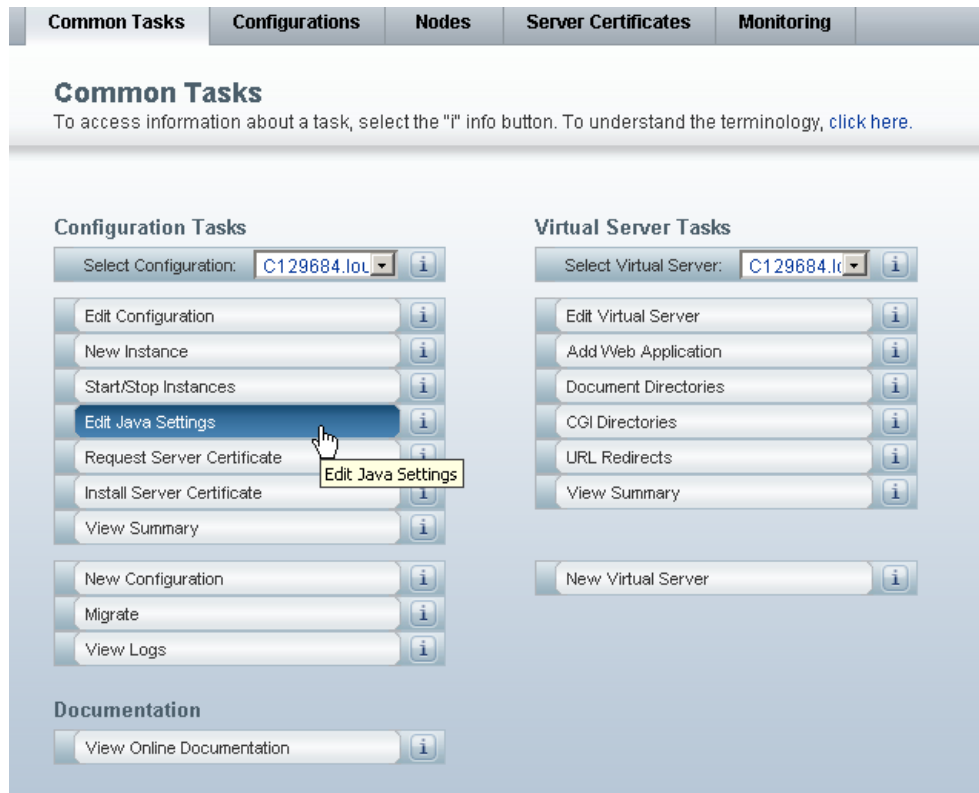

4. In Java Home, enter the directory where your JDK/JRE is installed. For example:

`/usr/java`

### C129684.louisville.stortek.com - JVM General Settings

Save

Enable Java for the selected configuration and view the server class path settings from this page.

[General](#)
[Path Settings](#)

\* Indicates required field

#### General

Enable Java:  Enabled

\* Java Home:

Location of the JDK

Sticky Attach:  Enabled

Whether the server attaches each HTTP request processing thread to the JVM only once

---

**Note** – You may also need to change permissions on the top-level directory where you installed the Sun Java System Web Server. In order for a non-root user to start a server instance, the user must be able to write to the server directory. For example, if you installed the server to the top-level directory `/opt/webserver7`, the user starting the server instance must be able to write to this directory and the `https-server_name` directory beneath it. For additional information see the Sun Java System Web Server site.

---





# Index

---

## A

AC power options 22

access door

audits and 484

closing 487

library initialization and 484

opening 486

safety interlocks 476

safety release 477

access door. *See* AEM access door *or* main access door.

Access Expansion Module. *See* AEM.

ACSLs 28–29

active storage regions

automatic assignment 224, 225

committing 236–238, 254–256

defining 233–235, 246–253

displaying 264–265

manual assignment 224

printing reports 241

reports 239–240, 257–263

saving reports 242

SL Console workspace 245, 254

SL Console workspace and 230

AEM

allocating to partitions 294, 362

associating to a partition 324

bulk load cartridges to a partition 326

bulk unload cartridges from a partition 327

described 15

emergency access 488–489

library partitions and 85, 275–279

non-disruptive maintenance and 85

override a reservation 329

properties 131

rebooting 472

removing partition associations 328

status 128

summary information 127

using to bulk load cartridges 84

using to bulk unload cartridges 84

wall diagrams 514

AEM access door 85

audits and 408, 488, 489

closing 136

described 84

fast access 488–489

AEM CAP

described 85

AEM operations

summarized 84–86

tasks 126–137

AEM safety door 85

described 84

properties 200

status 199

tasks 198–200

utility tasks 471–473

Any cartridge, Any slot technology 5

audits

access door and 484

AEM access door and 408

described 408–409

full library 438–439

library initialization and 484

main access door and 408

physical 408, 438–439, 440–441

range of cells 440–441

tasks 437–443

verified 409, 442–443

auto clean (drive)

described 92

SL3000 limitations 92

auto enter mode (CAPs)

described 80

library partitions and 276

automated mode (library) 30

described 73

determining 74

tasks 99–197

## B

barcode presentation 88, 147, 149

Base Module

described 7–8

- drive configurations 6
- physical capacity 6
- wall diagrams 510

bulk load operations 143, 326

bulk unload operations 327

## C

CAP allocations

- library partitions and 275

CAP associations

- library partitions and 279, 324
- removing 328, 399

CAP cells

- FC-SCSI address 505
- HLL-PRC address 503

CAP operations

- library partitions and 276
- summarized 79–277
- tasks 126–137

CAP reservations

- library partitions and 278–279
- overriding 329–331
- partitioned libraries and 277
- removing 402

capacity

- allocated (in partitioned libraries) 268
- licensed. *See* licensed capacity.
- non-disruptive changes. *See* non-disruptive capacity changes.
- of library modules 6
- physical 5, 224

Capacity on Demand 223–265

- features of 223
- terminology 224

CAPs

- auto enter mode 80
  - partitioned libraries and 276
- capacity of 19
- closing 80, 136
- library partitions and 82, 275–279, 323–331, 398–403
- library partitions and shared 276
- making available for diagnostic moves 138
- manual mode 80
- maximum 19
- maximum number of 19
- opening 79
- properties 131
- self-test 445
- states
  - library partitions and 80, 277
- status 128
- summary information 127
- using to eject cartridges 79
- using to enter cartridges 79
- utility tasks 444–449

- varying offline 446
- varying online 448

cartridge

- repairing detached leader block 524

cartridge access port. *See* CAP

cartridge access ports. *See* CAPs.

Cartridge Expansion Module. *See* CEM.

cartridge tapes

- requirements 519

cartridges

- applying labels 526
- barcode presentation 88, 147, 149
- bulk load 143
- cleaning. *See* cleaning cartridges.
- color specifications 519
- diagnostic 522
- ejecting from a partition 327
- ejecting through the CAP 79
- ejects 87
- entering into a partition 326
- entering through the CAP 79
- enters 87, 141
- exterior cleaning 524
- handling 522
- handling of 519–524
- home cell 87
- inserting in a cell or drive 522
- inserting in the CAP 87
- labels 520
- listing 151, 154
- loading through the AEM 84
- locating by address 88, 159
- locating by VOLID 88, 157
- LTO 521, 524
- management tasks 140–164
- mounts and dismounts 73
- ordering 525
- recovery moves 89, 161, 163
- requirements 519
- storing 524
- Sun StorageTek 521, 523
- unlabeled 87, 519, 523
- unloading through the AEM 84
- unreadable 523
- upside-down 523
- valid labels 519

cautions

- reentering cleaning cartridge 520
- solvents for cleaning a cartridge 524

CEM

- described 13
- physical capacity 6
- wall diagrams 512

CenterLine Technology 3, 491

cleaning cartridges 520

- described 91

- ejecting 184
- ejecting expired 91
- entering 183
- for LTO drives 522
- for Sun StorageTek drives 521
- listing 185
- status 91
- storage of 497
- command line interface 27
- configuration block
  - diagram 515
- control path 24–26
- cooling 23

**D**

- data path 26
- DC power supplies 22
- degraded mode (library) 31
- DEM 10–11
  - drive configurations 6
  - physical capacity 6
  - wall diagrams 511
- device status
  - listing codes 421
- diagnostic cartridges 520
  - ejecting 184
  - entering 183
  - for LTO drives 522
  - for Sun StorageTek drives 521
  - library self-tests and 406
- diagnostic moves (robot)
  - control functions 411–412
  - controlling 469
  - defining 458–462
  - described 410–412
  - managing definitions 463–464
  - monitoring 469
  - pool address range 410
  - random access order 411
  - robot selection 411
  - saving 465–466
  - sequential access order 411
  - starting 467–468
  - target address range 410
- diagnostic support files 415
- diagnostics
  - CAPs and 138
- dismount operations 74
- domain, media labels 520
- drive cleaning
  - automatic 92
  - configuring auto clean 181
  - described 91–93
  - ejecting cleaning cartridges 184
  - entering cleaning cartridges 183

- manual 92, 187
- status of 186
- tasks 180–187
- drive controller 110
- Drive Events Report 176
- Drive Expansion Module. *See* DEM.
- Drive Media Events Report 178
- drive slots
  - HLL-PRC address 90, 502
- drive trays 18
  - status 175
- drive VOP
  - displaying for T10000 172
- drives
  - addressing 90
  - cleaning. *See* drive cleaning.
  - cooling of 23
  - dynamic World Wide Name 508
  - FC-SCSI address 505
  - hardware numbering 507
  - LED status 174
  - management tasks 167–179
  - maximum 6, 90
  - network data 173
  - properties 171
  - SCSI FastLoad and 189, 191
  - self-test 451
  - states 90
  - status 170
  - summary information 168
  - supported 17
  - utility tasks 450–453
  - varying offline 452
  - varying online 453
- dynamic World Wide Name 90, 508
- dynamic World Wide Naming. *See* dWWN

**E**

- eject operations 87
  - partitioned libraries and 327
- emergency power-off. *See* emergency robotics stop
- Energy Monitor Reports 120, 122, 124
- enter operations 87, 141
  - partitioned libraries and 326
- event monitors
  - described 405
  - displaying 418
  - displaying multiple 420
  - spooling data to a file 419
  - tasks 417–423

**F**

- FC-SCSI address
  - CAP cell 505
  - drive 90, 505

- storage cell 504–506
- FC-SCSI interface 26, 111
  - displaying port status 107
- FC-SCSI interface
  - barcode presentation and 147, 149
  - FastLoad feature and 189, 191

## G

garage door. *See* AEM safety door.

## H

- health indicators 75
- HLI interface 24–26, 111
  - displaying port status 106
- HLI-PRC address
  - CAP cell 503
  - drive slot 90, 502
  - storage cell 499–501
- host interfaces
  - changing the type 111
  - FC-SCSI. *See* FC-SCSI interface. 107
  - HLI. *See* HLI interface. 106
  - non-partitioned libraries and 97, 111
  - partitioned libraries and 97, 267, 307, 309, 311, 342, 344, 346
- HSC 28–29

## J

- Java System Web Server
  - downloading 528–531
  - installing 532–535
  - logging in to the console 536–538

## L

- leader block, detached 524
- library addressing 24
  - FC-SCSI 504–506
  - HLI-PRC 499–503
  - library internal address 493–498
  - partitioned libraries and 270–273
- library automated mode 99–197
- library configuration
  - displaying 108
- Library Console. *See* SL Console
- library controller
  - properties 109
- library electronics
  - cooling of 23
- library events 405
- library events. *See Also* event monitors.
- library features 2
- library firmware upgrades 407
  - activating 430
  - downloading 428

- library initialization sequence 484
  - configuration block and 515
- library internal address
  - CAP cell 497
  - partitioned libraries and 270–273
  - storage cell 493–496
- library management software 28–29
- library management tasks 100–119
- library operating modes 30–31
- library partitions
  - AEM associations and 324
  - allocated capacity 268
  - allocating an AEM CAP 294
  - barcode presentation and 149
  - boundaries of 270
  - CAP allocations and 275
  - CAP associations and 279, 324, 328, 399
  - CAP operations 276
  - CAP reservations and 278–279, 329–331, 402
  - CAP states and 80, 277
  - committing 300, 371, 374
  - configuration requirements 267
  - configuration tasks 283, 286–302
  - creating 288, 348
  - deleting 305, 350
  - deleting the Partitioning feature 270
  - described 267
  - design and commit screen reference 353–378
  - designing 270, 291, 356
  - displaying 243, 321
  - ejecting cartridges from 327
  - entering cartridges into 326
  - features of 267
  - hosts and 267, 269, 289, 307, 309, 311, 342, 344, 346
  - installing the Partitioning feature 268
  - library hardware changes and 315
  - library resources and 273, 314, 377
  - licensed capacity and 225
  - modifying summary information 304, 351
  - orphaned cartridges in 273, 299, 388
  - planning 268–270
  - printing reports 319
  - reports 316–320, 379–397
  - saving reports 320
  - SCSI FastLoad feature and 191
  - shared CAPs and 276, 279
  - SL Console workspace and 284, 313, 371
  - summary screen reference 333–352
  - task summary 285
  - using AEMs in 275–279
  - using CAPs in 82, 275–279
  - verifying 296, 368
- library power down 483
- library power up 484–485
- library reboot 426
- library reports 77

- displaying 114
- saving data to a file 118
- searching 116
- library self-tests 406
  - performing 425
- library status
  - displaying 101
- library utility tasks 424–436
- license expirations 202
- license key file
  - comparing to current features 206–208, 219, 221
  - deleting 270
  - described 201
  - displaying contents of 206–208
  - file type 201
  - installing 203, 209–211, 216–218, 221
  - library serial number and 201, 207, 210, 217
  - licensed capacity and 223
  - overlying 201
  - receiving 205
- licensed capacity 223–265
  - active cells 224
  - active storage regions 224, 225
    - automatic assignment 225
    - committing 236–238, 254–256
    - defining 233–235, 246–253
    - displaying 264–265
    - printing reports 241
    - reports 239–240, 257–263
    - saving reports 242
    - SL Console workspace 245, 254
    - SL Console workspace and 230
  - cell activation rules 225, 269
  - changes and FC-SCSI connections 228
  - changes and HLI connections 227
  - de-activating 225
  - decreasing 229
  - inactive cells 224
  - increasing 229
  - increments of 223
  - installing 230
  - license key file and 223
  - management tasks 230–242
  - minimum and maximum 223
  - non-partitioned libraries and 225
  - orphaned cartridges and 226, 262–263
  - partitioned libraries and 225, 268
  - screen reference 245–265
  - selected cells 224
- licensed features
  - Capacity on Demand 223–265
  - deleting 270
  - displaying current 212, 214
  - installing 203, 268
  - Partitioning 267–403
  - redundant robot 21

- licensing screen reference 213–222
- licensing tasks 203–212
- local operator panel
  - described 40–41
  - entering data 40
  - factory alignment 41
  - logging in 48
  - pen and stylus 40
  - re-calibrating 41, 62–64
  - resetting calibration to factory settings 65
  - touch-screen 40
  - virtual keypad 40
- log snapshot file
  - described 415
  - transfer process 434–436
- login IDs 34
- LTO
  - repairing detached leader block 524

## M

- main access door
  - audits and 408
  - automated mode and 74
- maintenance mode (library) 30
- Management Information Base. See MIB file.
- manual CAP 80
- manual cleaning (drive) 92, 187
- manual mode (library) 30
- manual operations
  - safety precautions 475–477
    - access door interlocks 476
    - access door release 477
    - general 475
    - physical restrictions 477
    - server power interrupt 476
  - tasks 478–487
- media
  - domain labels 520
  - ID labels 520
- Media Events Report 165
- MIB file
  - described 415
  - transfer process 432–433
- mixed-media support 5
- modules 3
  - AEM 15
  - Base Module 7–8
  - capacity 5
  - CEM 13
  - DEM 10–11
  - PEM 14
- mount operations 73

## N

NDP. *See* non-disruptive partitioning.  
NearLine Control Solution 28  
non-disruptive capacity changes 227  
non-disruptive partitioning  
    FC-SCSI partitions and 281  
    HLI partitions and 280

## O

orphaned cartridges  
    non-partitioned libraries and 226  
    partitioned libraries and 273, 299, 388

## P

Parking Expansion Module. *See* PEM.  
partitioned library. *See* library partitions.  
partitioning  
    non-disruptive. *See* non-disruptive partitioning.  
partitions. *See* library partitions.  
passwords  
    modifying 60  
PEM  
    described 14  
    physical capacity 6  
    wall diagrams 513  
physical capacity 5, 224  
    of library modules 6  
power down the library 483  
power redundancy 22  
power source options 22  
power supplies 22, 96  
    cooling of 23  
    monitoring tasks 188–197  
    status of 197  
    summary information 196  
power up the library 484–485

## R

RealTimeGrowth 223  
reboot  
    library 426  
recovery moves 89  
repairing detached leader block 524  
reserved cells 496  
    diagram 517  
result codes  
    listing 423  
robot  
    bar code scanner 21  
    faulty 523  
    described 20–21, 94  
    diagnostic moves. *See* diagnostic moves.  
    monitoring tasks 188–197

    properties 195  
    redundant 21  
    SCSI FastLoad and 189, 191  
    self-test 455  
    status of 194  
    summary information 193  
    utility tasks 454–470  
    varying offline 456  
    varying online 457  
row numbering, diagram 516

## S

safety door. *See* AEM safety door.  
safety precautions 475–477  
    access door interlocks 476  
    access door release 477  
    general 475  
    physical restrictions 477  
    servo power interrupt 476  
SCSI FastLoad 189, 191  
self-tests  
    CAP 445  
    drive 451  
    library 406, 425  
    robot 455  
SL Console  
    activation password 34  
    active storage region workspace and 230, 245, 254  
    communications failures 76  
    described 27, 33  
    first-time access 34  
    layout of screen 35  
    local operator panel. *See* local operator panel.  
    logging off 59  
    login IDs 34  
    modes 33  
    modifying passwords 60  
    modifying the screen display 36  
    partition workspace and 284, 313, 371  
    security 34  
    standalone. *See* standalone SL Console  
    Web-launched. *See* Web-launched SL Console  
SL Console Help  
    accessing 38  
    described 38  
    navigation 38  
SL Console reports  
    Drive Events 176  
    Drive Media Events 178  
    Energy Monitor 120, 122, 124  
    Media Events 165  
    Options Bar 77  
    types 77  
SLC. *See* SL Console  
SNMP  
    library support of 27

- transferring the library MIB file 432–433
- standalone SL Console
  - described 44–45
  - installing 67–71
  - installing updates 45
  - logging in 58
- status alerts
  - clearing 104
  - described 78
  - displaying 102
- Status Module. *See* status alerts.
- storage cells
  - FC-SCSI address 504–506
  - HLI-PRC address 499–501
  - library internal address 493–496
  - physical capacity 5
  - wall diagrams 509–517
- StorageTek Library Console. *See* SL Console

- described 42–43
- downloading the Java System Web Server 528–531
- installation errors 552
- installing on the server 539–544
- installing the Java System Web Server 532–535
- Java WebArchive file 527
- logging in to the Java System Web Server 536–538
- logging in using a browser 49–53
- logging in using an icon 54–57
- security 42, 527
- server described 527–555
- server requirements 527
- starting on a client 43
- starting on the server 545–546
- updating on a client 42
- updating on the server 547–551
- World Wide Name. *See* dWWN

## T

- T9940
  - repairing detached leader block 524
- TallBot. *See* robot.
- tape drives. *See* drives
- tape drives. *See* drives.
- TCP/IP interface 24–26
- transferring the log snapshot file 434–436
- troubleshooting 413

## U

- User's Guide
  - Cautions xxxii
  - conventions xxxiii
  - Notes xxxii
  - Warnings xxxii

## V

- vary the library offline 479–480
- vary the library online 481–482
- VOP
  - displaying for T10000 drives 172

## W

- wall diagrams
  - AEM 514
  - Base Module 510
  - CEM 512
  - configuration block 515
  - DEM 511
  - PEM 513
  - reserved cells 517
  - row numbering 516
- Web-launched SL Console
  - client requirements 42







Sun Microsystems, Inc. 4150 Network Circle, Santa Clara, CA 95054 USA Phone 1-650-960-1300 or 1-800-555-9SUN Web [sun.com](http://sun.com)



ARGENTINA: 5411-4317-5636 • AUSTRALIA: 1-800-550-786 • AUSTRIA: 43-1-601-26-0 • BALKANS: 301-6188-111 • BELGIUM: 32-2-704 89 83 • BRAZIL: 55-11-51872100 • BRUNEI: 65-216-8333 • CANADA: 1-800-422-8020 (GENERAL); 416-964-2001 (LEARNING MANAGEMENT SYSTEM SALES, TORONTO) • CHILE: 562-372-4500 • COLOMBIA: 571-629-2323  
CZECH REPUBLIC: 420 2 33009311 • DENMARK: 45 4556 5040 • EGYPT: 00 202 570 9442 • FINLAND: 358-9-525-551 • FRANCE: 33-1-41-33-17-17 • GERMANY: 49-89-460-08-2788 • GREECE: 30-01-6188101 • HONG KONG: 852-2877-7077 • HUNGARY: 361-202-4415 • INDIA: 91-80-229-8989 • INDONESIA: 65-216-8333 • IRELAND: 353-1-668-4377  
ISRAEL: 972-9-9710500 • ITALY: 39-02-9259511 • JAPAN: 81-3-5779-1820 • KOREA: 82-2-3453-6602 • MALAYSIA: 603-2116-1887 • MIDDLE EAST: 00 9714 3366333 • MEXICO: 525-261-0344 • NETHERLANDS: 31-33-4515200 • NEW ZEALAND: 0800-786-338 • NORTH WEST AFRICA: 00 9714 3366333 • NORWAY: FROM NORWAY: 47-22023950, TO NORWAY: 47-23369650 • PAKISTAN: 00-9714-3366333 • PEOPLE'S REPUBLIC OF CHINA: 8610-6803-5588 • PHILIPPINES: 632-885-7867 • POLAND: 48-22-8747848 • PORTUGAL: 351-21-413-4000 • RUSSIA: 7-095-935-8411 • SAUDI ARABIA: 00 9714 3366333 • SINGAPORE: 65-216-8300 • SOUTH AFRICA: 27-11-256-6300 • SPAIN: 34-902-210-412 • SRI LANKA: 65-2168333 • SWEDEN: 46-8-631 22 00 • SWITZERLAND: 41-1-908-90-50 (GERMAN) 41-22-999-0444 (FRENCH) • TAIWAN: 886-2-25185735 • THAILAND: 662-344-6855 • TURKEY: 90 212 335 22 00 • UNITED KINGDOM: 44-1276-416-520 • UNITED STATES: 1-800-422-8020 • VENEZUELA: 582-905-3800 • VIETNAM: 65-216-8333 • WORLDWIDE HEADQUARTERS: 1-650-960-1300

**SUN™** THE NETWORK IS THE COMPUTER ©2006 Sun Microsystems, Inc. All rights reserved. Sun, Sun Microsystems, and the Sun logo are trademarks or registered trademarks of Sun Microsystems, Inc. in the United States and other countries.