

Sun StorEdge™ DDS-4 Tape Drive Installation and User's Guide

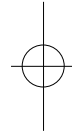
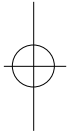

THE NETWORK IS THE COMPUTER™

Sun Microsystems, Inc.
901 San Antonio Road
Palo Alto, CA94303-4900 USA
650 960-1300 Fax 650 969-9131

Part No.: 806-3313-10
Revision A, November 1999

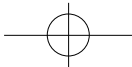

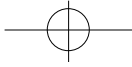

Copyright 1999 Sun Microsystems, Inc. 901 San Antonio Road • Palo Alto, CA94303-4900 USA. All rights reserved.

This product or document is protected by copyright and distributed under licenses restricting its use, copying, distribution, and decompilation. No part of this product or document may be reproduced in any form by any means without prior written authorization of Sun and its licensors, if any. Third-party software, including font technology, is copyrighted and licensed from Sun suppliers.

Parts of this product may be derived from Berkeley BSD systems, licensed from the University of California. UNIX is a registered trademark in the U.S. and other countries, exclusively licensed through X/Open Company, Ltd. For Netscape Communicator™, the following notice applies: Copyright 1995 Netscape Communications Corporation. All rights reserved.

Sun, Sun Microsystems, the Sun logo, StorEdge, AnswerBook2, docs.sun.com, SunVTS, SunDiag, and Solaris are trademarks, registered trademarks, or service marks of Sun Microsystems, Inc. in the U.S. and other countries. All SPARC trademarks are used under license and are trademarks or registered trademarks of SPARC International, Inc. in the U.S. and other countries. Products bearing SPARC trademarks are based upon an architecture developed by Sun Microsystems, Inc.

The OPENLOOK and Sun™ Graphical User Interfaces was developed by Sun Microsystems, Inc. for its users and licensees. Sun acknowledges the pioneering efforts of Xerox in researching and developing the concept of visual or graphical user interfaces for the computer industry. Sun holds a non-exclusive license from Xerox to the Xerox Graphical User Interface, which license also covers Sun's licensees who implement OPEN LOOK GUIs and otherwise comply with Sun's written license agreements.

RESTRICTED RIGHTS: Use, duplication, or disclosure by the U.S. Government is subject to restrictions of FAR 52.227-14(g)(2)(6/87) and FAR 52.227-19(6/87), or DFARS 252.227-7015(b)(6/95) and DFAR 227.7202-3(a).

DOCUMENTATION IS PROVIDED "AS IS" AND ALL EXPRESS OR IMPLIED CONDITIONS, REPRESENTATIONS AND WARRANTIES, INCLUDING ANY IMPLIED WARRANTY OF MERCHANTABILITY, FITNESS FOR A PARTICULAR PURPOSE OR NON-INFRINGEMENT, ARE DISCLAIMED, EXCEPT TO THE EXTENT THAT SUCH DISCLAIMERS ARE HELD TO BE LEGALLY INVALID.

Copyright 1999 Sun Microsystems, Inc., 901 San Antonio Road • Palo Alto, CA94303-4900 Etats-Unis. Tous droits réservés.

Ce produit ou document est protégé par un copyright et distribué avec des licences qui en restreignent l'utilisation, la copie, la distribution, et la décompilation. Aucune partie de ce produit ou document ne peut être reproduite sous aucune forme, par quelque moyen que ce soit, sans l'autorisation préalable et écrite de Sun et de ses bailleurs de licence, s'il y en a. Le logiciel détenu par des tiers, et qui comprend la technologie relative aux polices de caractères, est protégé par un copyright et licencié par des fournisseurs de Sun.

Des parties de ce produit pourront être dérivées du système Berkeley BSD licenciés par l'Université de Californie. UNIX est une marque déposée aux Etats-Unis et dans d'autres pays et licenciée exclusivement par X/Open Company, Ltd. La notice suivante est applicable à Netscape Communicator™ : Copyright 1995 Netscape Communications Corporation. All rights reserved.

Sun, Sun Microsystems, the Sun logo, StorEdge, AnswerBook2, docs.sun.com, SunVTS, SunDiag, et Solaris sont des marques de fabrique ou des marques déposées, ou marques de service, de Sun Microsystems, Inc. aux Etats-Unis et dans d'autres pays. Toutes les marques SPARC sont utilisées sous licence et sont des marques de fabrique ou des marques déposées de SPARC International, Inc. aux Etats-Unis et dans d'autres pays. Les produits portant les marques Sparc sont basés sur une architecture développée par Sun Microsystems, Inc.

L'interface d'utilisation graphique OPEN LOOK et Sun™ a été développée par Sun Microsystems, Inc. pour ses utilisateurs et licenciés. Sun reconnaît les efforts de pionniers de Xerox pour la recherche et le développement du concept des interfaces d'utilisation visuelle ou graphique pour l'industrie de l'informatique. Sun détient une licence non exclusive de Xerox sur l'interface d'utilisation graphique Xerox, cette licence couvrant également les licenciés de Sun qui mettent en place l'interface d'utilisation graphique OPENLOOK et qui en outre se conforment aux licences écrites de Sun.

CETTE PUBLICATION EST FOURNIE "EN L'ETAT" ET AUCUNE GARANTIE, EXPRESSE OU IMPLICITE, N'EST ACCORDEE, Y COMPRIS DES GARANTIES CONCERNANT LA VALEUR MARCHANDE, L'APTITUDE DE LA PUBLICATION A REpondre A UNE UTILISATION PARTICULIERE, OU LE FAIT QU'ELLE NE SOIT PAS CONTREFAISANTE DE PRODUIT DE TIERS. CE DENI DE GARANTIE NE S'APPLIQUERAIT PAS, DANS LAMESURE OU IL SERAIT TENU JURIDIQUEMENT NULET NON AVENU.

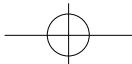

Sun StorEdge™ DDS-4 Tape Drive Installation and User's Guide



The Sun StorEdge™ DDS-4 tape drive (Figure 1) is equipped with an ultra-wide SCSI-2 (small computer system interface) controller and 8 Mbyte data buffer. The tape drive has a data transfer rate of 3 Mbyte per second before the additional enhancement of data compression, and 6 Mbytes per second with compression (assuming a typical compression ratio of 2 to 1).

This SCSI device is in compliance with ANSI/ECMA DDS, DDS-DC and DDS-4 storage device format standards.

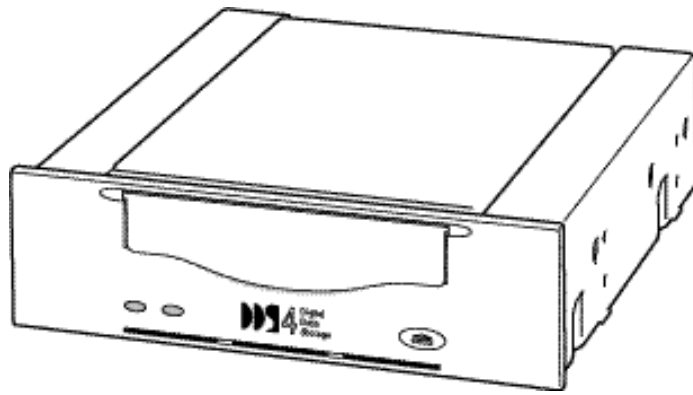

Figure 1 Sun StorEdge™ DDS-4 Tape Drive



Physical Characteristics

Table 1 Physical Characteristics

Height	41.3 mm (1.6 inches)
Width	146 mm (5.7 inches)
Depth	162 mm (6.4 inches)
Weight	0.98 kg (2.16 pounds, including 5.25" mounting bracket)

Data Transfer Rates

Table 2 Data Transfer Rates

Maximum sustained native	3 Mbytes per second
Maximum burst asynchronous	6 Mybytes per second
Maximum burst synchronous	40 Mybytes per second

Power Requirements

Table 3 Power Requirements

DC voltage	+12 Vdc \pm 10%	+5 Vdc \pm 5%
Operational current		
Steady State	400 mA	500 mA
Maximum	1.2 A	850 mA

Note – On powering up, both supplies should come up within one second of each other. On powering down, the 12V supply should stay within a \pm 10% limit until the 5V supply drops below 4.5V.

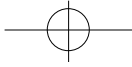

Panel Descriptions

This section contains descriptions of the front and back panels of the DDS-4 tape drive.

Front Panel Control and Indicators

The tape drive has an activity light and an attention light on the front panel. (Figure 2).

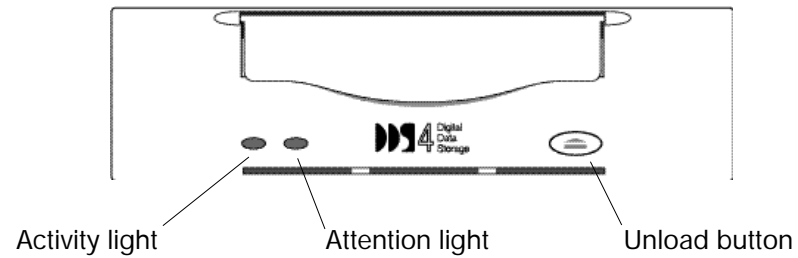

Figure 2 Front Panel Controls and Indicators

Activity Light

- Flashes green to show activity (loading, unloading, reading, and writing)
- Is a steady green when a cartridge is loaded and the tape drive is ready to begin operations

Attention Light

- Flashes amber to indicate that a cartridge is near the end of its life or that the heads need cleaning (see "Media Caution Signal" on page 6)
- Is a steady amber when there is a hard fault

Refer to Figure 3 for more detail.

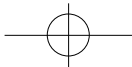

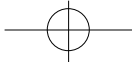

Activity Attention	Descriptions	Key
	Activity-load or unload	Off
	Activity-read or write	Green
	Cartridge loaded	Amber
	Media Caution signal	Flash green (1/2s on, 1/2s off)
	Fault	Flash amber (1/2s on, 1/2s off)
	Power-on (starts with two steady lights)	Fast flash green (1/4s on, 1/4s off)

Figure 3 Descriptions of Light Patterns

Media Caution Signal

The Sun StorEdge™ DDS-4 tape drive monitors the number of correctable errors that occur during reading and writing. If the number of errors becomes excessive, the tape may be nearing the end of its useful life, or the tape heads may need cleaning.

- If the Media Caution signal appears (flashing amber), clean the tape drive as described in “Cleaning the Tape Drive” on page 16.
- If the signal still displays after cleaning the heads, repeat the operation with a different tape. If this clears the signal, the first tape is nearing the end of its life. Copy the data onto a new tape and discard the old one.

The Media Caution signal is cleared when a new tape is loaded or when the drive is power-cycled.

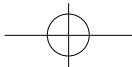

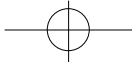

Back Panel Connections

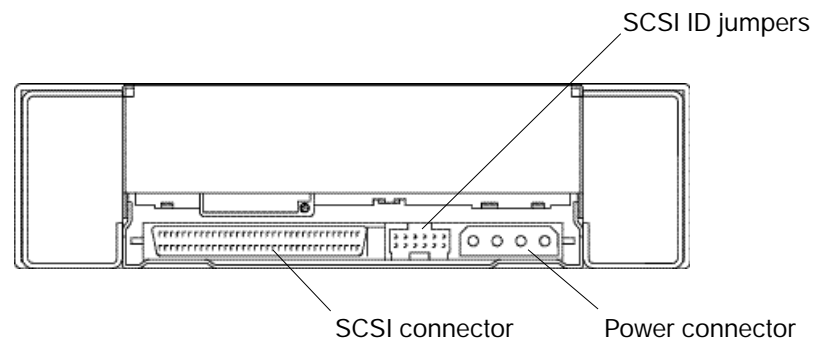

Figure 4 Rear View of Sun StorEdge™ DDS-4 Tape Drive

Installing the Tape Drive

Installing the tape drive involves the following steps:

- Determining an available SCSI ID within your system
- Setting the SCSI ID jumpers on the tape drive
- Installing the tape drive into your system or enclosure
- Configuring the tape drive for operation with your system

The following section describes how to identify and set the SCSI ID. Refer to your enclosure or system documentation for instructions on how to install a tape drive.

After installing your tape drive, refer to “Software Commands” on page 9 for information about modifying the system files and configuring your system.

Setting the SCSI ID Jumpers

Refer to the *Answerbook* documentation that corresponds to the version of your operating environment to determine available SCSI target IDs. If you do not have a handbook and would like to order one, visit <http://docs.sun.com/> and follow the appropriate links.

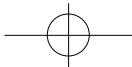

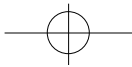

For Enclosures With Target ID Selector Switches

1. Connect the SCSI ID cable from the target ID switch on the interior back panel of the enclosure to the ID cable on the tape drive (Figure 5).

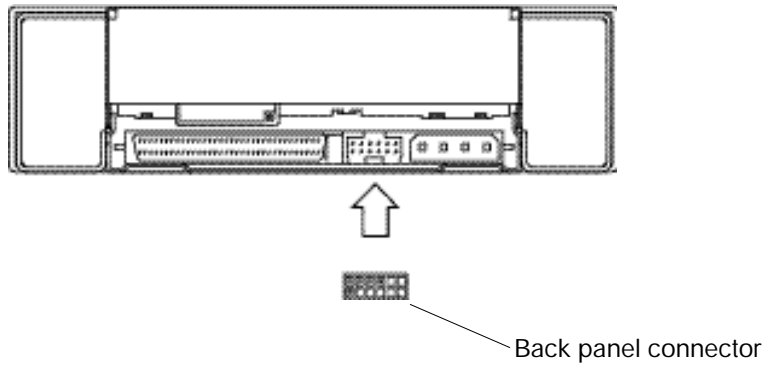

Figure 5 Location of SCSI Address Jumpers

2. Set the target ID selector switch on the enclosure to an available SCSI ID address (tape drives are normally 4 or 5).

For Enclosures Without Target ID Selector Switches

- ◆ Identify an available SCSI ID (tape drives are normally 4 or 5), and then configure the jumpers on the rear of the drive according to Figure 6.

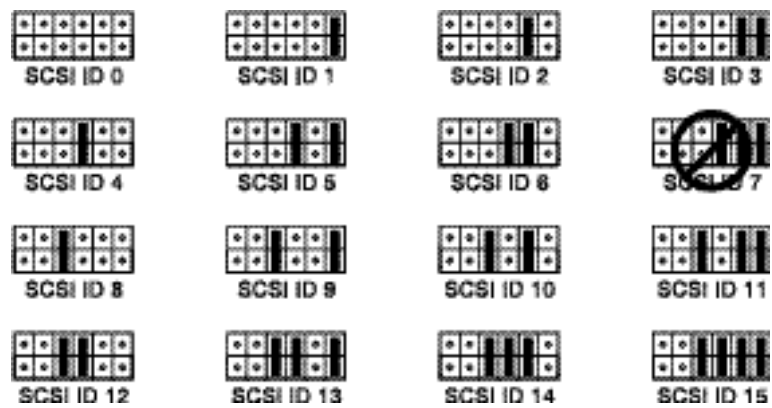
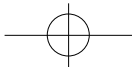
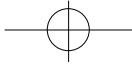

Figure 6 Setting SCSI Address Jumpers





For Systems With Narrow (50 Pin) SCSI Connectors

1. Connect the 50 way SCSI cable from the host to the 68/50 SCSI adapter assembly (Figure 7).
2. Connect the 68/50 SCSI adapter assembly to the tape drive (Figure 7).

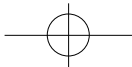
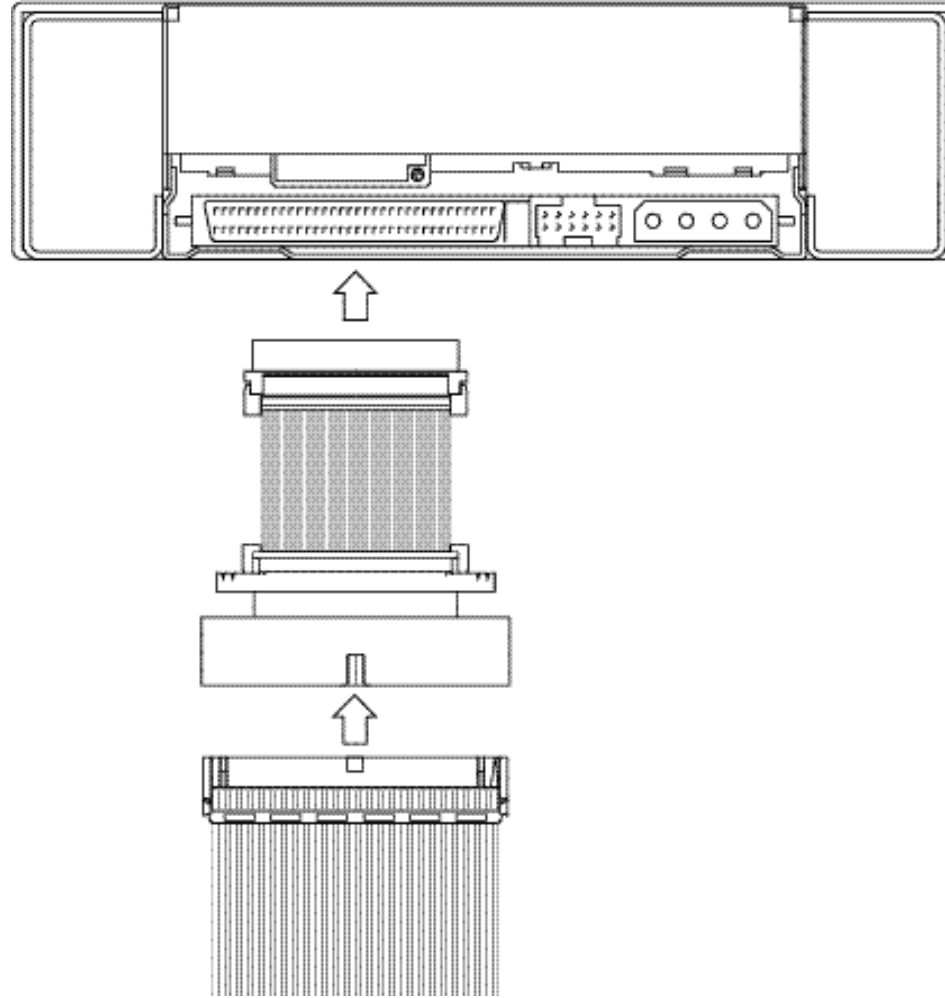



Software Commands

For information about software commands, refer to the *AnswerBook* documentation for your operating environment. The *Answerbook* also describes how to determine which SCSI target IDs are available and how to configure your system after installation. If you do not have a handbook and would like to order one, visit <http://docs.sun.com/> and follow the appropriate links.

Modifying Configuration Files

Depending upon the operating system you have, follow the appropriate procedures

Operating Environments

The Solaris™ operating environment recognizes all tape drives and autoloaders that were supported by Sun when your operating environment was released. If your system uses Solaris releases 2.5.1, 2.6, or 7--all of which were released before the DDS-4 tape drive--you must obtain the appropriate patch listed in Table 4 below so that your operating system will recognise the DDS-4 drive. Please contact your Sun authorized service provider for the current patch revision levels (denoted below by **).

Table 4 Patch Requirements

Operating Environment	Patch-ID
Solaris 2.5.1	103857-**
Solaris 2.6	105847-**
Solaris 7	107460-**

Kernel Modification Procedures

Read this entire procedure before installing patches or editing the `st.conf` file.

Note – The syntax is critical. Verify the placement of commas, semicolons, and beginning and ending quotation marks. Some numerical fields are preceded by `0x`.



1. **Become superuser and install the appropriate patch for your system listed in Table 4 by referring to the README file included with the patch. Do not modify the `st.conf` file--skip Steps 2 and 3, continue to Step 4, and follow the procedure to halt the system.**

Note – Editing the `st.conf` file manually by following steps 2 and 3 below is strongly discouraged. The patches enable the DDS-4 device on their respective operating environments without any `st.conf` file modifications. Steps 2 and 3 below are included only for reference and for situations where an `st.conf` entry is absolutely unavoidable.

2. **Become superuser and make a copy of the original `st.conf` file `/kernel/drv/st.conf` as a backup (`st.conf.old`).**

```
%su
Password:

#cp /kernel/drv/st.conf st.conf.old
```

3. **Edit the `st.conf` file.**

Using an editor, scroll through the `st.conf` file to the following line:

```
# tape-config-list=
```

- a. **Delete the # character that begins the line, if it hasn't already been removed. (# = comment line).**
- b. **Using the editor, continue to scroll until you come to the following line entry:**

```
# "HP      C1539A",      "HP DDS-2 4mm DAT",      "HP_DAT",
```

- c. **On the next lines, add the following entry exactly as shown (Note there are *six spaces* between "HP" and "C5683A.")**

```
"HP      C5683A",      "HP DDS-4 4mm DAT",      "HP_DAT_4";
```

Note – Do not use a # character at the beginning of the line just added. The # character is used to comment-out a specific line entry.



Note – If multiple devices are enabled (lines uncommented), only the *last* uncommented line with this format needs to end with a semicolon. All previous lines with this format *must* end with a comma.

d. Using the editor, continue to scroll until you come to the following line entry:

```
#HP_DAT      =      1,0x34,0,0x19679,1,0x0,0;
```

e. On the next line, add the following entry exactly as shown:

```
HP_DAT_4     =      1,0x34,0,0x9639,4,0x00,0x8c,0x8c,0x8c,1;
```

Note – Do not begin this line with a # character.

Note – This should be the last line entry and *must* end with a semi-colon.

f. Save the file as `st.conf`.

4. Halt the system following the normal procedure.

5. Reboot the system with the `-r` option to recognize the drive:

```
ok boot -r
```

Watch the boot messages for any indications of problems with the `st.conf` entry.

Note any indicated line numbers. If any error messages occur, edit the `st.conf` file again and then reboot.

6. Install a tape cartridge in the tape drive and allow the drive to fully load the cartridge.

7. Verify that the `st.conf` entry is correct.

```
%mt -f /dev/rmt/0 status
```

You may need to replace the 0 with 1, 2 and so on, until you find the number that the system has identified for this drive.

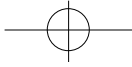

- **DAT tape drive indicates a Sun StorEdge™ DDS-4 tape drive that is correctly recognized. The specific Sense Key returned is usually not an issue.**
- **No Additional Sense indicates that there are no error conditions.**
- **Unit Attention indicates that the drive has just been powered on or that a tape has just been inserted.**

Undesired Responses from the Drive

- **SCSI tape drive indicates the `st.conf` entry is incorrect. You must edit the `st.conf` file and reboot until you no longer see SCSI Tape Drive.**
- **No tape loaded or drive offline indicates there is no cartridge in the drive or that the cartridge is not yet loaded. Install a cartridge or wait for the cartridge load to complete and retry the `mt status` command.**
- **No such file or directory indicates there is no tape drive attached to that `rmt` (remote) number. Try another `rmt` number.**

Other Sources of Information

- **Check the man pages for additional information on software commands.**

The man page for the `mt` command lists numerous helpful commands. This is accessed by typing `man mt`.

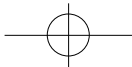



Upgrading Firmware From Tape

You can upgrade firmware by inserting a firmware upgrade cartridge.



Caution – Do not disconnect the power at any time during a firmware upgrade, particularly when the front panel lights are flashing. This may result in the drive having corrupt firmware or no firmware at all.

To upgrade firmware:

- 1. Ensure that the drive is not engaged in any SCSI activity (the Activity light is off and the host is not going to be accessing the drive).**
- 2. Insert the firmware upgrade cartridge into the drive.**
- 3. Wait while the upgrade process takes place.**
During the actual erasure and reprogramming of the firmware, it is critically important that you do not power down the drive. The front panel lights flash rapidly during this critical time.
- 4. When the upgrade is complete (after about two minutes), the drive ejects the cartridge. Remove the cartridge and replace it in its box.**

Note the following:

- If the firmware upgrade is incompatible with your hardware, no upgrade will take place. The drive will eject the cartridge after about 30 seconds instead of the usual two minutes.
- The firmware upgrade cartridge must not be write-protected.
- The firmware upgrade cartridge can only be used a certain number of times. After that, the drive will reformat it for normal data use, although it is not advisable to use it for data.
- You cannot convert a firmware upgrade tape for normal data use.

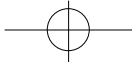

Cleaning the Tape Drive

Do not use any method other than a DDS-approved cleaning tape cartridge to clean your tape drive. Clean the heads as follows:

Table 5 Head Cleaning Schedule

No. of DDS Cartridges Used Each Day	Cleaning Interval
1 or less	8 weeks
2	4 weeks
3	3 weeks
4 or more	Weekly

Tape Cartridge Information

This tape drive uses 4mm DDS (90m, 120m, 125m and 155m length) data cartridges which have typical native storage capacities of 2 – 20 Gbytes.

The cartridges do not require preformatting.

Table 6 4mm Data Cartridge Storage Capacity

Format	Length	Native Capacity	Compressed Capacity ¹
DDS-DC	90m	2.0 Gbytes	4.0 Gbytes
DDS-2	120m	4.0 Gbytes	8.0 Gbytes
DDS-3	125m	12.0 Gbytes	24.0 Gbytes
DDS-4	150m	20.0 Gbytes	40.0 Gbytes

1. Assumes a typical compression ratio of 2:1 – compression will vary depending upon the type of data being compressed.



Caution – Never use DAT audio media. Always use computer grade media with a DDS/DDS-1, DDS-2, DDS-3 or DDS-4 logo.

Thermal Conditioning

To assure proper thermal conditioning, keep the cartridge at the same temperature as the drive for 24 hours before using.

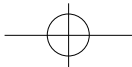



Handling and Storage

- Keep cartridges away from anything magnetic.
- Store cartridges in a dust-free environment.
- Keep cartridges away from direct sunlight and sources of heat, cold, or humidity. Constant room temperature and 50% humidity is best.
- Do not open the cartridge door and touch the surface of the tape.

Inserting a Tape Cartridge

1. Make sure all tape drive Attention and Activity lights are off.
2. Set the write-protect switch on the tape cartridge (Figure 8) for the desired operation. The switch is open for write-protected and closed for write-enabled.
3. Insert the cartridge face up into the drive.
4. Push gently on the tape until the unit pulls the cartridge into the drive.

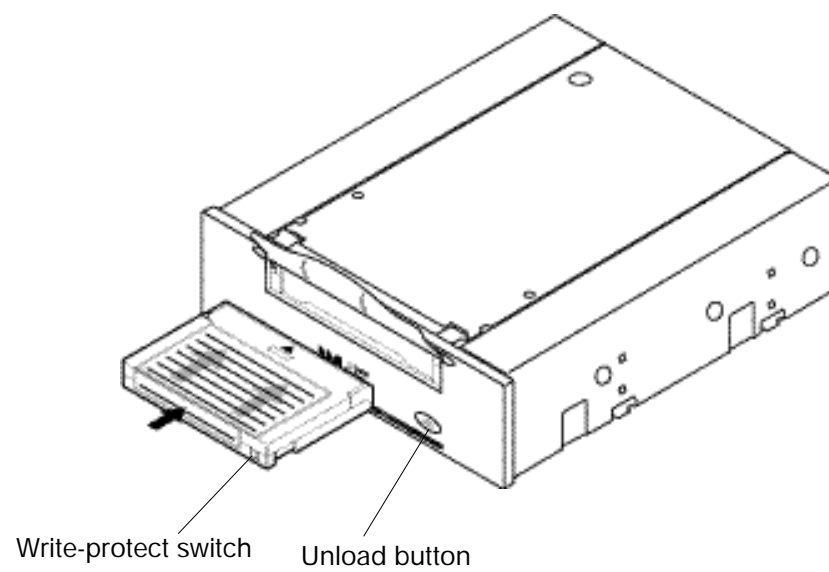
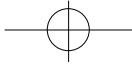

Figure 8 Inserting a Tape Cartridge



Removing a Tape Cartridge

- ◆ To remove a cartridge, press the unload button or issue a SCSI “unload” command.



Caution – Check the activity light to ensure there is no drive activity before ejecting the tape cartridge.

If the tape drive is free of errors, it performs the following actions in about one minute:

- Completes any command in process
- Writes any buffered information to tape
- Rewinds the tape to the beginning
- Unloads the tape and ejects the cartridge

Note – If an error occurs before or during the unload procedure, the tape drive suspends the unload sequence. To clear the error, press the eject button again. The tape drive reattempts the unload sequence, but does not write data in the buffer.

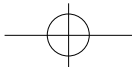

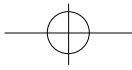

Accessing Sun Documentation Online

The `docs.sun.com`sm web site enables you to access Sun technical documentation on the Web. You can browse the `docs.sun.com` archive or search for a specific book title or subject at:

<http://docs.sun.com/>

Sun Welcomes Your Comments

We are interested in improving our documentation and welcome your comments and suggestions. You can email your comments to us at: or fax your comments to us. Please include the part number or your document in the subject line of your email or fax message.

`docfeedback@sun.com`

Please include the part number (806-3313-10) of your document in the subject line of your email.

