



Sun™ Ultra™ 60 Reference Manual

Sun Microsystems, Inc.
901 San Antonio Road
Palo Alto, CA 94303-4900 U.S.A.
650-960-1300

Part No.: 805-1762-11
Revision A, August 2001

Send comments about this document to: docfeedback@sun.com

Copyright 2001 Sun Microsystems, Inc., 901 San Antonio Road, Palo Alto, CA 94303-4900 U.S.A. All rights reserved.

This product or document is distributed under licenses restricting its use, copying, distribution, and decompilation. No part of this product or document may be reproduced in any form by any means without prior written authorization of Sun and its licensors, if any. Third-party software, including font technology, is copyrighted and licensed from Sun suppliers.

Parts of the product may be derived from Berkeley BSD systems, licensed from the University of California. UNIX is a registered trademark in the U.S. and other countries, exclusively licensed through X/Open Company, Ltd.

Sun, Sun Microsystems, the Sun logo, AnswerBook2, docs.sun.com, and Solaris are trademarks, registered trademarks, or service marks of Sun Microsystems, Inc. in the U.S. and other countries. All SPARC trademarks are used under license and are trademarks or registered trademarks of SPARC International, Inc. in the U.S. and other countries. Products bearing SPARC trademarks are based upon an architecture developed by Sun Microsystems, Inc. The Energy Star logo is a registered trademark of EPA.

The OPEN LOOK and Sun™ Graphical User Interface was developed by Sun Microsystems, Inc. for its users and licensees. Sun acknowledges the pioneering efforts of Xerox in researching and developing the concept of visual or graphical user interfaces for the computer industry. Sun holds a non-exclusive license from Xerox to the Xerox Graphical User Interface, which license also covers Sun's licensees who implement OPEN LOOK GUIs and otherwise comply with Sun's written license agreements.

Federal Acquisitions: Commercial Software—Government Users Subject to Standard License Terms and Conditions.

DOCUMENTATION IS PROVIDED "AS IS" AND ALL EXPRESS OR IMPLIED CONDITIONS, REPRESENTATIONS AND WARRANTIES, INCLUDING ANY IMPLIED WARRANTY OF MERCHANTABILITY, FITNESS FOR A PARTICULAR PURPOSE OR NON-INFRINGEMENT, ARE DISCLAIMED, EXCEPT TO THE EXTENT THAT SUCH DISCLAIMERS ARE HELD TO BE LEGALLY INVALID.

Copyright 2001 Sun Microsystems, Inc., 901 San Antonio Road, Palo Alto, CA 94303-4900 Etats-Unis. Tous droits réservés.

Ce produit ou document est distribué avec des licences qui en restreignent l'utilisation, la copie, la distribution, et la décompilation. Aucune partie de ce produit ou document ne peut être reproduite sous aucune forme, par quelque moyen que ce soit, sans l'autorisation préalable et écrite de Sun et de ses bailleurs de licence, s'il y en a. Le logiciel détenu par des tiers, et qui comprend la technologie relative aux polices de caractères, est protégé par un copyright et licencié par des fournisseurs de Sun.

Des parties de ce produit pourront être dérivées des systèmes Berkeley BSD licenciés par l'Université de Californie. UNIX est une marque déposée aux Etats-Unis et dans d'autres pays et licenciée exclusivement par X/Open Company, Ltd.

Sun, Sun Microsystems, le logo Sun, AnswerBook2, docs.sun.com, et Solaris sont des marques de fabrique ou des marques déposées, ou marques de service, de Sun Microsystems, Inc. aux Etats-Unis et dans d'autres pays. Toutes les marques SPARC sont utilisées sous licence et sont des marques de fabrique ou des marques déposées de SPARC International, Inc. aux Etats-Unis et dans d'autres pays. Les produits portant les marques SPARC sont basés sur une architecture développée par Sun Microsystems, Inc.

L'interface d'utilisation graphique OPEN LOOK et Sun™ a été développée par Sun Microsystems, Inc. pour ses utilisateurs et licenciés. Sun reconnaît les efforts de pionniers de Xerox pour la recherche et le développement du concept des interfaces d'utilisation visuelle ou graphique pour l'industrie de l'informatique. Sun détient une licence non exclusive de Xerox sur l'interface d'utilisation graphique Xerox, cette licence couvrant également les licenciés de Sun qui mettent en place l'interface d'utilisation graphique OPEN LOOK et qui en outre se conforment aux licences écrites de Sun.

LA DOCUMENTATION EST FOURNIE "EN L'ETAT" ET TOUTES AUTRES CONDITIONS, DECLARATIONS ET GARANTIES EXPRESSES OU TACITES SONT FORMELLEMENT EXCLUES, DANS LA MESURE AUTORISEE PAR LA LOI APPLICABLE, Y COMPRIS NOTAMMENT TOUTE GARANTIE IMPLICITE RELATIVE A LA QUALITE MARCHANDE, A L'APTITUDE A UNE UTILISATION PARTICULIERE OU A L'ABSENCE DE CONTREFAÇON.



Adobe PostScript

Contents

Preface xi

How This Book Is Organized xi

Related Documents xii

- 1. Back Panel Connectors 1-1**
 - 1.1 Connector Layout 1-2
 - 1.2 Serial Connectors 1-3
 - 1.3 Parallel Connector 1-4
 - 1.4 Keyboard/Mouse Connector 1-5
 - 1.5 Media Independent Interface (MII) Connector 1-6
 - 1.5.1 MII Cable-Type Connectivity 1-7
 - 1.5.2 External Cable Lengths 1-7
 - 1.5.3 External Transceivers 1-7
 - 1.6 Twisted-Pair Ethernet (TPE) Connector 1-8
 - 1.6.1 TPE Cable-Type Connectivity 1-8
 - 1.6.2 External UTP-5 Cable Lengths 1-9
 - 1.7 SCSI Connector 1-9
 - 1.7.1 SCSI Implementation 1-10
 - 1.7.2 SCSI Cabling Procedure 1-14

1.7.3	SCSI-2 (Fast/Wide SCSI) External Devices	1-15
1.8	Audio Ports	1-16
1.9	Audio Specifications	1-18
1.10	Graphics Card 13W3 Video Connector	1-19
2.	Modem Setup Specifications	2-1
2.1	Setting Up the Modem	2-1
2.2	Serial Port Speed Change	2-2
2.3	Recommendations	2-2
2.3.1	Cable	2-2
2.3.2	Modem Switch Settings (AT Commands)	2-3
3.	Motherboard Jumpers	3-1
3.1	Identifying Jumpers	3-3
3.2	Flash PROM Jumpers	3-4
3.3	Serial Port Jumpers	3-5
4.	System Specifications	4-1
4.1	Power Specifications	4-1
4.2	Environmental Specifications	4-2
4.3	Physical Specifications	4-3
4.4	Memory Mapping	4-4
4.4.1	DIMM Installation Guidelines	4-4
4.4.2	DIMM Banks and Slots	4-4
4.5	PCI Card Slot Specifications	4-6
4.5.1	Locating the PCI Card Slots	4-6
4.5.2	PCI Card Slot Operating Frequencies	4-8

Figures

- FIGURE 1-1 Back Panel Switches and Connectors 1-2
- FIGURE 1-2 DB-25 Serial Connectors 1-3
- FIGURE 1-3 DB-25 Parallel Connector 1-4
- FIGURE 1-4 DIN-8 Keyboard/Mouse Connector 1-5
- FIGURE 1-5 40-Pin Miniature-D MII Connector 1-6
- FIGURE 1-6 RJ-45 TPE Connector 1-8
- FIGURE 1-7 68-Pin SCSI Connector 1-9
- FIGURE 1-8 Configuration for the SCSI Bus 1-11
- FIGURE 1-9 SCSI Subassembly Functional Block Diagram 1-13
- FIGURE 1-10 Connecting External Mass Storage Devices 1-15
- FIGURE 1-11 Audio Port Locations 1-16
- FIGURE 1-12 13W3 Video Connector 1-19
- FIGURE 3-1 Jumper Locations on the Motherboard 3-2
- FIGURE 3-2 Identifying Jumper Pins 3-3
- FIGURE 4-1 Ultra 60 System Enclosure Physical Dimensions 4-3
- FIGURE 4-2 Map of DIMM Banks and Slots on Motherboard 4-5
- FIGURE 4-3 PCI Card Slot Locations on the System Unit Back Panel 4-6
- FIGURE 4-4 PCI Card Slot Locations on the Motherboard 4-7

Tables

TABLE 1-1	RS-423/RS-232 Serial Connector Pinouts	1-3
TABLE 1-2	Parallel Connector Pinouts	1-4
TABLE 1-3	Keyboard/Mouse Connector Pinouts	1-5
TABLE 1-4	MII Connector Pinouts	1-6
TABLE 1-5	MII External Cable Lengths	1-7
TABLE 1-6	MII Connectivity: Supported Transceivers	1-7
TABLE 1-7	TPE Connector Pinouts	1-8
TABLE 1-8	TPE UTP-5 Cable Lengths	1-9
TABLE 1-9	68-Pin SCSI Connector Pinouts	1-9
TABLE 1-10	SCSI Target Devices	1-12
TABLE 1-11	Determining SCSI Bus Length	1-14
TABLE 1-12	Audio Port Signals	1-16
TABLE 1-13	Audio Port Functions	1-17
TABLE 1-14	Audio Inputs and Output	1-18
TABLE 1-15	Internal Monaural Speaker Specifications	1-18
TABLE 1-16	13W3 Video Connector Pinouts	1-19
TABLE 3-1	User-Configurable Jumpers	3-3
TABLE 3-2	Flash PROM Jumper Settings	3-4
TABLE 3-3	Serial Port Jumper Settings	3-5
TABLE 4-1	Power Specifications	4-1

TABLE 4-2	Power Supply Outputs	4-1
TABLE 4-3	Environmental Specifications: Operating	4-2
TABLE 4-4	Environmental Specifications: Nonoperating	4-2
TABLE 4-5	Dimensions and Weight	4-3
TABLE 4-6	DIMM Banks and Slots	4-4
TABLE 4-7	PCI Card Slot Operating Frequencies	4-8

Preface

The *Sun Ultra 60 Reference Manual* contains information about the use and maintenance of an Ultra™ 60 system. It also includes information about configuring system communications settings.

The revision of the *Sun Ultra 60 Reference Manual* provided here is the latest version of the document, and includes information that may be different from that contained in the reference documentation originally shipped with the Sun Ultra 60 system.

How This Book Is Organized

Chapter 1, “Back Panel Connectors,” shows the location of each back panel connector and gives the pinouts for each connector.

Chapter 2, “Modem Setup Specifications,” gives modem settings for Ultra 60 systems used in specific network telecommunication applications.

Chapter 3, “Motherboard Jumpers,” gives the locations and pin definitions of user-configurable motherboard jumpers.

Chapter 4, “System Specifications,” gives system requirements about power and environment, and also gives system dimension, weight, memory mapping, and peripheral component interconnect (PCI) card slot specifications.

Related Documents

The following documents contain topics that relate to the information in the *Sun Ultra 60 Reference Manual*.

TABLE P-1 Related Documents

Application	Title	Part Number
Installation	<i>Sun Ultra 60 Installation Guide</i>	805-1707
Service	<i>Sun Ultra 60 Service Manual</i>	805-1709

Accessing Sun Documentation Online

A broad selection of Sun system documentation is located at:

<http://www.sun.com/products-n-solutions/hardware/docs>

A complete set of Solaris documentation and many other titles are located at:

<http://docs.sun.com>

Ordering Sun Documentation

Fatbrain.com, an Internet professional bookstore, stocks select product documentation from Sun Microsystems, Inc.

For a list of documents and how to order them, visit the Sun Documentation Center on Fatbrain.com at:

<http://www.fatbrain.com/documentation/sun>

Sun Welcomes Your Comments

Sun is interested in improving its documentation and welcomes your comments and suggestions. You can email your comments to Sun at:

`docfeedback@sun.com`

Please include the part number (805-1762-11) of your document in the subject line of your email.

Back Panel Connectors

This chapter contains specifications for the back panel connectors on the Ultra 60 system.

1.1 Connector Layout

FIGURE 1-1 shows the locations of Ultra 60 system back panel switches and connectors.

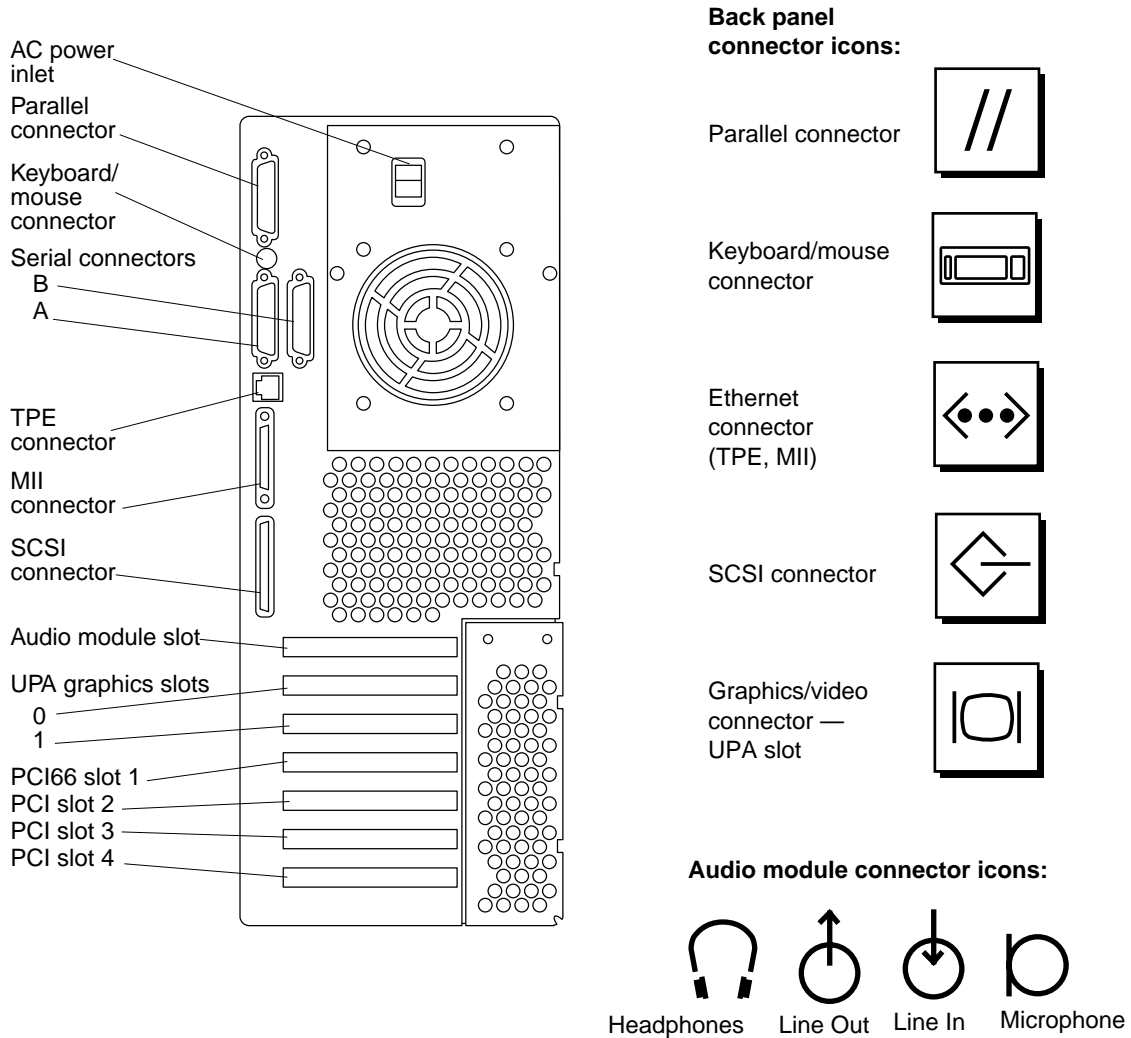

FIGURE 1-1 Back Panel Switches and Connectors

1.2 Serial Connectors

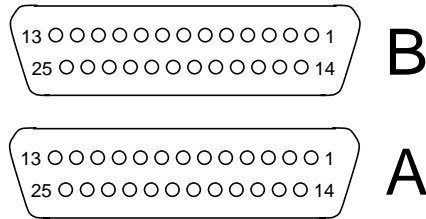

FIGURE 1-2 DB-25 Serial Connectors

TABLE 1-1 RS-423/RS-232 Serial Connector Pinouts

Pin	Function	I/O	Signal Description
1	none	none	Not connected
2	TxD	O	Transmit Data
3	RxD	I	Receive Data
4	RTS	O	Ready To Send
5	CTS	I	Clear To Send
6	DSR	I	Data Set Ready
7	Gnd		Signal Ground
8	DCD	I	Data Carrier Detect
9–14	none	none	Not connected
15	TRxC	I	Transmit Clock
16	none	none	Not connected
17	RTxC	I	Receive Clock
18–19	none	none	Not connected
20	DTR	O	Data Terminal Ready
21-23	none	none	Not connected
24	TxC	O	Transmit Clock
25	none	none	Not connected

Note: For information about serial port jumpers on the Ultra 60 system motherboard, see Section 4.1, “Identifying Jumpers,” and Section 4.3, “Serial Port Jumpers.”

1.3 Parallel Connector

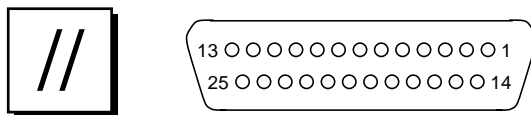

FIGURE 1-3 DB-25 Parallel Connector

TABLE 1-2 Parallel Connector Pinouts

Pin	Description	Pin	Description
1	Data_Strobe_L	14	AFXN_L
2	Data0	15	ERROR_L
3	Data1	16	RESET_L
4	Data2	17	IN_L
5	Data3	18	Ground
6	Data4	19	Ground
7	Data5	20	Ground
8	Data6	21	Ground
9	Data7	22	Ground
10	ACK_L	23	Ground
11	BUSY	24	Ground
12	PERROR	25	Ground
13	SELECT_L		

1.4 Keyboard/Mouse Connector

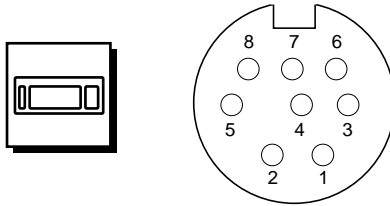

FIGURE 1-4 DIN-8 Keyboard/Mouse Connector

TABLE 1-3 Keyboard/Mouse Connector Pinouts

Pin	Description	Pin	Description
1	Ground	5	Keyboard_Data_Out_L
2	Ground	6	Keyboard_Data_In_L
3	Power	7	Poweron_L
4	Mouse_Data_In_L	8	Power

Note – All signals are standard TTL levels. The +5V supply is fuse-protected.

1.5 Media Independent Interface (MII) Connector

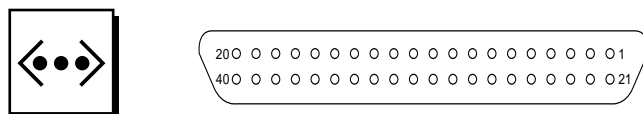

FIGURE 1-5 40-Pin Miniature-D MII Connector

TABLE 1-4 MII Connector Pinouts

Pin	Function	Pin	Function
1	+5V	18	COL
2	MDIO	19	CRS
3	MDC	20	+5V
4	RXD<3>	21	+5V
5	RXD<2>	22	Signal Ground
6	RXD<1>	23	Signal Ground
7	RXD<0>	24	Signal Ground
8	RX_DV	25	Signal Ground
9	RX_CLK	26	Signal Ground
10	RX_ER	27	Signal Ground
11	TX_ER	28	Signal Ground
12	TX_CLK	29	Signal Ground
13	TX_EN	30	Signal Ground
14	TXD<0>	31	Signal Ground
15	TXD<1>	32	Signal Ground
16	TXD<2>	33	Signal Ground
17	TXD<3>	34	Signal Ground
35	Ground	38	Signal Ground
36	Ground	39	Signal Ground
37	Ground	40	+5V

1.5.1 MII Cable-Type Connectivity

The following types of Ethernet cables can be connected to the 40-pin MII connector when using specific interface conversion devices:

- Shielded twisted-pair (STP)
- Unshielded twisted-pair (UTP)
- Fiber (connected to an external transceiver)

1.5.2 External Cable Lengths

TABLE 1-5 MII External Cable Lengths

Cable Type	Application(s)	Maximum Length (Metric)	Maximum Length (English)
40-conductor (20 signal-ground STP)	All external MII	0.5 meter	20 inches
UTP-5, “data grade”	10BASE-T	100 meters*	109 yards*
UTP-5, “data grade”	100BASE-T	100 meters*	109 yards*

* IEEE 802.3

1.5.3 External Transceivers

TABLE 1-6 MII Connectivity: Supported Transceivers

Cable Type	Transceiver Model and Application	Transceiver Manufacturer
Thick coaxial-cable Ethernet	XF467A, MII to AUI, 10BASE-5	Sun MII-to-AUI
UTP-3, “voice grade”	CT4-1030, 100BASE-T4	Canary Communications
Fiber	6211 Micro, Fast Ethernet, 100BASE-FX	Transcast Corporation
Fiber	CFX-107X, Fast Ethernet, 100BASE-FX	Canary Communications

1.6 Twisted-Pair Ethernet (TPE) Connector

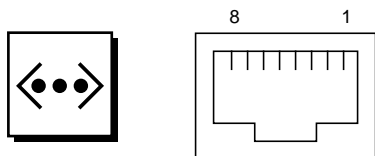

FIGURE 1-6 RJ-45 TPE Connector

TABLE 1-7 TPE Connector Pinouts

Pin	Description	Pin	Description
1	Transmit Data +	5	Common Mode Termination
2	Transmit Data -	6	Receive Data -
3	Receive Data +	7	Common Mode Termination
4	Common Mode Termination	8	Common Mode Termination

1.6.1 TPE Cable-Type Connectivity

The following types of twisted-pair Ethernet cables can be connected to the 8-pin TPE connector:

- For 10BASE-T applications, UTP cable:
 - Category 3 (UTP-3, “voice grade”)
 - Category 4 (UTP-4)
 - Category 5 (UTP-5, “data grade”)
- For 100BASE-T applications, UTP-5, “data grade” cable

1.6.2 External UTP-5 Cable Lengths

TABLE 1-8 TPE UTP-5 Cable Lengths

Cable Type	Application(s)	Maximum Length (Metric)	Maximum Length (English)
UTP-5, "data grade"	10BASE-T	100 meters*	109 yards*
UTP-5, "data grade"	100BASE-T	100 meters*	109 yards*

* IEEE 802.3

1.7 SCSI Connector

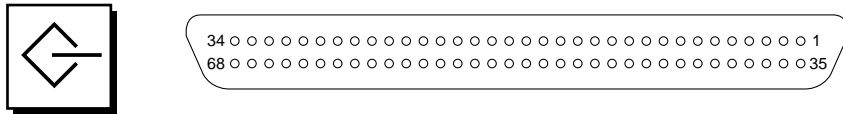

FIGURE 1-7 68-Pin SCSI Connector

TABLE 1-9 68-Pin SCSI Connector Pinouts

Pin	Signal Name	Pin	Signal Name
1	Ground	35	-DB<12>
2	Ground	36	-DB<13>
3	Ground	37	-DB<14>
4	Ground	38	-DB<15>
5	Ground	39	-PAR<1>
6	Ground	40	-DB<0>
7	Ground	41	-DB<1>
8	Ground	42	-DB<2>
9	Ground	43	-DB<3>
10	Ground	44	-DB<4>
11	Ground	45	-DB<5>
12	Ground	46	-DB<6>

TABLE 1-9 68-Pin SCSI Connector Pinouts

Pin	Signal Name	Pin	Signal Name
13	Ground	47	-DB<7>
14	Ground	48	-PAR<0>
15	Ground	49	Ground
16	Ground	50	TERM.DIS
17	TERMPWR	51	TERMPWR
18	TERMPWR	52	TERMPWR
19	Not connected	53	Reserved
20	Ground	54	Ground
21	Ground	55	-ATN
22	Ground	56	Ground
23	Ground	57	-BSY
24	Ground	58	-ACK
25	Ground	59	-RST
26	Ground	60	-MSG
27	Ground	61	-SEL
28	Ground	62	-CD
29	Ground	63	-REQ
30	Ground	64	-IO
31	Ground	65	-DB<8>
32	Ground	66	-DB<9>
33	Ground	67	-DB<10>
34	Ground	68	-DB<11>

Note – All signals shown in TABLE 1-9 are active low.

1.7.1 SCSI Implementation

The Ultra 60 implements a small computer system interface (SCSI) Fast-20 (UltraSCSI) parallel interface bus. The UltraSCSI provides the following:

- Efficient peer-to-peer I/O bus devices

- Mechanical, electrical, and timing specification definition that support transfer rates of 20 or 40 Mbytes per second (corresponding to the data path width of an 8-bit, or 16-bit bus, respectively).
- Peak bandwidth of 40 Mbytes per second (with implemented 16-bit bus width).

The internal SCSI bus is terminated at each end. One set of terminators is located close to the CD-ROM drive connector on the CD-ROM SCSI card. A second set of terminators is located close to the 68-pin external SCSI connector. FIGURE 1-8 shows the SCSI bus configuration.

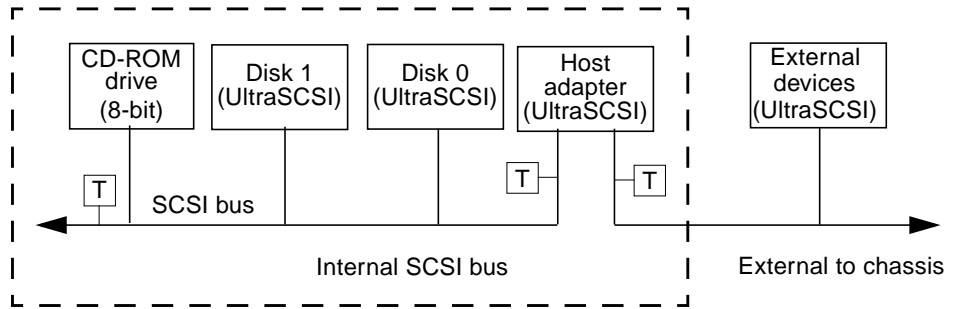

FIGURE 1-8 Configuration for the SCSI Bus

1.7.1.1 Host Adapter

The host adapter is a Symbios Logic PCI-SCSI I/O processor IC. The host adapter and all target devices comply with the Fast-20 single-ended drivers and receivers characteristics. The electrical characteristics of the output buffers include:

- V_{ol} (output low) equals 0 to 0.5 Vdc with I_{ol} at 48 mA (signal asserted)
- V_{oh} (out high) equals 2.5 to 3.7 Vdc (signal negated)
- t_{rise} (rising slew rate) equals 520 mV per nanosecond maximum (0.7 to 2.3 Vdc)
- t_{fall} (falling slew rate) equals 520 mV per nanosecond maximum (2.3 to 0.7 Vdc)

The Fast-20 electrical characteristics for the host adapter and target device include:

- V_{il} (input low) equals 1.0 Vdc maximum (signal true)
- V_{ih} (input high) equals 1.9 Vdc minimum (signal false)
- I_{il} (input low current) equals +/- 20 μ A at V_i equals 0.5 Vdc
- I_{ih} (input high current) equals +/- 20 μ A at V_i equals 2.7 Vdc
- Minimum input hysteresis equals 0.3 Vdc

1.7.1.2 Supported Target Devices

The SCSI subsystem supports a maximum of four internal devices, including the host adapter. The CD-ROM drive is a narrow device. A unipack with one drive or a six-pack, accommodating six drives, can be used as external devices. TABLE 1-10 lists the target devices supported by the SCSI subsystem.

TABLE 1-10 SCSI Target Devices

Target Device	Comment
Internal disks	Up to two 3.5-inch x 1.6-inch disks (4.2, or 9.1-Gbyte). All internal disks are UltraSCSI-compliant.
Internal CD-ROM drive	Optional 644-Mbyte SunCD 12X speed; photo CD compatible. Headphone jack with volume control. CD-ROM drive is a narrow SCSI device.
Internal tape drive(s)	Refer to product guide.
External SPARCstorage UniPack	Refer to product guide.
External SPARCstorage SixPack	.Refer to product guide.

1.7.1.3 External Cables

External UltraSCSI-compliant SCSI cables have an impedance of 90 ohm (+/- 6 ohm) and are required for UltraSCSI interface. Sun's implementation of UltraSCSI requires that the total SCSI bus length be limited to no more than approximately 20 feet (6 meters) with up to 12 Sun compensated devices. Due to the considerably short bus length, an approximate 32-inch (0.8-meter) UltraSCSI-compliant external cable is supported (part number 530-2883) in addition to an approximate 6.5-foot (2-meter) UltraSCSI-compliant external cable (part number 530-2884).

1.7.1.4 Internal SCSI Subassembly

The internal SCSI subassembly consists of two cable assemblies and two SCSI cards. The SCSI subassembly is attached to the motherboard using an insulation displacement connector (IDC) receptacle attached to a 80-conductor cable. In addition to the SCSI signals, the 80-conductor cable carries diskette drive and system LED signals to the SCSI backplane card. The IDC receptacle mates with a right angle plug that is mounted on the motherboard.

The 80-conductor cable attaches on the other end to the SCSI backplane card with another IDC connector. The SCSI backplane card incorporates two SCA-2 connectors for mounting the hard drives, a four-circuit power connector to supply 5 Vdc and 12 Vdc power to the hard drives, a 34-pin diskette drive signal connector, and a green, right-angle LED.

A 68-conductor cable exits the SCSI backplane card, carrying 27 SCSI signals and the Termpower to the internal CD-ROM drive (or tape drive). The SCSI backplane card houses the CD-ROM drive connector and three SCSI bus terminators. The Termpower is routed through the SCSI subassembly to connect to the terminators on the SCSI backplane card in support of the multi-host configuration. FIGURE 1-9 functionally shows the internal SCSI subassembly.

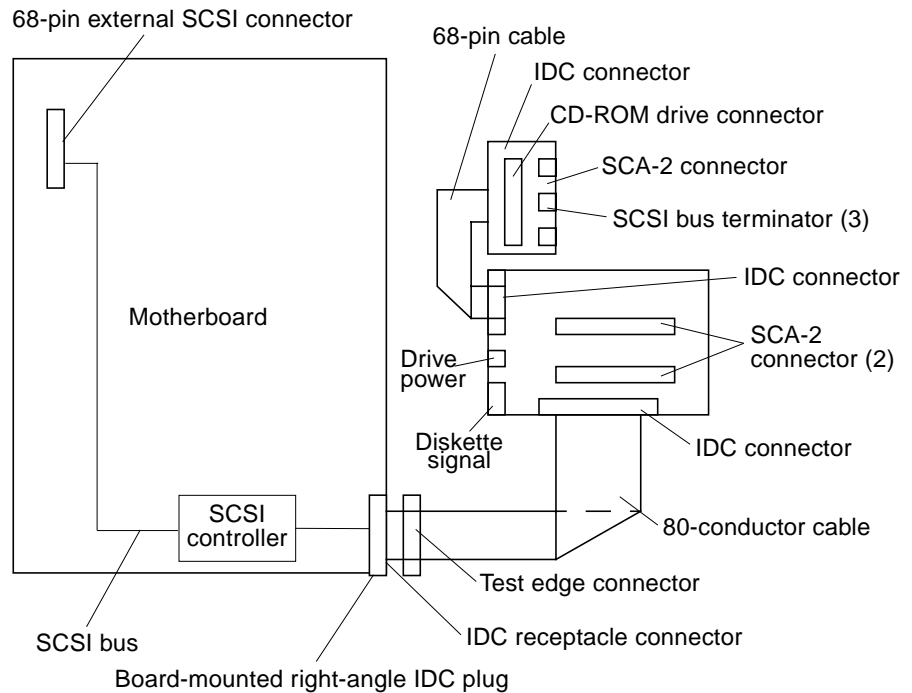

FIGURE 1-9 SCSI Subassembly Functional Block Diagram

1.7.1.5 SCSI ID Selection

The motherboard host adapter is assigned the SCSI identification of 7 for both ports. The two internal drives attached to the SCA-2 connectors have a SCSI identification of 0 and 1, while the CD-ROM has an identification of 6.

1.7.2 SCSI Cabling Procedure

1. Count the number of SCSI devices on the system SCSI bus.

Be sure to count the host adapter as a SCSI device.

2. Determine the total SCSI bus length.

TABLE 1-11 Determining SCSI Bus Length

SCSI Implementation	Bus Width	Data Transfer Rate, Mbytes/s	Number of Devices	SCSI Bus Length
SCSI-2, Fast	8 bits	10	1-8	6.0 meters
SCSI-2, Fast/Wide	16 bits	20	1-8	6.0 meters
SCSI-3 Parallel Interface, Fast-20 Wide (UltraSCSI) (WideUltra)	16 bits	40	1-4	3.0 meters ²
SCSI-3 Parallel Interface, Fast-20 Wide (UltraSCSI) (WideUltra)	16 bits	40	5-8 ¹	1.5 meters ²

1. The maximum number of single-ended/differential SCSI devices is 16.

2. The effective internal SCSI bus length of the Ultra 60 system unit is 0.9 meter.

3. Verify the cable type used to connect external SCSI devices.

You must use Fast-20 SCSI cable(s).

4. Ensure that the total SCSI cable length does not exceed the permissible total SCSI bus length.

An Ultra 60 system enables the use of a single 0.8 meter (32 inch) Fast-20 SCSI cable to a single external SCSI-3 parallel interface, Fast-20 Wide (UltraSCSI, WideUltra) device or device cluster.

1.7.3 SCSI-2 (Fast/Wide SCSI) External Devices

If you connect SCSI-2 (Fast/Wide SCSI, 20 Mbytes data transfer rate) external devices to an Ultra 60 system, follow these cabling and configuration guidelines to ensure proper device addressing and operation:

- If all external mass storage devices use 68-pin connectors, connect all non-Sun devices to the Ultra 60 system first and follow them with Sun devices. Sun devices use autotermination.
- If external mass storage devices consist of 68-pin Sun devices and 50-pin devices, connect the Sun 68-pin devices to the Ultra 60 system first and terminate the daisy chain with the 50-pin device and its terminator.
- The total SCSI bus length for all SCSI devices (internal and external) is 6.0 meters (19.7 feet).

See FIGURE 1-10 for a summary of cabling and configuration guidelines.

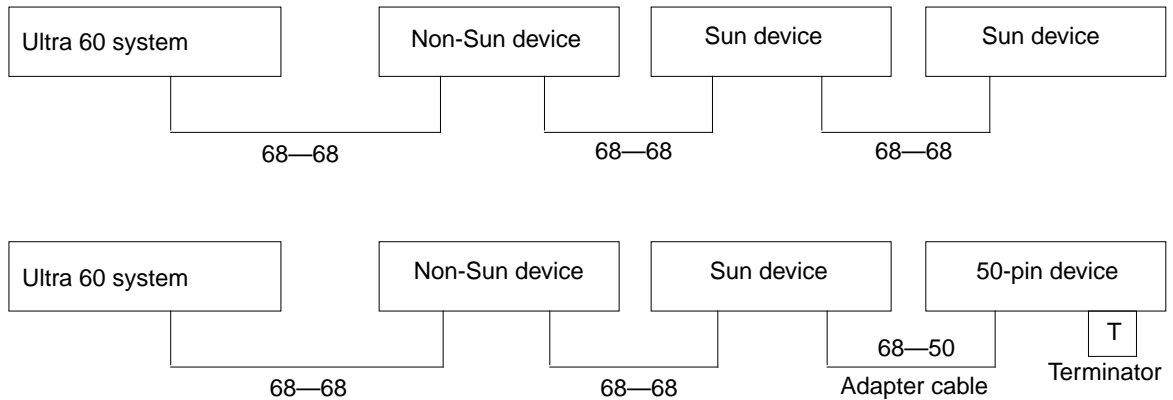

FIGURE 1-10 Connecting External Mass Storage Devices

1.8 Audio Ports

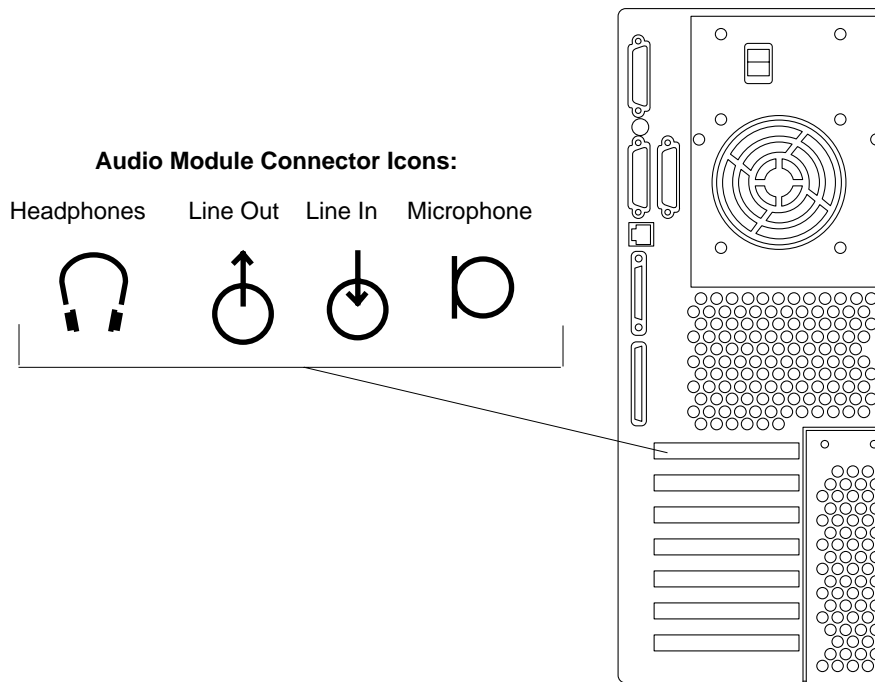

FIGURE 1-11 Audio Port Locations

All audio ports use EIA standard 3.5-mm/0.125-inch jacks.

TABLE 1-12 Audio Port Signals

Plug	Headphones	Line Out	Line In	Microphone
Tip	Left Channel	Left Channel	Left Channel	Left Channel
Ring (Center)	Right Channel	Right Channel	Right Channel	Right Channel
Shield	Ground	Ground	Ground	Ground

TABLE 1-13 Audio Port Functions

Port	Function
Headphones	Connects stereophonic headphones for private listening of audio output
Line Out	Connects the system audio output to an external stereophonic amplifier
Line In	Connects external stereophonic audio sources such as a compact disc player or cassette tape player to the system
Microphone	Connects the SunMicrophone™ II (or other suitable microphone ¹) to the system

1. The Ultra 60 system microphone port accepts stereophonic input; however, the Sun Microphone II is a monophonic device. Note also that the older SunMicrophone is not compatible with the Ultra 60 system.

1.9 Audio Specifications

The microphone input specifications are designed for the SunMicrophone II or equivalent.

TABLE 1-14 Audio Inputs and Output

Stereo I/Os	Specifications
Line In	3.3V peak (nominal), 9.2 k Ω input impedance
Frequency Response	20 Hz-17 kHz +/- 1 dB
Microphone Input	35 mV peak (nominal), 2.21 k Ω input impedance
Headphones Output	0.84V peak (nominal), 9 Ω output impedance; headphone impedance may vary from 9 Ω to 1 k Ω
Line Out	1.4V peak (nominal), 220 Ω output impedance

TABLE 1-15 Internal Monaural Speaker Specifications

Speaker	Specifications
Power Output	1W average, 2W peak
Distortion	0.02%, typical at 1 kHz
Impedance	16 Ω +/- 15%
Frequency Response	170 Hz-20 kHz +/- 6 dB

1.10 Graphics Card 13W3 Video Connector

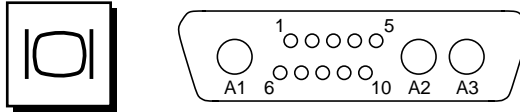

FIGURE 1-12 13W3 Video Connector

The graphics card for your system provides the 13W3 video connector for transmitting video output signals from the system unit to the monitor.

TABLE 1-16 13W3 Video Connector Pinouts

Pin	Function	I/O	Level
A1	Red	O	Analog
A2	Green	O	Analog
A3	Blue	O	Analog
1	Serial Read		TTL
2	Vert Sync	O	TTL
3	Sense <0>	I	TTL
4	Ground		GND
5	Comp Sync	O	TTL
6	Horiz Sync	O	TTL
7	Serial Write		TTL
8	Sense <1>	I	TTL
9	Sense <2>	I	TTL
10	Ground		GND

Modem Setup Specifications

2.1 Setting Up the Modem

Any modem compatible with CCITT V.24 can be connected to the Ultra 60 serial ports. Modems can be set up to function in one of three ways:

- Dial out only
- Dial in only
- Bidirectional calls

To set up your modem:

1. **Become superuser and type `admintool`.**

```
% su
Password:
# admintool
```

2. **Click Serial Port Manager.**
3. **Select Port a or Port b for your modem connection.**
4. **Click Edit.**

The Serial Port Manager: Modify Service window is displayed.
5. **Choose the Expert level of detail.**
6. **From the Use Template menu, choose one of the following:**
 - Modem - Dial-Out only
 - Modem - Dial-In Only
 - Modem - Bidirectional
7. **Click Apply.**

8. Set your modem auto-answer switch to one of the following:

- Off – Dial-Out Only
- On – Dial-In Only
- On – Bidirectional

2.2 Serial Port Speed Change

To change the speed of a serial port, you must edit the `/etc/remote` file as follows:

1. Become superuser, and type `cd /etc`.

```
% su
Password:
# cd /etc
```

2. Type `vi remote`.

3. Type `tip speed device-name`.

Typical speeds are 9600, 19200 to 38400 bps*.

The device name is the serial port name — for example,
`/dev/tty[a,b]` or `/dev/term/[a,b]`.

Note – *The Ultra 60 serial ports are tested to a maximum of 460,000 bps. As of March 1997, Ultra 60 systems have not been tested with 56,000 bps V.34 modems.

4. Press Esc and type `:wq` to save your file change(s) and to exit from the `vi` text editor.

2.3 Recommendations

2.3.1 Cable

For a modem-to-host (system) connection, use an RS-423/RS-232 straight-through cable with DB-25 male connectors at both ends.

2.3.2 Modem Switch Settings (AT Commands)

These settings are guidelines to help you get started quickly. They may change depending on your site requirements and the modem you are using.

- Enable transmit flow control (AT&H1) [suggested setting]
(Required for sending binary/8-bit data.)
- Set link rate to fixed
(Will not track modem data rate, AT&Bn; n = menu choice in modem manual.)
- Set display result codes (ATQ0)
- Set verbal result codes (ATV1)
- Set result code subset (ATXn; n = option choice)
- Save settings in NVRAM (AT&W)

For additional information about modem switch settings, refer to the manual that came with your modem.

Motherboard Jumpers

The jumper settings in this chapter refer to the etchings on the motherboard. The jumpers are labeled with the letter “J” followed by a four-digit number (for example, J2702).

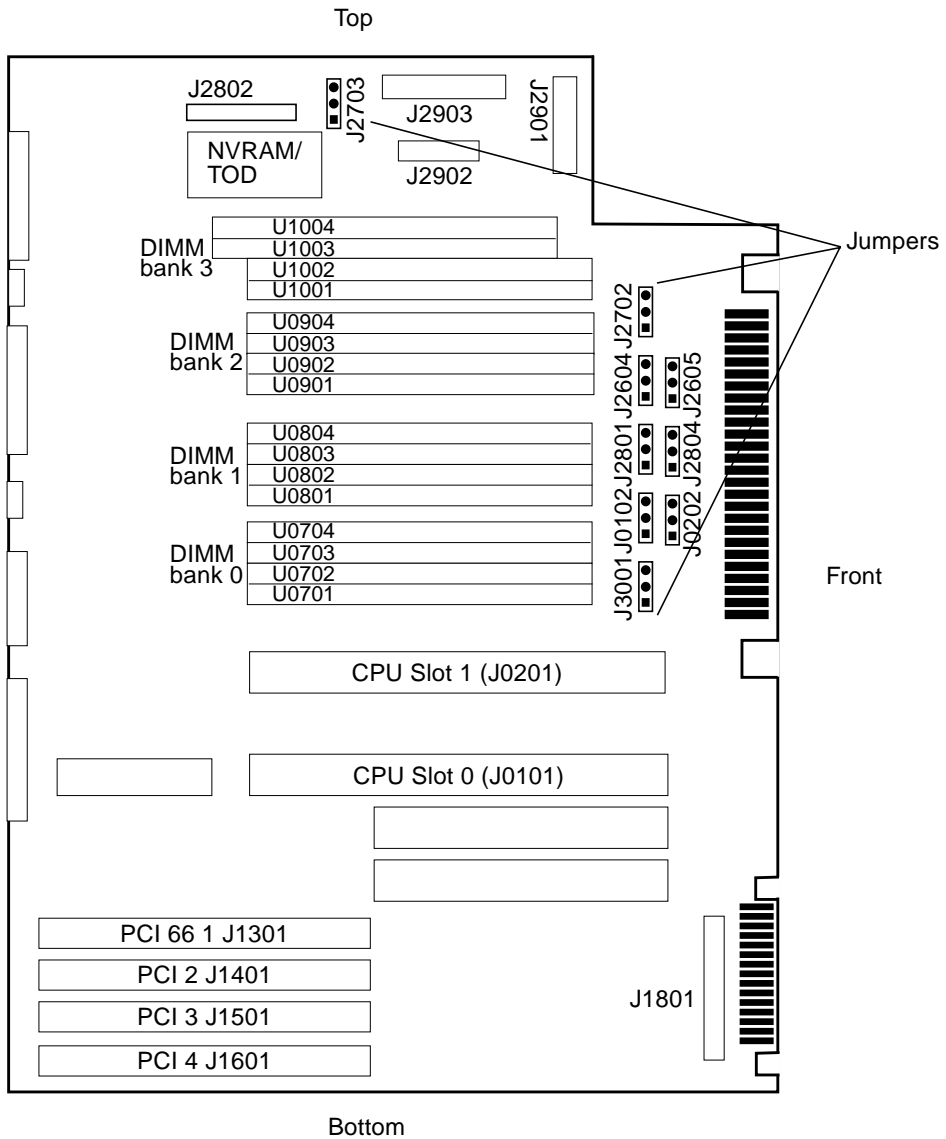

FIGURE 3-1 Jumper Locations on the Motherboard

3.1 Identifying Jumpers

Jumpers are marked on the motherboard with part numbers. For example, the serial port jumpers are marked J2604 and J2605. Jumper pins are located immediately adjacent to the part number. Pin 1 is marked with an asterisk in the position shown in FIGURE 3-2.

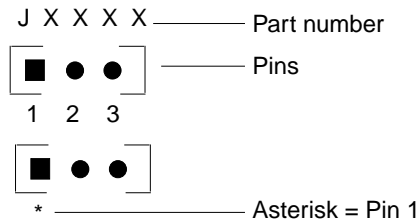

FIGURE 3-2 Identifying Jumper Pins

TABLE 3-1 User-Configurable Jumpers

Jumper	Functionality
J2703	Flash PROM write protect/write enable
J2605	Serial ports B & A RS-423/RS-232
J2604	
J2804	Flash PROM boot control

3.2 Flash PROM Jumpers

The Ultra 60 system uses flash PROMs (programmable read-only memory). Flash PROMs enable:

- Reprogramming of specific code blocks
- Remote reprogramming of the PROM chip by a system administrator over a local area network

The default shunt setting of J2703 is on pins 1 and 2 (write protect). This disables the flash PROM chip from being reprogrammed. Placing the shunt on pins 2 and 3 (write enable) enables reprogramming of the flash PROM chip.

Note – After reprogramming your system flash PROM, make sure you return the flash PROM write protect/enable jumper (J2703) to the write protect position to increase system security.

TABLE 3-2 Flash PROM Jumper Settings

Jumper	Pins 1 + 2 Select	Pins 2 + 3 Select	Default Jumper on Pins	Name
J2703	Write protect	Write enable	1 + 2	Write protect/ write enable
J2804	High half booting	Normal booting	2 + 3	Boot control

3.3 Serial Port Jumpers

The serial port jumpers on the motherboard enable you to configure the two DB-25 serial ports on the system unit back panel for either RS-423 or RS-232 signal levels. RS-423 levels are the default standard for North American users. RS-232 levels are required for telecommunication in nations of the European Community.

TABLE 3-3 Serial Port Jumper Settings

Jumper	Pins 1 + 2 Select	Pins 2 + 3 Select	Default Jumper on Pins	Signal Controlled
J2604	RS-232	RS-423	2 + 3	RS232/RS423 SEL
J2605	RS-232	RS-423	2 + 3	RS232/RS423 SEL

System Specifications

4.1 Power Specifications

TABLE 4-1 Power Specifications

Input/Output	Specifications
AC power input	100–240 volts AC nominal, 47–63 Hz
DC power output	350 watts maximum

TABLE 4-2 Power Supply Outputs

Output	DC Voltage (Volts)	Maximum Current (Amperes)	Voltage Regulation Range
1*	3.3	60	3.23 to 3.43
2	5	30	4.85 to 5.25
3*	12	6	11.65 to 12.60
4	-12	0.4	-12.6 to -11.4
5	2.5–3.5	25	+/-2%

* The combined power of outputs 1 and 3 must be less than 300 watts.

4.2 Environmental Specifications

The specifications in TABLE 4-3 comply with the *International Electrotechnical Commission (IEC) Standards*, 5th ed., 1990–1994.

TABLE 4-3 Environmental Specifications: Operating

Parameter	Specification	Standard
Altitude	0 meters (0 feet) [sea level] to 3000 meters (9840 feet)	IEC 68-2-13
Humidity	20% to 80% relative humidity (RH), wet bulb limit of 27°C	IEC 68-2-02, 68-2-03
Shock	5.0G, 11 milliseconds, half sine pulse	IEC 68-2-27
Vibration	0.2G, 5 to 500 to 5 Hz, 5 sweeps in 3 mutually perpendicular axes	IEC 68-2-06
Temperature without removable tape media	10°C to 40°C (50°F to 104°F)	IEC 68-2-01, 68-2-02
Temperature with removable tape media	10°C to 35°C (50°F to 95°F)	IEC 68-2-01, 68-2-02

TABLE 4-4 Environmental Specifications: Nonoperating

Parameter	Specification	Standard
Altitude	0 to 12,000 meters (0 to 39,360 feet)	IEC 68-2-13
Humidity	5%-93% relative humidity (RH) at 40°C (104°F)	IEC 68-2-03
Shock	30G peak, 11 milliseconds, half sine pulse	IEC 68-2-27
Vibration	1.0G, 5 to 500 to 5 Hz, 5 sweeps in 3 mutually perpendicular axes	IEC 68-2-06
Temperature	-20°C to 60°C (-4°F to 140°F)	IEC 68-2-01, 68-2-02

4.3 Physical Specifications

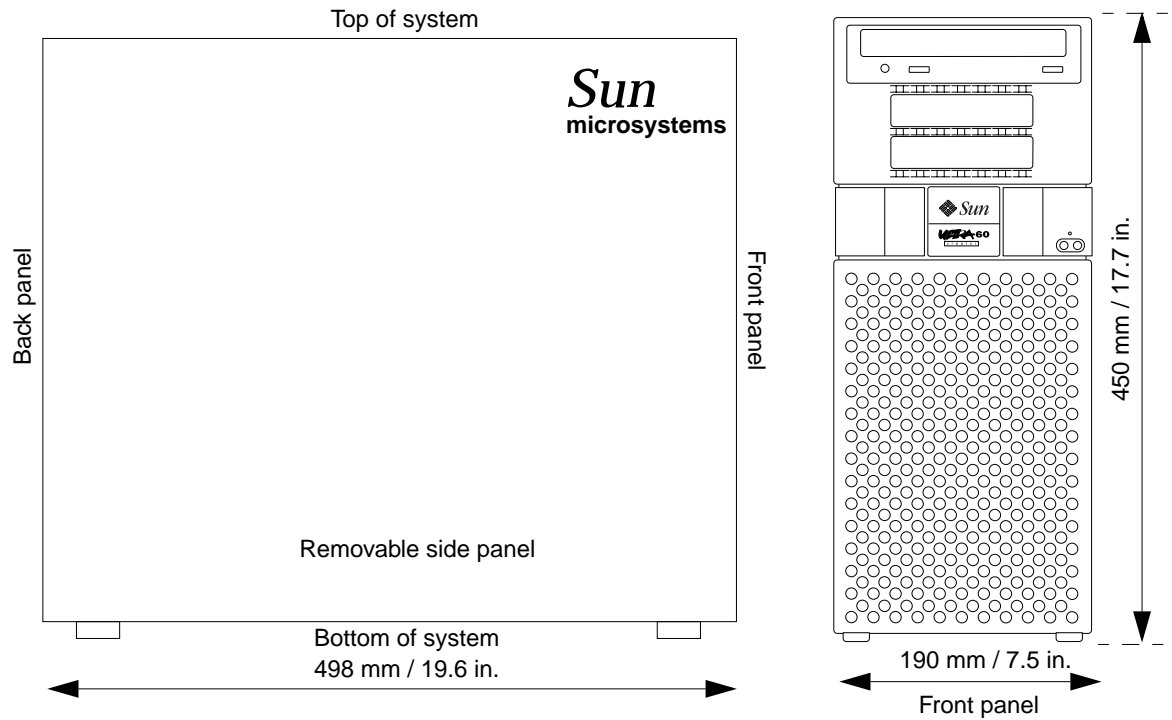

FIGURE 4-1 Ultra 60 System Enclosure Physical Dimensions

TABLE 4-5 Dimensions and Weight

Height	Width	Depth	Weight
450 mm (17.7 in.)	190 mm (7.5 in.)	498 mm (19.6 in.)	18.1 kg (39.9 lb)*

*This weight is an approximation for a system equipped with four dual in-line memory modules (DIMMs), two CPU modules, two UPA graphics cards, and one hard disk drive.

4.4 Memory Mapping

4.4.1 DIMM Installation Guidelines

- Ultra 60 dual in-line memory modules (DIMMs) are installed and mapped in banks of four DIMMs.
- DIMM sizes of 16-, 32-, 64-, and 128-Mbytes are supported. Therefore, the minimum capacity for a bank of four DIMMs is 64 Mbytes and the maximum capacity is 512 Mbytes.
- You must install each bank with four DIMMs of the same memory size and speed.
- If DIMMs of different memory size are installed together in a bank of four, the system might not function properly.
- A minimum of four DIMMs must be installed in a bank of four slots in order for the system to boot.

4.4.2 DIMM Banks and Slots

TABLE 4-6 lists the DIMM banks and slots, and FIGURE 4-2 shows the banks on the motherboard.

Bank 3 (the bank closest to the top of the system) is the default location for the four factory-installed DIMMs.

TABLE 4-6 DIMM Banks and Slots

Bank	Slots
3	U1001, U1002, U1003, U1004
2	U0901, U0902, U0903, U0904
1	U0801, U0802, U0803, U0804
0	U0701, U0702, U0703, U0704

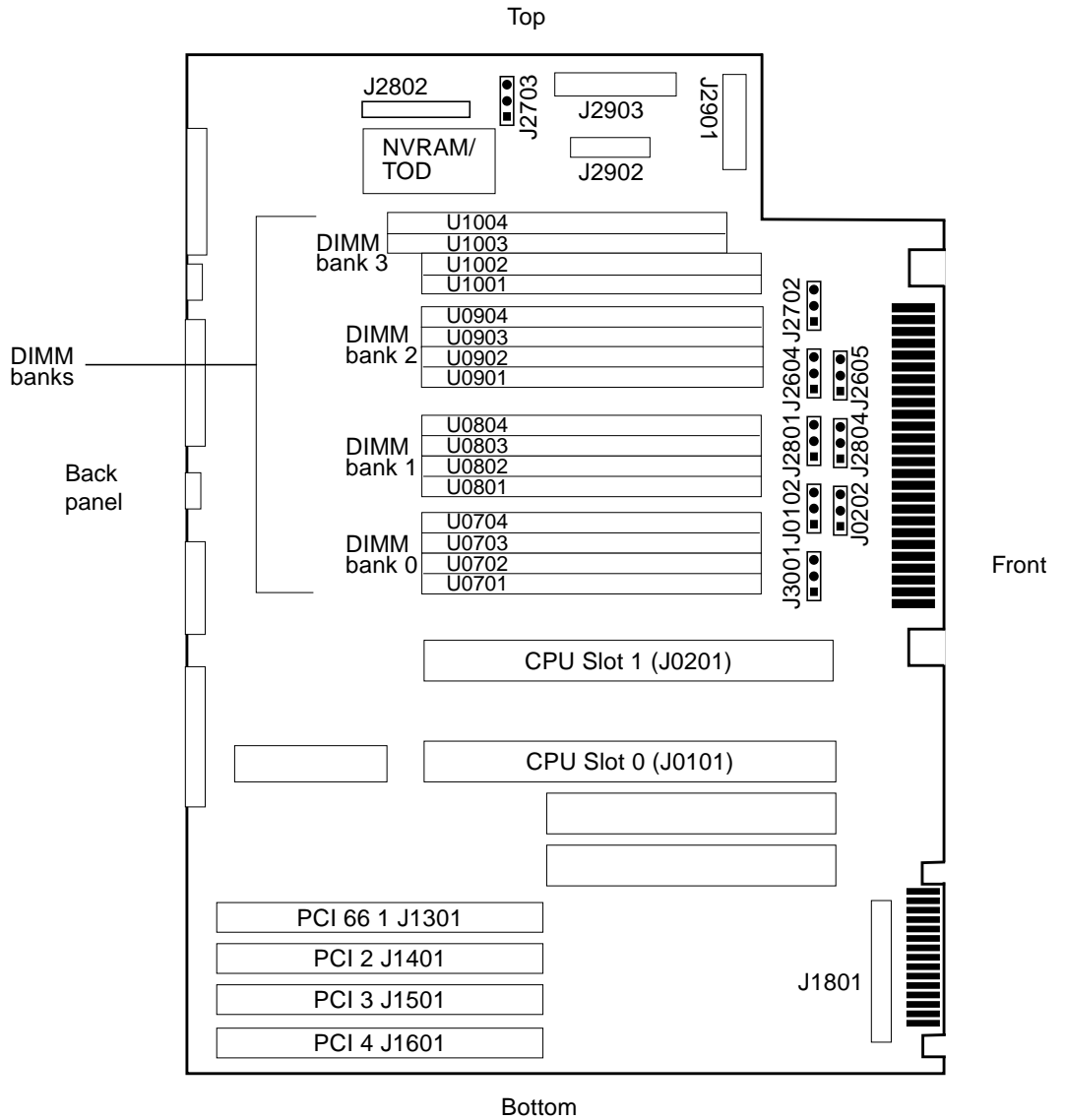

FIGURE 4-2 Map of DIMM Banks and Slots on Motherboard

4.5 PCI Card Slot Specifications

The Ultra 60 system uses the peripheral component interconnect (PCI) local bus architecture to connect PCI accessory cards (printed circuit boards). PCI cards plug into Ultra 60 system PCI slots. PCI cards come in different physical sizes, operate at different frequencies, and provide many different types of functionality.

4.5.1 Locating the PCI Card Slots

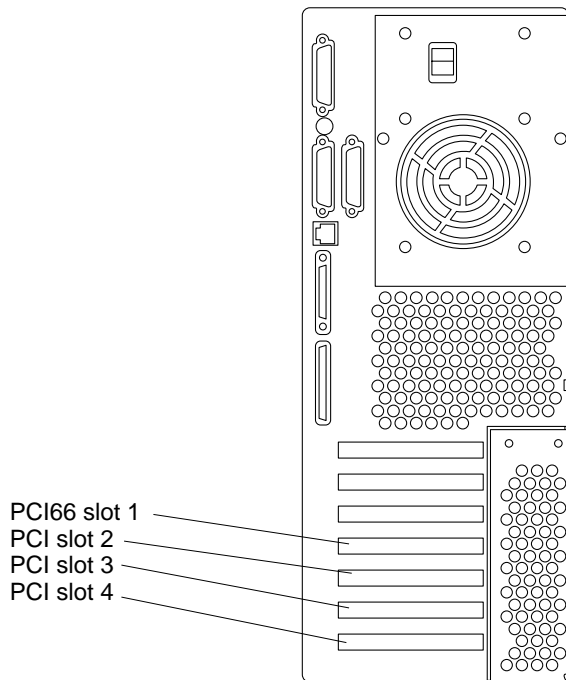

FIGURE 4-3 PCI Card Slot Locations on the System Unit Back Panel

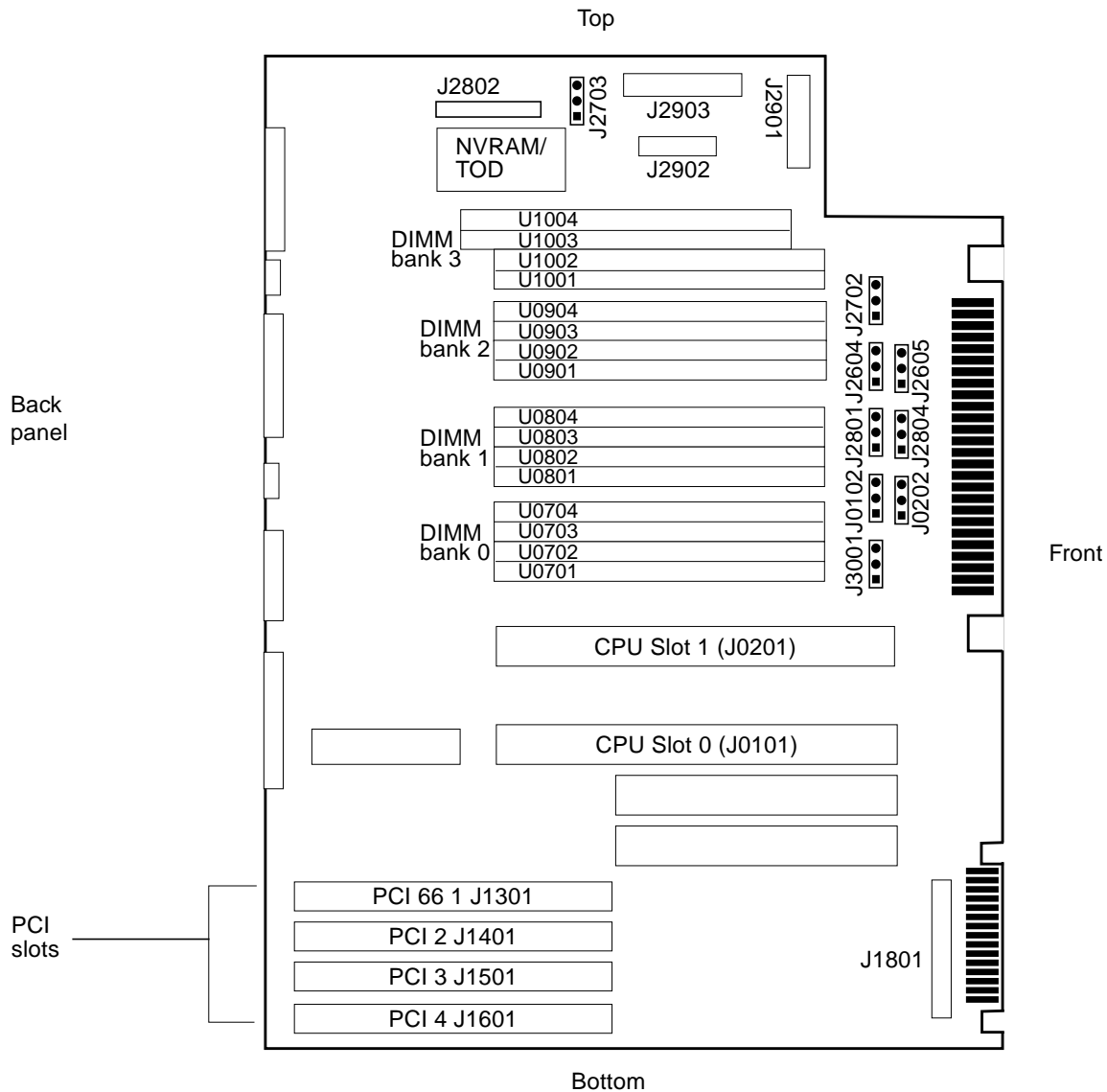

FIGURE 4-4 PCI Card Slot Locations on the Motherboard

4.5.2 PCI Card Slot Operating Frequencies

TABLE 4-7 PCI Card Slot Operating Frequencies

PCI Card Slot	Operating Frequency or Frequencies	Input/Output Signaling Level
PCI66 Slot 1 (J1301)	66 MHz	3.3 volts
	33 MHz	3.3 volts
PCI Slot 2 (J1401)	33 MHz	5.0 volts
PCI Slot 3 (J1501)	33 MHz	5.0 volts
PCI Slot 4 (J1601)	33 MHz	5.0 volts

- All Ultra 60 system PCI card slots operate at 32-bit or 64-bit bus widths.
- Most PCI cards operate at 33 MHz.
- Cards designed to operate at 66 MHz must be installed in the PCI66 slot.

Note – If you install a 33 MHz PCI card in PCI66 slot 1, refer to the card manufacturer's documentation and verify that the card will operate with an I/O signaling level of 3.3 volts.
