

# Sun Ultra 2 Series Reference Manual

---



THE NETWORK IS THE COMPUTER™

**Sun Microsystems Computer Company**  
**A Sun Microsystems, Inc. Business**  
901 San Antonio Road Palo Alto, CA 94303-4900 USA  
650 960-1300  
fax 650 969-9131

Part No.: 802-2562-11  
Revision A, May 1996

1997 Sun Microsystems, Inc., 901 San Antonio Road, Palo Alto, California 94303-4900 U.S.A.

All rights reserved.

This product or document is protected by copyright and distributed under licenses restricting its use, copying, distribution, and decompilation. No part of this product or document may be reproduced in any form by any means without prior written authorization of Sun and its licensors, if any.

Portions of this product may be derived from the UNIX® system, licensed from Novell, Inc., and from the Berkeley 4.3 BSD system, licensed from the University of California. UNIX is a registered trademark in the United States and in other countries and is exclusively licensed by X/Open Company Ltd. Third-party software, including font technology in this product, is protected by copyright and licensed from Sun's suppliers. RESTRICTED RIGHTS: Use, duplication, or disclosure by the U.S. Government is subject to restrictions of FAR 52.227-14(g)(2)(6/87) and FAR 52.227-19(6/87), or DFAR 252.227-7015(b)(6/95) and DFAR 227.7202-3(a).

Sun, Sun Microsystems, the Sun logo, and Solaris are trademarks or registered trademarks of Sun Microsystems, Inc. in the United States and in other countries. All SPARC trademarks are used under license and are trademarks or registered trademarks of SPARC International, Inc. in the United States and in other countries. Products bearing SPARC trademarks are based upon an architecture developed by Sun Microsystems, Inc.

The OPEN LOOK® and Sun™ Graphical User Interfaces were developed by Sun Microsystems, Inc. for its users and licensees. Sun acknowledges the pioneering efforts of Xerox Corporation in researching and developing the concept of visual or graphical user interfaces for the computer industry. Sun holds a nonexclusive license from Xerox to the Xerox Graphical User Interface, which license also covers Sun's licensees who implement OPEN LOOK GUIs and otherwise comply with Sun's written license agreements.

THIS PUBLICATION IS PROVIDED "AS IS" WITHOUT WARRANTY OF ANY KIND, EITHER EXPRESS OR IMPLIED, INCLUDING, BUT NOT LIMITED TO, THE IMPLIED WARRANTIES OF MERCHANTABILITY, FITNESS FOR A PARTICULAR PURPOSE, OR NON-INFRINGEMENT.

Copyright 1997 Sun Microsystems, Inc., 901 San Antonio Road, Palo Alto, Californie 94303-4900 U.S.A. Tous droits réservés.

Ce produit ou document est protégé par un copyright et distribué avec des licences qui en restreignent l'utilisation, la copie et la décompilation. Aucune partie de ce produit ou de sa documentation associée ne peut être reproduite sous aucune forme, par quelque moyen que ce soit, sans l'autorisation préalable et écrite de Sun et de ses bailleurs de licence, s'il y en a.

Des parties de ce produit pourront être dérivées du système UNIX® licencié par Novell, Inc. et du système Berkeley 4.3 BSD licencié par l'Université de Californie. UNIX est une marque enregistrée aux Etats-Unis et dans d'autres pays, et licenciée exclusivement par X/Open Company Ltd. Le logiciel détenu par des tiers, et qui comprend la technologie relative aux polices de caractères, est protégé par un copyright et licencié par des fournisseurs de Sun.

Sun, Sun Microsystems, le logo Sun, et Solaris sont des marques déposées ou enregistrées de Sun Microsystems, Inc. aux Etats-Unis et dans d'autres pays. Toutes les marques SPARC, utilisées sous licence, sont des marques déposées ou enregistrées de SPARC International, Inc. aux Etats-Unis et dans d'autres pays. Les produits portant les marques SPARC sont basés sur une architecture développée par Sun Microsystems, Inc.

Les utilisateurs d'interfaces graphiques OPEN LOOK® et Sun™ ont été développés de Sun Microsystems, Inc. pour ses utilisateurs et licenciés. Sun reconnaît les efforts de pionniers de Xerox Corporation pour la recherche et le développement du concept des interfaces d'utilisation visuelle ou graphique pour l'industrie de l'informatique. Sun détient une licence non exclusive de Xerox sur l'interface d'utilisation graphique, cette licence couvrant aussi les licenciés de Sun qui mettent en place les utilisateurs d'interfaces graphiques OPEN LOOK et qui en outre se conforment aux licences écrites de Sun.

CETTE PUBLICATION EST FOURNIE "EN L'ETAT" SANS GARANTIE D'AUCUNE SORTE, NI EXPRESSE NI IMPLICITE, Y COMPRIS, ET SANS QUE CETTE LISTE NE SOIT LIMITATIVE, DES GARANTIES CONCERNANT LA VALEUR MARCHANDE, L'APTITUDE DES PRODUITS A REpondre A UNE UTILISATION PARTICULIERE OU LE FAIT QU'ILS NE SOIENT PAS CONTREFAISANTS DE PRODUITS DE TIERS.



Adobe PostScript

# Contents

---

**Preface ix**

How This Book Is Organized x

Using UNIX Commands x

Typographic Conventions xi

Shell Prompts xi

Related Books xiii

Sun Documentation on the Web xiii

Sun Welcomes Your Comments xiii

**1. Back Panel Connectors 1-1**

1.1 Connector Layout 1-1

1.2 Serial Connectors 1-3

1.3 Parallel Connector 1-4

1.4 Keyboard/Mouse Connector 1-5

1.5 Media Independent Interface (MII) Connector 1-6

1.6 Twisted-Pair Ethernet (TPE) Connector 1-7

1.7 SCSI Connector 1-8

1.7.1 SCSI Implementation 1-9

1.7.2 SCSI Cabling and Configuration 1-10

1.8 Audio Ports 1-11

- 1.9 Audio Specifications 1-12
- 1.10 Graphics Card 13W3 Video Connector 1-13
  
- 2. 10BASE-T Twisted-Pair Ethernet Link Test 2-1**
  - 2.1 Overview 2-1
  - 2.2 Technical Discussion 2-3
  - 2.3 Troubleshooting 2-4
  - 2.4 Moves and Changes 2-5
  - 2.5 Checking or Disabling the Link Test 2-5
  - 2.6 Enabling the Link Test 2-6
  
- 3. Modem Setup Specifications 3-1**
  - 3.1 Setting Up the Modem 3-1
  - 3.2 Serial Port Speed Change 3-2
  - 3.3 Recommendations 3-2
    - 3.3.1 Cable 3-2
    - 3.3.2 Modem Switch Settings (AT Commands) 3-3
  
- 4. Main Logic Board Jumpers 4-1**
  - 4.1 Identifying Jumpers 4-3
  - 4.2 Flash PROM Jumpers 4-3
  - 4.3 Serial Port Jumpers 4-4
  
- 5. System Specifications 5-1**
  - 5.1 Power 5-1
  - 5.2 Environment 5-2
  - 5.3 Physical Specifications 5-3
  - 5.4 Memory Mapping 5-3

# Figures

---

FIGURE P-1	Ultra 2 Series Nameplates	ix
FIGURE P-2	Ultra Enterprise 2 Nameplate	x
FIGURE 1-1	Back Panel Switches and Connectors	1-2
FIGURE 1-2	DB-25 Serial Connectors	1-3
FIGURE 1-3	DB-25 Parallel Connector	1-4
FIGURE 1-4	DIN-8 Keyboard/Mouse Connector	1-5
FIGURE 1-5	40-Pin Miniature-D MII Connector	1-6
FIGURE 1-6	RJ-45 TPE Connector	1-7
FIGURE 1-7	68-Pin SCSI Connector	1-8
FIGURE 1-8	Connecting External Mass Storage Devices	1-10
FIGURE 1-9	Audio Port Locations	1-11
FIGURE 1-10	13W3 Video Connector	1-13
FIGURE 2-1	Hosts and Hub in a Local Area Network	2-2
FIGURE 2-2	Ensuring Host-Hub Communication in a 10BASE-T Network	2-3
FIGURE 4-1	Jumper Locations on the Main Logic Board	4-2
FIGURE 4-2	Identifying Jumper Pins	4-3



# Tables

---

TABLE P-1	Typographic Conventions	xi
TABLE P-2	Shell Prompts	xi
TABLE P-3	Related Books	xiii
TABLE 1-1	Serial Connector Pinouts, RS-423/RS-232	1-3
TABLE 1-2	Parallel Connector Pinouts	1-4
TABLE 1-3	Keyboard/Mouse Connector Pinouts	1-5
TABLE 1-4	MII Connector Pinouts	1-6
TABLE 1-5	TPE Connector Pinouts	1-7
TABLE 1-6	68-Pin SCSI Connector Pinout	1-8
TABLE 1-7	Audio Port Signals	1-11
TABLE 1-8	Audio Port Functions	1-11
TABLE 1-9	Audio Inputs and Output	1-12
TABLE 1-10	Internal Monaural Speaker Specifications	1-12
TABLE 1-11	13W3 Video Connector Pinouts	1-13
TABLE 4-1	Flash PROM Jumper Settings	4-4
TABLE 4-2	Serial Port Jumper Settings	4-4
TABLE 5-1	Power Specifications	5-1
TABLE 5-2	Environmental Specifications (Operating)	5-2
TABLE 5-3	Environmental Specifications (Nonoperating)	5-2
TABLE 5-4	Dimensions and Weight	5-3

TABLE 5-5 Physical Clearances 5-3

TABLE 5-6 Main Logic Board Memory Mapping 5-3



# Preface

---

The *Sun Ultra 2 Series Reference Manual* contains useful information about the use and maintenance of a Sun™ Ultra™ 2 Series system.

This book is for use with Ultra 2, Ultra 2 Creator, Ultra 2 Creator 3D, and Ultra Enterprise 2 systems only.

The nameplate on your system front panel must be like the nameplate(s) shown in FIGURE P-1 or FIGURE P-2.

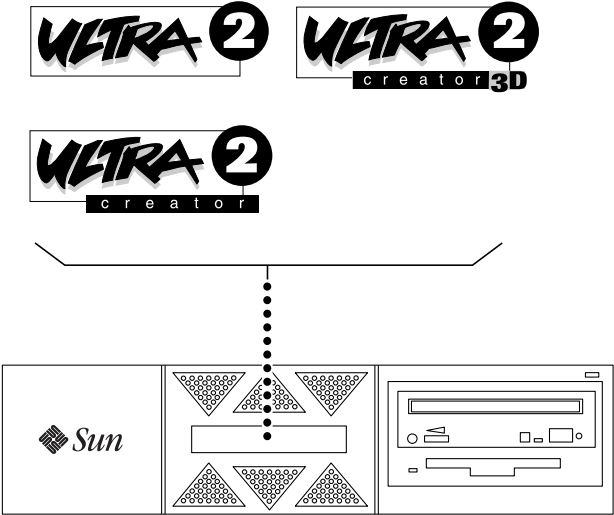

FIGURE P-1 Ultra 2 Series Nameplates

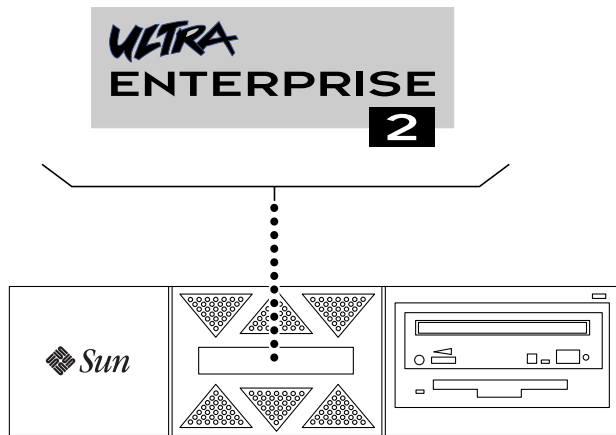

FIGURE P-2 Ultra Enterprise 2 Nameplate

---

## How This Book Is Organized

Chapter 1 provides the location of each back panel connector and gives the pinouts for each connector.

Chapter 2 presents a full tutorial about connecting the system to a 10BASE-T twisted-pair Ethernet (TPE) local area network (LAN).

Chapter 3 gives modem settings for Sun Ultra 2 Series systems used in specific network telecommunication applications.

Chapter 4 gives the locations and pin definitions of user-configurable main-logic board jumpers.

Chapter 5 gives system requirements about power and environment, and also gives system dimension, weight, and memory mapping specifications.

---

## Using UNIX Commands

This document may not contain information on basic UNIX® commands and procedures such as shutting down the system, booting the system, and configuring devices.

See one or more of the following for this information:

- *Solaris 2.x Handbook for SMCC Peripherals* (If you are incorporating Solaris 2.x software commands in your document, delete this sentence.)
- AnswerBook™ online documentation for the Solaris™ 2.x software environment
- Other software documentation that you received with your system

---

## Typographic Conventions

TABLE P-1 Typographic Conventions

Typeface or Symbol	Meaning	Examples
AaBbCc123	The names of commands, files, and directories; on-screen computer output.	Edit your <code>.login</code> file. Use <code>ls -a</code> to list all files. % You have mail.
AaBbCc123	What you type, when contrasted with on-screen computer output.	% <b>su</b> Password:
AaBbCc123	Book titles, new words or terms, words to be emphasized. Command-line variable; replace with a real name or value.	Read Chapter 6 in the <i>User's Guide</i> . These are called <i>class</i> options. You <i>must</i> be <code>root</code> to do this. To delete a file, type <code>rm filename</code> .

---

## Shell Prompts

TABLE P-2 Shell Prompts

Shell	Prompt
C shell	<i>machine_name%</i>

**TABLE P-2** Shell Prompts

<b>Shell</b>	<b>Prompt</b>
C shell superuser	<i>machine_name</i> #
Bourne shell and Korn shell	\$
Bourne shell and Korn shell superuser	#

---

## Related Books

The following documents contain topics that relate to the information in the *Sun Ultra 2 Series Reference Manual*.

**TABLE P-3** Related Books

Application	Title	Part Number
Installation	Sun Ultra 2 Series Hardware Setup Instructions	802-5933
Installation	<i>Sun Ultra 2 Series Installation Guide</i>	802-5934
Service	<i>Sun Ultra 2 Series Service Manual</i>	802-2561

---

## Sun Documentation on the Web

The `docs.sun.com` web site enables you to access Sun technical documentation on the World Wide Web. You can browse the `docs.sun.com` archive or search for a specific book title or subject at:

<http://docs.sun.com>.

---

## Sun Welcomes Your Comments

We are interested in improving our documentation and welcome your comments and suggestions. You can email your comments to us at:

`smcc-docs@sun.com`.

Please include the part number of your document in the subject line of your email.



# Back Panel Connectors

---

---

## 1.1 Connector Layout

See the following figure.

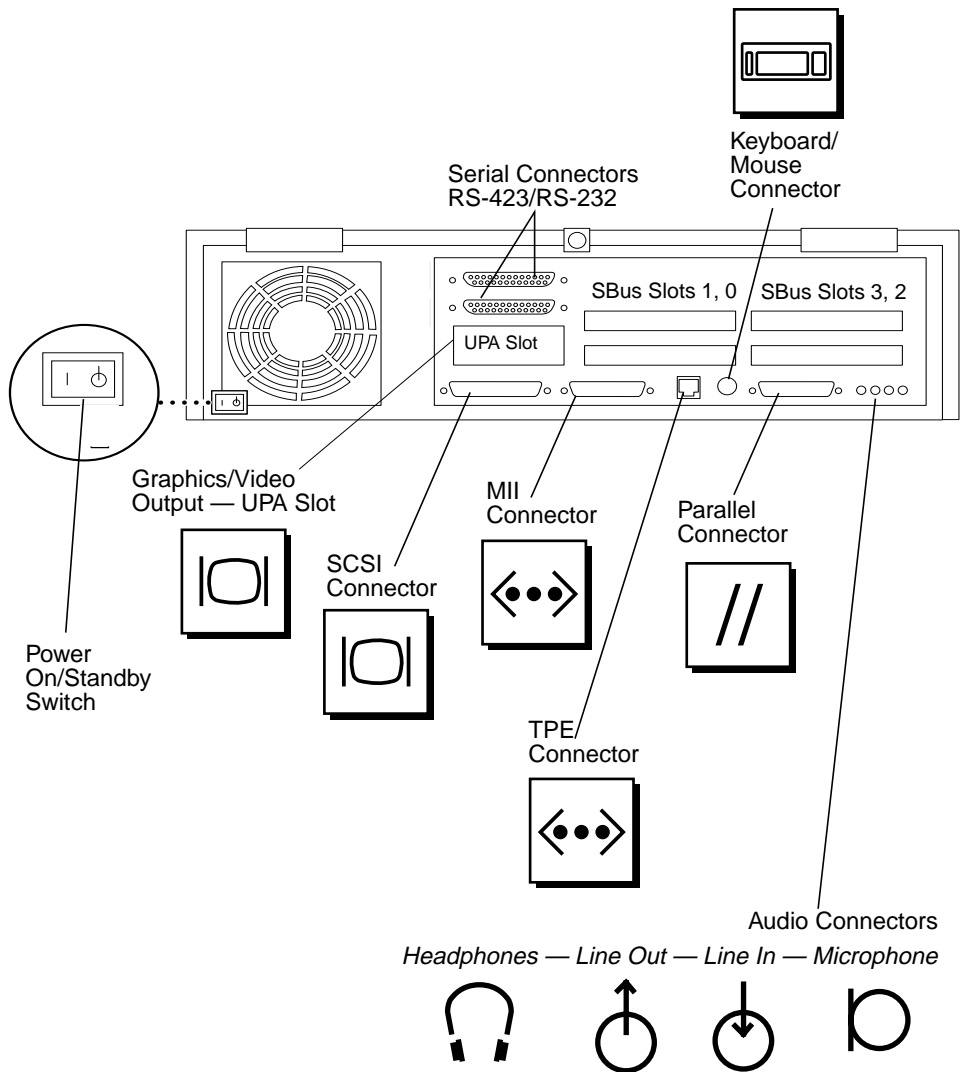

**FIGURE 1-1** Back Panel Switches and Connectors



# 1.2 Serial Connectors

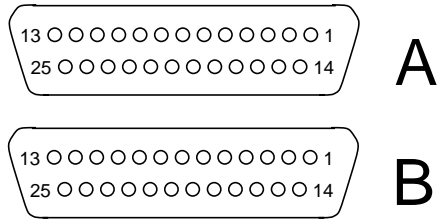

**FIGURE 1-2** DB-25 Serial Connectors

**TABLE 1-1** Serial Connector Pinouts, RS-423/RS-232

Pin	Function	I/O	Signal Description
1	none	none	Not connected
2	TxD	O	Transmit Data
3	RxD	I	Receive Data
4	RTS	O	Ready To Send
5	CTS	I	Clear To Send
6	DSR	I	Data Set Ready
7	Gnd		Signal Ground
8	DCD	I	Data Carrier Detect
9-14	none	none	Not connected
15	TRxC	I	Transmit Clock
16	none	none	Not connected
17	RTxC	I	Receive Clock
18-19	none	none	Not connected
20	DTR	O	Data Terminal Ready
21-23	none	none	Not connected
24	TxC	O	Transmit Clock
25	none	none	Not connected

## 1.3 Parallel Connector

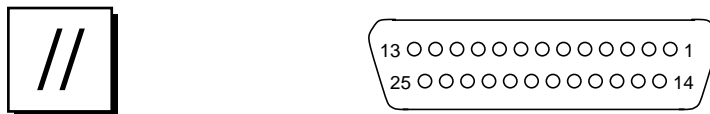

FIGURE 1-3 DB-25 Parallel Connector

TABLE 1-2 Parallel Connector Pinouts

Pin	Description	Pin	Description
1	Data_Strobe_L	14	nAutoFd
2	Data[1]	15	nFault
3	Data[2]	16	nInit
4	Data[3]	17	nSelectIn
5	Data[4]	18	Signal Ground
6	Data[5]	19	Signal Ground
7	Data[6]	20	Signal Ground
8	Data[7]	21	Signal Ground
9	Data[8]	22	Signal Ground
10	nAck	23	Signal Ground
11	Busy	24	Signal Ground
12	PError	25	Signal Ground
13	Select		

---

## 1.4 Keyboard/Mouse Connector

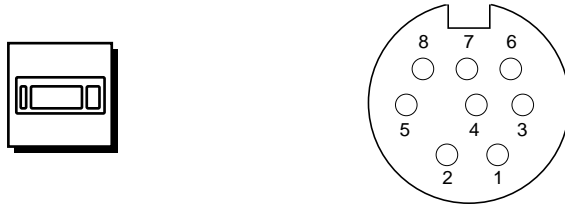

**FIGURE 1-4** DIN-8 Keyboard/Mouse Connector

**TABLE 1-3** Keyboard/Mouse Connector Pinouts

Pin	Description	Pin	Description
1	Ground	5	Keyboard Out
2	Ground	6	Keyboard In
3	+5 VDC	7	Power Key In
4	Mouse In	8	+5 VDC

---

**Note** – All signals are standard TTL levels. The +5V supply is fuse-protected.

---

# 1.5 Media Independent Interface (MII) Connector

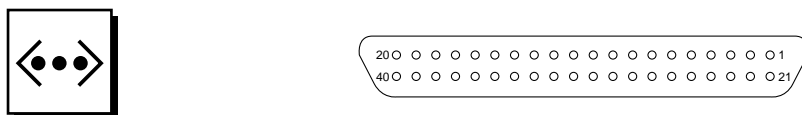

FIGURE 1-5 40-Pin Miniature-D MII Connector

TABLE 1-4 MII Connector Pinouts

Pin	Function	Pin	Function
1	+5V	21	+5V
2	MDIO	22	Signal Ground
3	MDC	23	Signal Ground
4	RXD<3>	24	Signal Ground
5	RXD<2>	25	Signal Ground
6	RXD<1>	26	Signal Ground
7	RXD<0>	27	Signal Ground
8	RX_DV	28	Signal Ground
9	RX_CLK	29	Signal Ground
10	RX_ER	30	Signal Ground
11	TX_ER	31	Signal Ground
12	TX_CLK	32	Signal Ground
13	TX_EN	33	Signal Ground
14	TXD<0>	34	Signal Ground
15	TXD<1>	35	Ground
16	TXD<2>	36	Ground
17	TXD<3>	37	Ground

**TABLE 1-4** MII Connector Pinouts (*Continued*)

Pin	Function	Pin	Function
18	COL	38	Signal Ground
19	CRS	39	Signal Ground
20	+5V	40	+5V

## 1.6 Twisted-Pair Ethernet (TPE) Connector



**FIGURE 1-6** RJ-45 TPE Connector

**TABLE 1-5** TPE Connector Pinouts

Pin	Description	Pin	Description
1	Transmit Data +	5	Common Mode Termination
2	Transmit Data -	6	Receive Data -
3	Receive Data +	7	Common Mode Termination
4	Common Mode Termination	8	Common Mode Termination

## 1.7 SCSI Connector

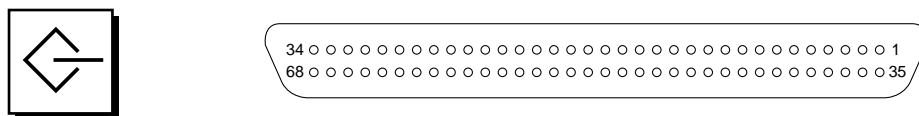

FIGURE 1-7 68-Pin SCSI Connector

TABLE 1-6 68-Pin SCSI Connector Pinout

Pin	Signal Name	Pin	Signal Name
1	Ground	21	Ground
2	Ground	22	Ground
3	Ground	23	Ground
4	Ground	24	Ground
5	Ground	25	Ground
6	Ground	26	Ground
7	Ground	27	Ground
8	Ground	28	Ground
9	Ground	29	Ground
10	Ground	30	Ground
11	Ground	31	Ground
12	Ground	32	Ground
13	Ground	33	Ground
14	Ground	34	Ground
15	Ground	35	-DB<12>
16	Ground	36	-DB<13>
17	TERMPWR	37	-DB<14>
18	TERMPWR	38	-DB<15>
19	Not connected	39	-PAR<1>
20	Ground	40	-DB<0>
41	-DB<1>	63	-REQ
42	-DB<2>	53	Reserved

**TABLE 1-6** 68-Pin SCSI Connector Pinout (*Continued*)

Pin	Signal Name	Pin	Signal Name
43	-DB<3>	54	Ground
44	-DB<4>	55	-ATN
45	-DB<5>	56	Ground
46	-DB<6>	57	-BSY
47	-DB<7>	58	-ACK
48	-PAR<0>	59	-RST
49	Ground	60	-MSG
50	TERM.DIS	64	-IO
51	TERMPWR	65	-DB<8>
52	TERMPWR	66	-DB<9>
61	-SEL	67	-DB<10>
62	-CD	68	-DB<11>

---

**Note** – All signals shown in TABLE 1-6 are active low.

---

## 1.7.1 SCSI Implementation

- Single-ended
- 16-bit (wide SCSI) with parity
- 20 MBytes/sec Fast Wide SCSI
- Supports 16 SCSI addresses:
  - Target 0-6 and 8-F for devices
  - Target 7 reserved for SCSI host adapter on main-logic board
- Supports up to 3 internal SCSI drives:
  - SCSI disk drive target 0 (lower drive slot)
  - SCSI disk drive target 1 (upper drive slot)
  - SCSI CD-ROM drive target 6 *or* SCSI tape drive target 5
- External 8-bit and 16-bit SCSI devices supported via 68-pin SCSI connector

## 1.7.2 SCSI Cabling and Configuration

When mixing 8-bit and 16-bit SCSI devices on the same physical SCSI bus, follow these cabling and configuration guidelines to insure proper device addressing and operation:

- If all external mass storage devices use 68-pin connectors, connect all non-Sun devices to the Ultra 2 Series system first and follow them with Sun devices. Sun devices use autotermination.
- If external mass storage devices consist of 68-pin Sun devices and 50-pin devices, connect the Sun 68-pin devices to the Ultra 2 Series system first and terminate the daisy chain with the 50-pin device and its terminator.

See the following figure for a summary of cabling and configuration guidelines.

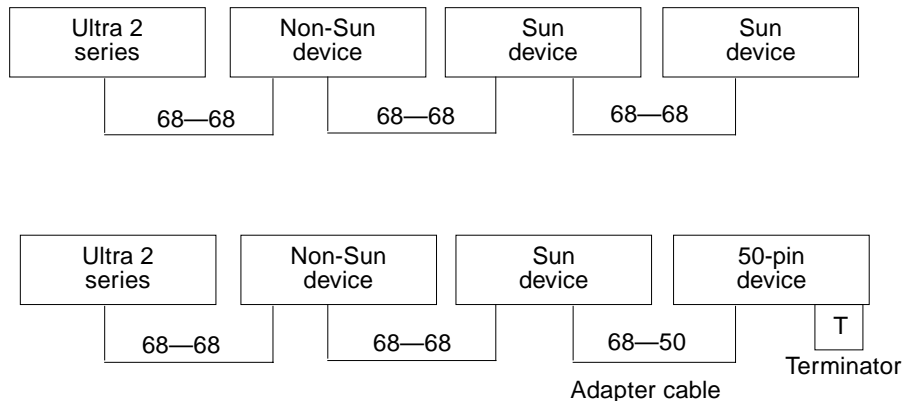

**FIGURE 1-8** Connecting External Mass Storage Devices



# 1.8 Audio Ports

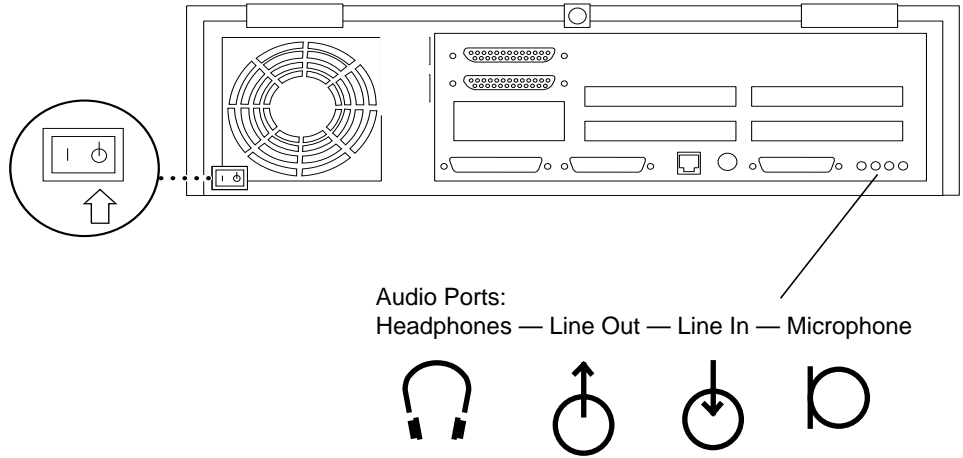

FIGURE 1-9 Audio Port Locations

All audio ports use EIA standard 3.5-mm (0.125-inch) jacks.

TABLE 1-7 Audio Port Signals

	Headphones	Line Out	Line In	Microphone
Tip	Left Channel	Left Channel	Left Channel	Left Channel
Ring (Center)	Right Channel	Right Channel	Right Channel	Right Channel
Shield	Ground	Ground	Ground	Ground

TABLE 1-8 Audio Port Functions

Port	Function
Headphones	Connects stereophonic headphones for private listening of audio output
Line Out	Connects the system audio output to an external stereophonic amplifier and loudspeakers
Line In	Connects external stereophonic audio sources such as a compact disc player or cassette tape player to the system
Microphone	Connects the SunMicrophone II (or other suitable microphone <sup>1</sup> ) to the system

1. The Ultra 2 Series microphone port accepts stereophonic input; however, the Sun Microphone II is a monophonic device. Note also that the older SunMicrophone is not compatible with the Ultra 2 Series system.

## 1.9 Audio Specifications

The specifications in the following table assume use of the Audio Tool format setting “CD-ROM or DAT” selected. TABLE 1-10 lists the internal monaural speaker specifications.

The microphone input specifications are for the SunMicrophone II.

**TABLE 1-9** Audio Inputs and Output

Stereo I/Os	Specifications
Line In	2V typical, 4V max.; 5-50-ohm impedance
Frequency Response	20 Hz-17 kHz +/- 0.5 dB
Internal CD Input	
Input Level	0.1 percent Vrms typical at 10 kohms; 2Vpp max.
Distortion	0.01 percent, typical at 1 kHz
S/N Ratio	84 dB, typical IEC 179 A-weighted
Frequency Response	20 Hz-17 kHz +/- 0.5 dB
Microphone Input	15 mV typical, 0.6-1.0 kohm impedance; +5 VDC input bias via a 2.2 kohms resistor
Headphones Output	1V typical, 2.4V max.; 16 kohms to 1 kohm impedance
Line Out	1V typical, 2.4V max.; 5-50 kohms impedance

**TABLE 1-10** Internal Monaural Speaker Specifications

Speaker	Specifications
Power Output	1.5W ave., 3W peak
Distortion	0.02 percent typical at 1 kHz
Impedance	16 ohms +/- 20 percent
Frequency Response	150 Hz-17 kHz +/- 0.5 dB

---

## 1.10 Graphics Card 13W3 Video Connector



**FIGURE 1-10** 13W3 Video Connector

The graphics card for your system provides the 13W3 video connector for transmitting video output signals from the system unit to the monitor.

See the following table for 13W3 video connector pinouts.

**TABLE 1-11** 13W3 Video Connector Pinouts

Pin	Function	I/O	Level
A1	Red	O	Analog
A2	Green	O	Analog
A3	Blue	O	Analog
1	Serial Read		TTL
2	Vert Sync	O	TTL
3	Sense <0>	I	TTL
4	Ground		GND
5	Comp Sync	O	TTL
6	Horiz Sync	O	TTL
7	Serial Write		TTL
8	Sense <1>	I	TTL
9	Sense <2>	I	TTL
10	Ground		GND



# 10BASE-T Twisted-Pair Ethernet Link Test

---

Read this chapter if you are connecting your Ultra 2 Series system to a 10BASE-T twisted-pair Ethernet (TPE) network. This chapter contains important information for getting your system to communicate correctly over a TPE network. If you have no experience with TPE networks, ask your system or network administrator to perform the procedures in this chapter.

---

**Note** – This chapter does not apply to 100BASE-T networks. In such networks, the link test function must be enabled at both the host and the hub. If your host is connected to a 100BASE-T network, you must not disable the host link test function.

---

---

## 2.1 Overview

- The twisted-pair Ethernet link integrity test is a function defined by the IEEE 802.3 10BASE-T specification.
- For a networked workstation (host) to communicate with a network hub, the link test state (enabled or disabled) must be the same on the host and hub.
- If either the host or hub does not share the link test enabled/disabled state of the other, then the host cannot communicate effectively with the hub, and the hub cannot communicate effectively with the host.

The following figure gives an example of a star configuration local area network (LAN), showing the relationship of hosts to a hub.

FIGURE 2-2 shows the importance of ensuring that the host and hub link test settings match in a 10BASE-T network.

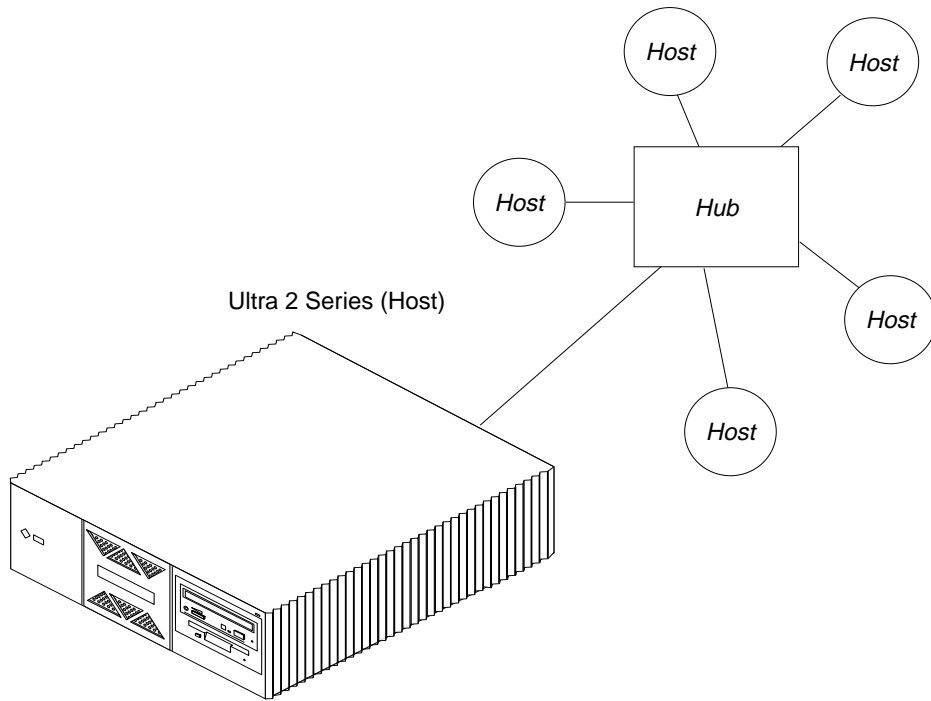

**FIGURE 2-1** Hosts and Hub in a Local Area Network

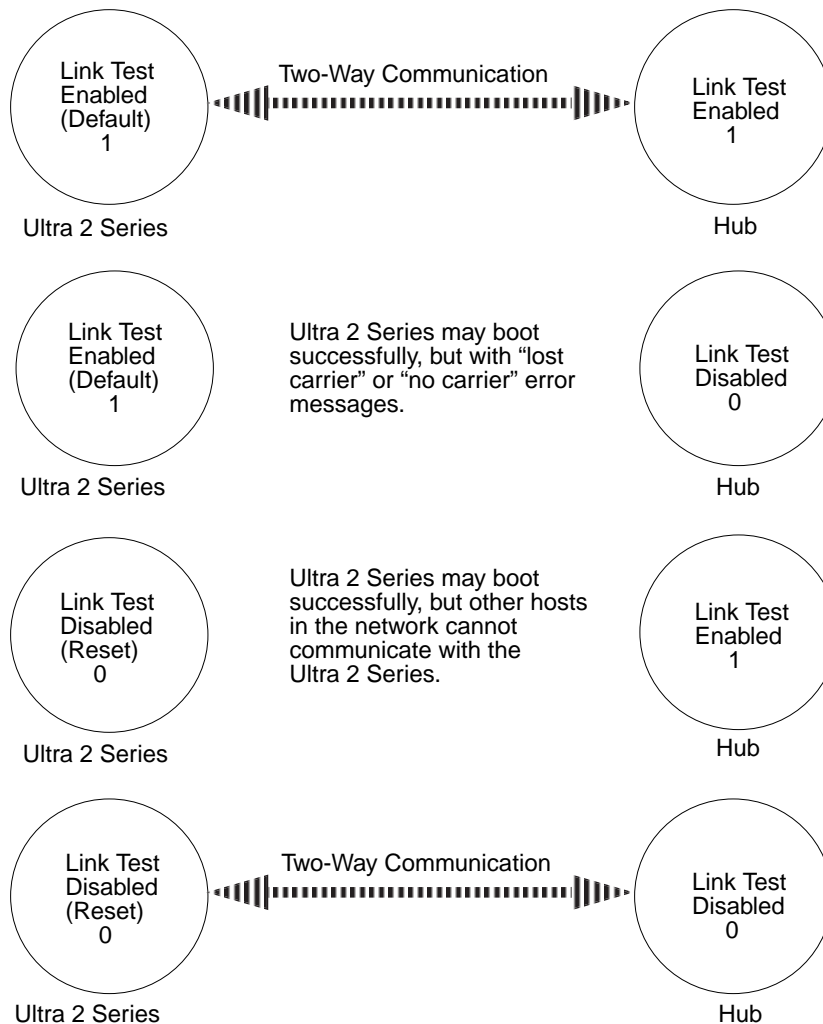

**FIGURE 2-2** Ensuring Host-Hub Communication in a 10BASE-T Network

---

## 2.2 Technical Discussion

The twisted-pair Ethernet link integrity test determines the state of the twisted-pair cable link between the host and the hub in a network. Both the host and hub regularly transmit a link test pulse. When either the host or hub has not received a

link test pulse within a certain amount of time (50-150 ms), it makes the transition from the link-pass state to the link-fail state and remains in the link-fail state until it once again receives regular link test pulses.

The link integrity test is specific to twisted-pair Ethernet and is not applicable to the other physical layer implementations of IEEE 802.3 such as 10BASE5 ("thicknet") or 10BASE2 ("thinnet").

The link test function at the host or hub is either enabled (link test enabled or 1) or disabled (link test disabled or 0). The IEEE 802.3 10BASE-T specification requires that the link test be enabled at both the host and the hub.

Although link test disabled does not conform to the specification, it is often encountered in real-world 10BASE-T network installations. Some hubs from various vendors can exhibit any of the following:

- Link test is "hardwired" enabled—link test is always enabled.
- Link test is "hardwired" disabled—link test is always disabled.
- Link test is configurable—the network administrator may enable or disable link test.

---

## 2.3 Troubleshooting

If you have connected an Ultra 2 Series host to a hub using twisted-pair Ethernet cable and observe either "no carrier" messages or fail to communicate effectively with another host in the same network, look first at the hub. If it supports configurable link test, then make sure "link test enabled" is configured. This is usually done by setting a hardware switch.

If the hub does not support configurable link test, then refer to the hub manufacturer's documentation. Check to see if your hub is hardwired for link test disabled. If it is, you must follow the "Checking or Disabling the Link Test" procedure elsewhere in this chapter to disable the link test at your Ultra 2 Series host.



---

## 2.4 Moves and Changes

If the Ultra 2 Series host is physically moved to another network location or if the hub is reconfigured, remember to refer back to FIGURE 2-2. Unless the new network relationship between the host and the hub is functional (that is, 1-1 link test enabled-link test enabled or 0-0 link test disabled-link test disabled), there will be no full, regular two-way communication between the host and the hub.

---

## 2.5 Checking or Disabling the Link Test

To check the link test state of an Ultra 2 Series host:

1. **If you do not see the `ok` prompt, press the Stop (L1)-a keys.**
2. **At the `ok` prompt, type:**

```
ok printenv tpe-link-test?
tpe-link-test?          true           true
ok
```

The above screen shows the current link test state (true, or enabled), followed by the default state (true, or enabled).

To disable the host's link test function:

1. **Type the following commands:**

```
ok setenv tpe-link-test? false
tpe-link-test? =      false
ok reset-all
```

2. **Boot the host and verify that the transceiver cable problem messages do not appear. Type either `boot net` or `boot disk` and press Return.**

---

## 2.6 Enabling the Link Test

1. If you do not see the `ok` prompt, press the Stop (L1)-a keys.
2. At the `ok` prompt, type:

```
ok printenv tpe-link-test?
tpe-link-test?          false           true
ok
```

The above screen shows the current link test state (false, or disabled), followed by the default state (true, or enabled).

1. To enable the host's link test function, type the following commands:

```
ok setenv tpe-link-test? true
tpe-link-test? =      true
ok reset-all
```

2. Boot the host and verify that the transceiver cable problem messages do not appear. Type either `boot net` or `boot disk` and press Return.

# Modem Setup Specifications

---

---

## 3.1 Setting Up the Modem

Any modem compatible with U.S. Robotics<sup>®</sup> or CCITT V.24 can be connected to the Ultra 2 Series serial ports. Modems can be set up to function in one of three ways:

- Dial out only
- Dial in only
- Bidirectional Calls

To set up your modem:

1. **Become superuser. Type** admintool.

```
% su
Password:
# admintool
```

2. **Highlight** Browse.
3. **Select** Serial Port.
4. **Select Port A or Port B for your modem connection.**
5. **Select** Edit.
6. **Select** Expert.
7. **Open the Use Template menu, and select one of the following:**

```
Modem - Dial-Out Only
Modem - Dial-In Only
Modem - Bidirectional
```

8. Select `Apply`.

9. Set your modem auto-answer switch to one of the following:

For Dial-Out Only, set the switch to Off.

For Dial-In Only, set the switch to On.

For Bidirectional, set the switch to On.

---

## 3.2 Serial Port Speed Change

You must edit the `/etc/remote` file to change the speed of a serial port.

1. Become rootsuperuser, and type `cd /etc`.

```
% su
Password:
# cd /etc
```

2. Type `vi remote`.

3. Type `tip speed device-name`.

Typical speeds are 9600, 19200 to 38400 bps.

The device name is the serial port name — for example,

`/dev/tty[a,b]` or `/dev/term/[a,b]`.

4. Press `Esc` and type `:wq` to save your file change(s) and to exit from the `vi` text editor.

---

## 3.3 Recommendations

### 3.3.1 Cable

For a modem-to-host (system) connection, use an RS-423/RS-232 straight-through cable with DB-25 male connectors at both ends.

## 3.3.2 Modem Switch Settings (AT Commands)

- Enable transmit flow control (AT&H1) [suggested setting]  
(Required for sending binary/8-bit data)
- Set link rate to fixed  
(Will not track modem data rate, AT&Bn; n = menu choice in modem manual.)
- Set display result codes (ATQ0)
- Set verbal result codes (ATV1)
- Set result code subset (ATXn; n = option choice)
- Save settings in NVRAM (AT&W)

---

**Note** – The above settings are guidelines to help you get started quickly. Changes to these guidelines should be expected depending on your site requirements and the modem you are using.

---

For additional information about modem switch settings, see the manual that came with your modem.



## Main Logic Board Jumpers

---

Jumper settings given in this chapter refer to etchings on the main logic board. Jumpers are labeled with the letter “J” followed by a four-digit number. See the following figure.

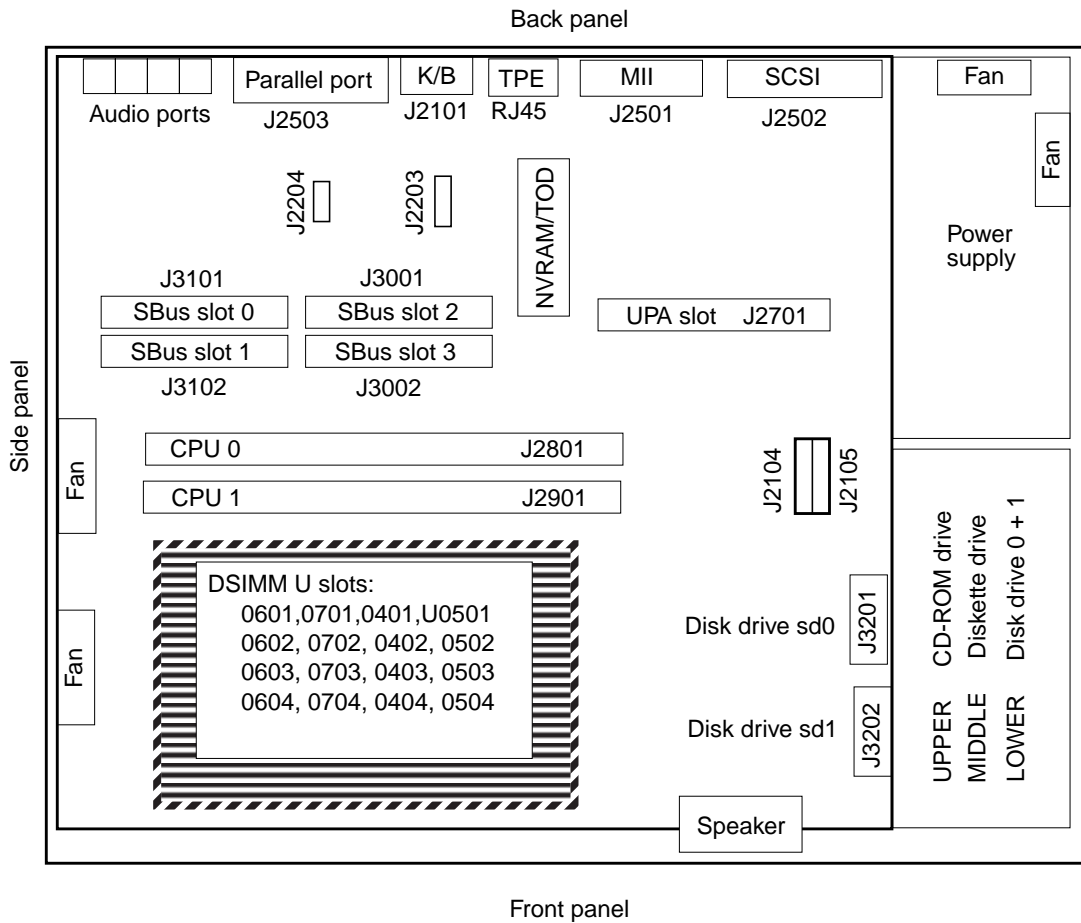

**FIGURE 4-1** Jumper Locations on the Main Logic Board



---

## 4.1 Identifying Jumpers

Jumpers are marked on the main logic board with part numbers. For example, the serial port jumpers are marked J2104 and J2105. Jumper pins are located immediately adjacent to the part number. Pin 1 is marked with an asterisk in any of the positions shown in the following figure.

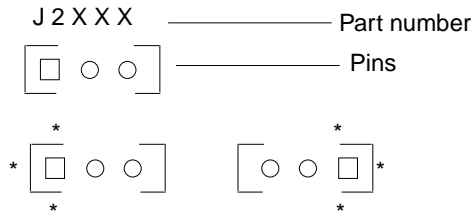

FIGURE 4-2 Identifying Jumper Pins

---

## 4.2 Flash PROM Jumpers

The Ultra 2 Series system uses flash PROMs. Flash PROMs permit the following:

- Reprogramming of specific code blocks
- Remote reprogramming of the PROM chip by a system administrator over a local area network

The default shunt setting of J2002 is on pins 1 and 2. This selects the flash PROM chip as the controlling firmware device. See FIGURE 4-1.

The default shunt setting of J2003 is on pins 1 and 2. This disables the flash PROM chip from being reprogrammed. Placing the shunt on pins 2 and 3 enables reprogramming of the flash PROM chip.

---

**Note** – If you are reprogramming your system flash PROM, after successful reprogramming be sure to return the flash PROM Write Protect/Enable jumper (J2003) to the Write Protect position to increase system security.

---

**TABLE 4-1** Flash PROM Jumper Settings

Jumper	Pins 1 + 2 Select	Pins 2 + 3 Select	Default Jumper on Pins	Signal Controlled
J2002	Flash PROM	Not To Be Used	1 + 2	FLASH PROM SEL
J2003	Write Protect	Write Enable	1 + 2	FLASH PROM PROG ENABLE
J2204	High Half Booting	Normal Booting	2 + 3	XOR LOGIC SET

For flash PROM reprogramming information and the function of J2204, see the *SMCC System Flash PROM Programming Guide*.

---

## 4.3 Serial Port Jumpers

The serial port jumpers on the main logic board permit configuring the two DB-25 serial ports on the system unit back panel for either RS-423 or RS-232 signal levels. RS-423 levels are the default standard for North American users. RS-232 levels are required for digital telecommunication in nations of the European Community.

**TABLE 4-2** Serial Port Jumper Settings

Jumper	Pins 1 + 2 Select	Pins 2 + 3 Select	Default Jumper on Pins	Signal Controlled
J2104	RS-232	RS-423	2 + 3	RS232/RS423 SEL
J2105	RS-232	RS-423	2 + 3	RS232/RS423 SEL

# System Specifications

---

---

## 5.1 Power

The following table lists power specifications.

**TABLE 5-1** Power Specifications

<b>Input/Output</b>	<b>Specifications</b>
AC Power Input	100-240 VAC nominal, 47-63 Hz.
DC Power Output	350 W maximum

## 5.2 Environment

The following specifications comply with the *International Electromechanical Commission (IEC) Standards*, 5th ed., 1990-1994.

**TABLE 5-2** Environmental Specifications (Operating)

<b>Operating</b>	
Altitude without removable tape media	0 meters (0 feet) [sea level], 40 degrees C (104 degrees F) to 3000 meters (9840 feet), 34.6 degrees C (94.2 degrees F) — IEC 68-2-40
Altitude with removable tape media	0 meters (0 feet) [sea level], 35 degrees C (95 degrees F) to 3000 meters (9840 feet), 29.4 degrees C (84.9 degrees F) — IEC 68-2-40
Humidity	5% to 95% relative humidity (RH) regardless of temperature — IEC 68-2-02, 68-2-03
Shock	2.0G, 11 milliseconds, half sine pulse — IEC 68-2-27
Vibration	0.1G, 5 to 500 Hz, swept sine — IEC 68-2-06
Temperature	5 degrees C to 40 degrees C (41 degrees F to 104 degrees F) — IEC 68-2-01, 68-2-02

**TABLE 5-3** Environmental Specifications (Nonoperating)

<b>Nonoperating</b>	
Altitude	0 to 12,000 meters (0 to 39,360 feet) — IEC 68-2-40
Humidity	0% to 93% RH at 40 degrees C (104 degrees F) — IEC 68-2-03
Shock	15 G peak, 11 milliseconds, half sine pulse — IEC 68-2-27
Vibration	0.5 G, 5 to 500 Hz, swept sine — IEC 68-2-06
Temperature	20 degrees C to 55 degrees C (-4 degrees F to 131 degrees F) — IEC 68-2-01, 68-2-0

---

## 5.3 Physical Specifications

**TABLE 5-4** Dimensions and Weight

Height	Width	Depth	Weight
13.0 cm (5.12 in.)	45.0 cm (17.72 in.)	45.2 cm (17.94 in.)	15.88 kg (35.0 lb)

**TABLE 5-5** Physical Clearances

Clearance	Specification
Compact Disc/Diskette	16.51 cm (6.5 in.)
System Unit Parallel Placement	7.6 cm (3.0 in.) <sup>1</sup>

1. Physical space between two system units side by side

---

## 5.4 Memory Mapping

Single in-line memory modules (SIMMs) are installed on the main logic board in groups of four. Identical SIMMs are installed in each group.

**TABLE 5-6** Main Logic Board Memory Mapping

Memory Group	Slots
0	U0501, U0701, U0401, U0601
1	U0502, U0702, U0402, U0602
2	U0503, U0703, U0403, U0603
3	U0504, U0704, U0404, U0604

