

# Sun™ Ultra™ 1 Series to Sun™ Ultra™ 60 System Upgrade Guide

---



THE NETWORK IS THE COMPUTER™

A Sun Microsystems, Inc. Business  
901 San Antonio Road  
Palo Alto, CA 94303 USA  
650 960-1300 fax 650 969-9131

Part No.: 805-1766-10  
Revision A, December 1997

Copyright 1997 Sun Microsystems, Inc., 901 San Antonio Road • Palo Alto, CA 94303 USA. All rights reserved.

This product or document is protected by copyright and distributed under licenses restricting its use, copying, distribution, and decompilation. No part of this product or document may be reproduced in any form by any means without prior written authorization of Sun and its licensors, if any. Third-party software, including font technology, is copyrighted and licensed from Sun suppliers.

Parts of the product may be derived from Berkeley BSD systems, licensed from the University of California. UNIX is a registered trademark in the U.S. and other countries, exclusively licensed through X/Open Company, Ltd.

Sun, Sun Microsystems, the Sun logo, AnswerBook, SunDocs, Ultra, and Solaris are trademarks, registered trademarks, or service marks of Sun Microsystems, Inc. in the U.S. and other countries. All SPARC trademarks are used under license and are trademarks or registered trademarks of SPARC International, Inc. in the U.S. and other countries. Products bearing SPARC trademarks are based upon an architecture developed by Sun Microsystems, Inc.

The OPEN LOOK and Sun™ Graphical User Interface was developed by Sun Microsystems, Inc. for its users and licensees. Sun acknowledges the pioneering efforts of Xerox in researching and developing the concept of visual or graphical user interfaces for the computer industry. Sun holds a non-exclusive license from Xerox to the Xerox Graphical User Interface, which license also covers Sun's licensees who implement OPEN LOOK GUIs and otherwise comply with Sun's written license agreements.

**RESTRICTED RIGHTS:** Use, duplication, or disclosure by the U.S. Government is subject to restrictions of FAR 52.227-14(g)(2)(6/87) and FAR 52.227-19(6/87), or DFAR 252.227-7015(b)(6/95) and DFAR 227.7202-3(a).

DOCUMENTATION IS PROVIDED "AS IS" AND ALL EXPRESS OR IMPLIED CONDITIONS, REPRESENTATIONS AND WARRANTIES, INCLUDING ANY IMPLIED WARRANTY OF MERCHANTABILITY, FITNESS FOR A PARTICULAR PURPOSE OR NON-INFRINGEMENT, ARE DISCLAIMED, EXCEPT TO THE EXTENT THAT SUCH DISCLAIMERS ARE HELD TO BE LEGALLY INVALID.

Copyright 1997 Sun Microsystems, Inc., 901 San Antonio Road • Palo Alto, CA 94303 Etats-Unis. Tous droits réservés.

Ce produit ou document est protégé par un copyright et distribué avec des licences qui en restreignent l'utilisation, la copie, la distribution, et la décompilation. Aucune partie de ce produit ou document ne peut être reproduite sous aucune forme, par quelque moyen que ce soit, sans l'autorisation préalable et écrite de Sun et de ses bailleurs de licence, s'il y en a. Le logiciel détenu par des tiers, et qui comprend la technologie relative aux polices de caractères, est protégé par un copyright et licencié par des fournisseurs de Sun.

Des parties de ce produit pourront être dérivées des systèmes Berkeley BSD licenciés par l'Université de Californie. UNIX est une marque déposée aux Etats-Unis et dans d'autres pays et licenciée exclusivement par X/Open Company, Ltd.

Sun, Sun Microsystems, le logo Sun, AnswerBook, SunDocs, Ultra, et Solaris sont des marques de fabrique ou des marques déposées, ou marques de service, de Sun Microsystems, Inc. aux Etats-Unis et dans d'autres pays. Toutes les marques SPARC sont utilisées sous licence et sont des marques de fabrique ou des marques déposées de SPARC International, Inc. aux Etats-Unis et dans d'autres pays. Les produits portant les marques SPARC sont basés sur une architecture développée par Sun Microsystems, Inc.

L'interface d'utilisation graphique OPEN LOOK et Sun™ a été développée par Sun Microsystems, Inc. pour ses utilisateurs et licenciés. Sun reconnaît les efforts de pionniers de Xerox pour la recherche et le développement du concept des interfaces d'utilisation visuelle ou graphique pour l'industrie de l'informatique. Sun détient une licence non exclusive de Xerox sur l'interface d'utilisation graphique Xerox, cette licence couvrant également les licenciés de Sun qui mettent en place l'interface d'utilisation graphique OPEN LOOK et qui en outre se conforment aux licences écrites de Sun.

CETTE PUBLICATION EST FOURNIE "EN L'ETAT" ET AUCUNE GARANTIE, EXPRESSE OU IMPLICITE, N'EST ACCORDEE, Y COMPRIS DES GARANTIES CONCERNANT LA VALEUR MARCHANDE, L'APTITUDE DE LA PUBLICATION A REpondre A UNE UTILISATION PARTICULIERE, OU LE FAIT QU'ELLE NE SOIT PAS CONTREFAISANTE DE PRODUIT DE TIERS. CE DENI DE GARANTIE NE S'APPLIQUERAIT PAS, DANS LA MESURE OU IL SERAIT TENU JURIDIQUEMENT NUL ET NON AVENU.



Adobe PostScript

## Regulatory Compliance Statements

Your Sun product is marked to indicate its compliance class:

- Federal Communications Commission (FCC) — USA
- Department of Communications (DOC) — Canada
- Voluntary Control Council for Interference (VCCI) — Japan

Please read the appropriate section that corresponds to the marking on your Sun product before attempting to install the product.

### FCC Class A Notice

This device complies with Part 15 of the FCC Rules. Operation is subject to the following two conditions:

1. This device may not cause harmful interference.
2. This device must accept any interference received, including interference that may cause undesired operation.

**Note:** This equipment has been tested and found to comply with the limits for a Class A digital device, pursuant to Part 15 of the FCC Rules. These limits are designed to provide reasonable protection against harmful interference when the equipment is operated in a commercial environment. This equipment generates, uses and can radiate radio frequency energy and, if not installed and used in accordance with the instruction manual, may cause harmful interference to radio communications. Operation of this equipment in a residential area is likely to cause harmful interference in which case the user will be required to correct the interference at his own expense.

**Shielded Cables:** Connections between the workstation and peripherals must be made using shielded cables in order to maintain compliance with FCC radio frequency emission limits. Networking connections can be made using unshielded twisted-pair (UTP) cables.

**Modifications:** Any modifications made to this device that are not approved by Sun Microsystems, Inc. may void the authority granted to the user by the FCC to operate this equipment.

### FCC Class B Notice

This device complies with Part 15 of the FCC Rules. Operation is subject to the following two conditions:

1. This device may not cause harmful interference.
2. This device must accept any interference received, including interference that may cause undesired operation.

**Note:** This equipment has been tested and found to comply with the limits for a Class B digital device, pursuant to Part 15 of the FCC Rules. These limits are designed to provide reasonable protection against harmful interference in a residential installation. This equipment generates, uses and can radiate radio frequency energy and, if not installed and used in accordance with the instructions, may cause harmful interference to radio communications. However, there is no guarantee that interference will not occur in a particular installation. If this equipment does cause harmful interference to radio or television reception, which can be determined by turning the equipment off and on, the user is encouraged to try to correct the interference by one or more of the following measures:

- Reorient or relocate the receiving antenna.
- Increase the separation between the equipment and receiver.
- Connect the equipment into an outlet on a circuit different from that to which the receiver is connected.
- Consult the dealer or an experienced radio/television technician for help.

**Shielded Cables:** Connections between the workstation and peripherals must be made using shielded cables in order to maintain compliance with FCC radio frequency emission limits. Networking connections can be made using unshielded twisted pair (UTP) cables.

**Modifications:** Any modifications made to this device that are not approved by Sun Microsystems, Inc. may void the authority granted to the user by the FCC to operate this equipment.

## DOC Class A Notice - Avis DOC, Classe A

This Class A digital apparatus meets all requirements of the Canadian Interference-Causing Equipment Regulations.  
Cet appareil numérique de la classe A respecte toutes les exigences du Règlement sur le matériel brouilleur du Canada.

## DOC Class B Notice - Avis DOC, Classe B

This Class B digital apparatus meets all requirements of the Canadian Interference-Causing Equipment Regulations.  
Cet appareil numérique de la classe B respecte toutes les exigences du Règlement sur le matériel brouilleur du Canada.

## VCCI 基準について

### 第一種 VCCI 基準について

第一種VCCIの表示があるワークステーションおよびオプション製品は、第一種情報装置です。これらの製品には、下記の項目が該当します。

この装置は、第一種情報装置(商工業地域において使用されるべき情報装置)で商工業地域での電波障害防止を目的とした情報処理装置等電波障害自主規制協議会(VCCI)基準に適合しております。したがって、本製品を、住宅地域または住宅地域に隣接した地域でご使用になりますと、ラジオ、テレビジョン受信機等に受信障害を与えることがあります。

取り扱い説明書に従って正しくお取り扱いください。

### 第二種 VCCI 基準について

第二種VCCIの表示  があるワークステーションおよびオプション製品は、第二種情報装置です。これらの製品には、下記の項目が該当します。

この装置は、第二種情報装置(住宅地域または住宅地域に隣接した地域において使用されるべき情報装置)で住宅地域での電波障害防止を目的とした情報処理装置等電波障害自主規制協議会(VCCI)基準に適合しております。しかし、本製品を、ラジオ、テレビジョン受信機に近接してご使用になりますと、受信障害の原因となることがあります。

取り扱い説明書に従って正しくお取り扱いください。

# Contents

---

**Preface vii**

**1. Tools and Safety 1**

Tools Required 1

Upgrade Kit 1

Safety Requirements 2

    Symbols 3

    System Precautions 4

    Lithium Battery 4

**2. Performing the Upgrade 5**

Overview 5

Powering Off the System 6

Removing the Ultra 1 Series Cover 8

Attaching the Antistatic Wrist Strap 9

Removing DIMMs 10

Removing a CD-ROM Drive 13

    Removing the Bracket From the Chassis 13

    Removing the CD-ROM Drive From the Bracket 15

    Replacing the Bracket Into the Chassis 16

Replacing the Cover 18

Returning the Old System 18

# Preface

---

This document describes how to upgrade a Sun™ Ultra™ 1 or Ultra 1 Creator Series system to a Sun™ Ultra 60 system.

---

## Who Should Use This Book

You should read this book if you want to upgrade a Ultra 1 Series system to a Ultra 60 system.

---

## How This Book Is Organized

**Chapter 1 “Tools and Safety,”** outlines the process to be followed in upgrading a Sun Ultra 1 or Ultra 1 Creator Series system to a Sun Ultra 60 System.

**Chapter 2 “Performing the Upgrade,”** describes how to remove components from an Ultra 1 Series system to be transferred to an Ultra 60 System.

---

## Related Books

The following documents contain topics that relate to the information in *Sun Ultra 1 Series to Sun Ultra 60 System Upgrade Guide*.

- *Sun Ultra 60 Hardware Setup Instructions, 805-1705*
- *Sun Ultra 60 Installation Guide, 805-1706, 805-1707, 805-1708*

---

## Ordering Sun Documents

The SunDocs<sup>SM</sup> program provides more than 250 manuals from Sun Microsystems, Inc. If you live in the United States, Canada, Europe, or Japan, you can purchase documentation sets or individual manuals using this program.

For a list of documents and how to order them, see the catalog section of the SunExpress<sup>TM</sup> Internet site at <http://www.sun.com/sunexpress>.

---

## Accessing Sun Documentation Online

The [docs.sun.com](http://docs.sun.com) Web site enables you to access Sun technical documentation online. You can browse the [docs.sun.com](http://docs.sun.com) archive or search for a specific book title or subject. The URL is <http://docs.sun.com/>.



---

# What Typographic Changes Mean

The following table describes the typographic changes used in this book.

TABLE P-1 Typographic Conventions

Typeface or Symbol	Meaning	Example
AaBbCc123	The names of commands, files, and directories; on-screen computer output	Edit your <code>.login</code> file. Use <code>ls -a</code> to list all files. <code>machine_name%</code> You have mail.
AaBbCc123	What you type, contrasted with on-screen computer output	<code>machine_name% su</code> Password:
AaBbCc123	Command-line placeholder: replace with a real name or value	To delete a file, type <code>rm filename</code> .
AaBbCc123	Book titles, new words or terms, or words to be emphasized	Read Chapter 6 in <i>User's Guide</i> . These are called <i>class</i> options. You <i>must</i> be root to do this.

---

# Shell Prompts in Command Examples

The following table shows the default system prompt and superuser prompt for the C shell, Bourne shell, and Korn shell.

TABLE P-2 Shell Prompts

Shell	Prompt
C shell prompt	<code>machine_name%</code>
C shell superuser prompt	<code>machine_name#</code>
Bourne shell and Korn shell prompt	<code>\$</code>
Bourne shell and Korn shell superuser prompt	<code>#</code>



# Tools and Safety

---

---

## Tools Required

You will need the following tools and equipment:

- Antistatic mat (included in upgrade kit)
- Wrist strap (included in upgrade kit)
- Phillips screwdriver
- Container for screws

---

## Upgrade Kit

The upgrade kit contains hardware parts and instructions needed to complete the upgrade process.

- Electrostatic discharge kit, part number 560-1302, so you can safely handle parts that are sensitive to static discharge damage.
- *Sun Ultra 1 Series to Sun Ultra 60 System Upgrade Guide*, (part number 805-1766).

---

# Safety Requirements

For your protection, observe the following safety requirements:

- Follow all cautions and instructions marked on the equipment.
- Ensure that the voltage and frequency rating of the power outlet to be used matches the electrical rating labels on the system.
- Use properly grounded power outlets.

To protect both yourself and the equipment, observe the safety precautions listed in TABLE 1-1.

**TABLE 1-1** Safety Precautions

Item	Problem	Precaution
AC power cord	Electrical shock	Disconnect the AC cord from the AC wall socket before working on the power supply.
	Grounding	Leave the AC power cord plugged into the AC wall outlet when replacing drives, DIMMs, chips, or the system board. Leave the AC power cord plugged into the wall outlet to provide a grounding path for the antistatic wrist strap, which you must wear while servicing the system.
Power On/Standby switch	Electric shock	Remove the DC power from the system by disconnecting the AC power cord from the system <i>before</i> disconnecting a working unit or connecting a replacement unit.  Note: The power supply "remembers" the state it was in when power was interrupted. If it is not set to Standby before being disconnected, the power supply will turn on automatically when it is connected again. This occurs even if the Power On/Standby switch or keyboard power key is not pressed.
Antistatic wrist strap	Electrostatic Discharge (ESD)	Wear a grounded antistatic wrist strap when handling printed circuit boards, drives, or other components such as DIMMs.
ESD mat	ESD	An approved antistatic mat, when used with an antistatic wrist strap, provides protection from static damage and cushions and protects small parts that are attached to printed circuit boards.  Place all components removed from the system onto the ESD mat.
Printed circuit board	ESD	Handle a printed circuit board by the edges only. Store printed-circuit boards in antistatic bags.

TABLE 1-1 Safety Precautions (Continued)

Item	Problem	Precaution
Cover	System damage and overheating	Replace the cover after servicing the system.
SBus slot filler panels	System damage and overheating	Install filler panels in all unused SBus slots. Openings on the back panel reduce the cooling capability of the system and allow EMI emissions that exceed FCC compliance limits.
Heat sinks on processor modules and system boards	Heat, burns	Do not touch the metal heat sinks on processor modules or the system board. The heat sinks can be hot enough to cause injury.

## Symbols

The following symbols mean:



**Caution** – This equipment contains lethal voltages. Accidental contact can result in serious injury or death.



**Caution** – Physical danger due to a non-electrical hazard or danger of irreversible damage to data or to the operating system.



**Caution** – Improper handling by unqualified personnel can cause serious damage to this equipment. Unqualified personnel who tamper with this equipment may be held liable for any resulting damage to the equipment.



**Caution** – Hot surface. Avoid contact. Surfaces are hot and may cause injury if touched.

# System Precautions

Observe all safety precautions and ensure compliance with skill level requirements, certification, and all applicable local and national laws.



---

**Caution** – Before you begin, carefully read each of the procedures in this manual. If you have not performed similar operations on comparable equipment, *do not* attempt to perform these procedures.

---

## Lithium Battery



---

**Caution** – On Ultra 1 Series system boards, a lithium battery is molded into the real-time clock, SGS No. MK48T18, MK48T08x-xxx, MT48TxxB-xxx, or MK48T18-xxxPCZ. Batteries are not customer replaceable parts. They may explode if mistreated. Do not dispose of the battery in fire. Do not disassemble it or attempt to recharge it.

---

# Performing the Upgrade

---

---

## Overview

1. Read the documentation in the RMA (Return Material Authorization) information package provided with the upgrade.
2. Follow the procedures described in this chapter:
  - a. Power off the system and all attached peripheral devices.
  - b. Disconnect all devices attached to the Ultra 1 Series system, including monitor, keyboard, mouse, and associated cables.
  - c. Remove all DIMMs (memory modules) and any CD-ROM drive installed in the Ultra 1 Series system, and install them in the Ultra 60 system.

For information about installing components into a Ultra 60 workstation, refer to the *Ultra 60 Installation Guide*.

---

**Note** – SBus cards are not supported by the Ultra 60 system.

---

- d. Connect the monitor, keyboard, and mouse to the Ultra 60 system as shown in the *Ultra 60 Installation Guide*.
3. Follow the instructions in the RMA information package about packing and returning the SPARCstation 20 enclosure and those components not moved to the Ultra 60.

If you have any additional questions, contact your Sun sales representative.

---

# Powering Off the System



---

**Caution** – When the Power switch is set to standby and the AC power cord remains connected to a power outlet, hazardous AC voltage is still present in the power supply primary.

The power supply ‘remembers’ the state it was in when power was interrupted. Press the Power switch to Standby before you disconnect a working unit or connect a replacement unit. If the power supply is not placed in standby *before* it is disconnected, it turns on automatically when it is connected again, even if you do not touch the system power switch or keyboard buttons.

---

1. **If the Ultra 1 Series system that you are upgrading is being used as a server, notify users that the system is going down.**
2. **Back up system files and data.**
3. **If the system that you are upgrading is being used as a server, shutdown the operating system by becoming superuser and issuing the shutdown command.**

```
kiwi% su
Password:
# shutdown -gl -y
```



---

**Caution** – Failure to shut down the operating system can result in loss of data.

---

4. **Turn off the power to the monitor.**
5. **Turn off all attached external devices.**



6. Press the power on/standby switch to standby (⏻) (FIGURE 2-1).
7. Verify the following:
  - a. Front panel LED is off.
  - b. System fans are off.

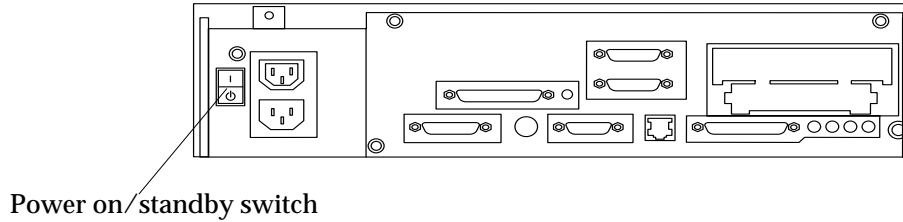

FIGURE 2-1 Rear View of an Ultra 1 System

8. Detach all cords and cables connected to the system unit *except* for the AC power cord.

The AC power cord provides the grounding path for safely discharging static electricity.

---

# Removing the Ultra 1 Series Cover

1. Use a Phillips screwdriver to remove the lock block (if installed) on the cover (FIGURE 2-2).

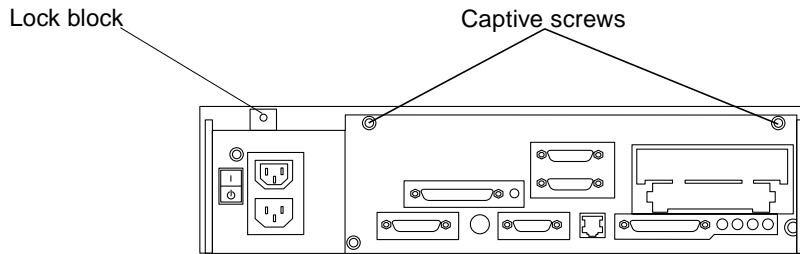

FIGURE 2-2 Location of Lock Block

2. Use a Phillips screwdriver to loosen the captive screws securing the cover with a Phillips screwdriver. (FIGURE 2-2).
3. Grasp the sides of the cover and lift up the back of the cover (FIGURE 2-3). After the cover clears the back panel, push the cover away from the front panel.

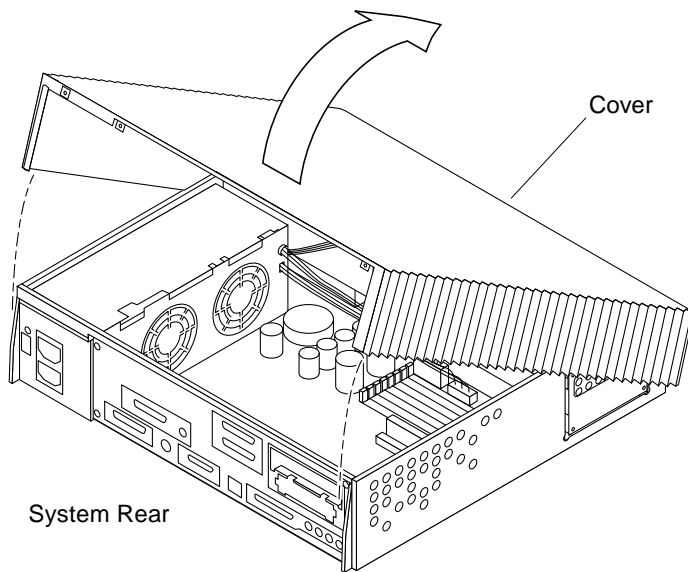
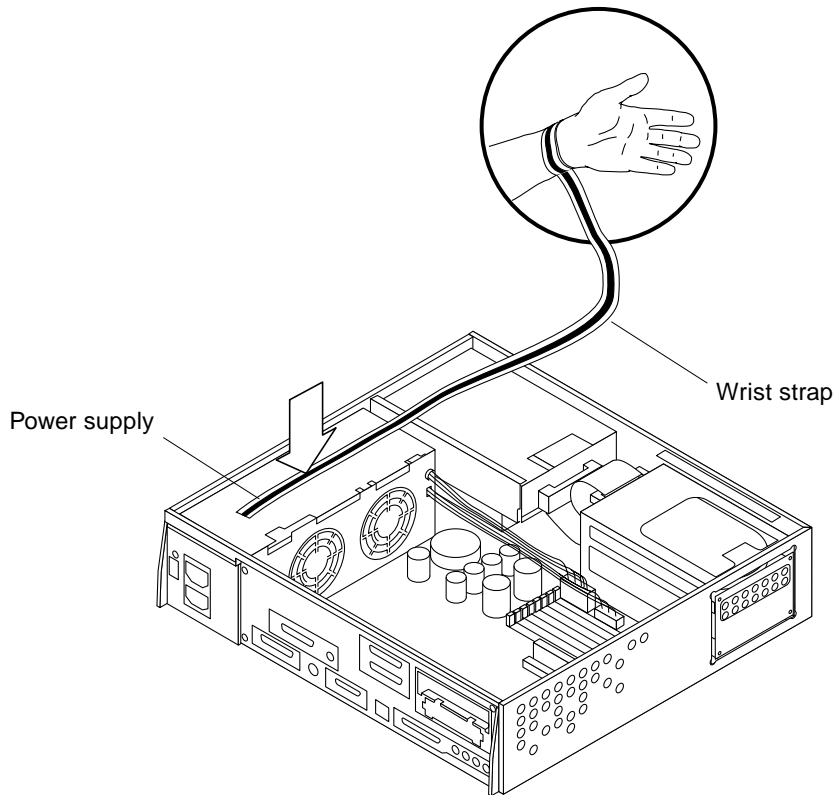

FIGURE 2-3 Removing the Cover

---

# Attaching the Antistatic Wrist Strap

1. Locate the antistatic wrist strap and attach its adhesive copper strip to the metal casing of the power supply. Wrap the other end twice around your wrist, with the sticky side against your skin (FIGURE 2-4).



**FIGURE 2-4** Attaching the Antistatic Wrist Strap

When used properly, a wrist strap keeps static electricity from building up on your hands.

---

# Removing DIMMs

---



**Caution** – A DIMM is made of delicate electronic components that are extremely sensitive to static electricity. Handle a DIMM only by the edges. Do not touch the components on the DIMM or any metal parts. Wear an antistatic wrist strap before unpacking and while handling a DIMM. Ordinary amounts of static from your clothes or work environment can damage a DIMM.

**Do not disconnect the power cord from the system unit back panel. The power cord should also be connected to a grounded power outlet.** This connection provides the necessary ground path to safely remove and install DIMMs and other components.

Be sure that the system unit power switch is set to Standby. Check the green light at the front of the chassis to be sure it is off.

---

All Ultra 1 Series systems have at least two identical DIMMs, each pair having the same speed and capacity, installed in paired sockets of any DIMM bank.

Each DIMM has chips mounted on both sides. The part of the DIMM that connects in the memory slot has gold “fingers,” a scalloped edge with a conductive surface.

FIGURE 2-5 and FIGURE 2-6 show front and back views of a DIMM. When installed, the key notch should be near the DIMM ejector levers.

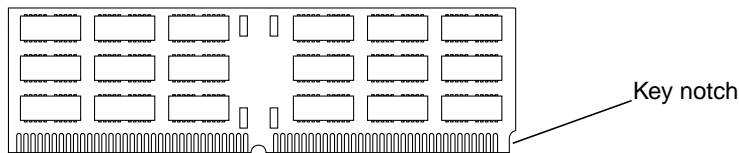

**FIGURE 2-5** DIMM—Front View

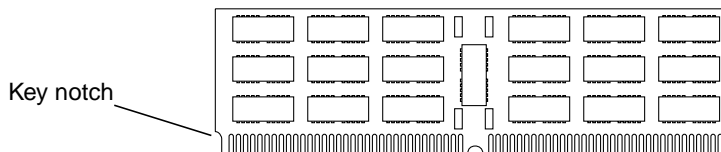

**FIGURE 2-6** DIMM—Back View

1. Place the antistatic mat next to the system.
2. Locate the DIMM to be removed (FIGURE 2-8).
3. Use your fingers or the eraser end of a pencil to move the ejection lever away from the DIMM that you want to remove.

Ejection levers are greatly enlarged to show detail in FIGURE 2-7.

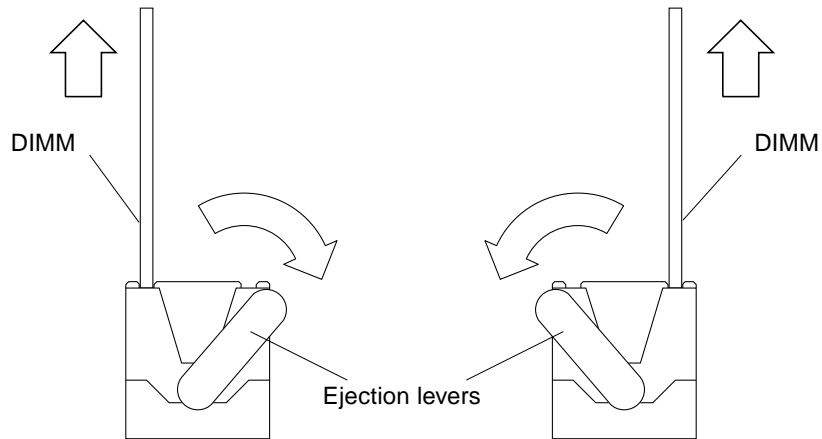

**FIGURE 2-7** DIMM Ejection Levers

4. Grasp the upper corners of the DIMM and lift to remove it from the slot.

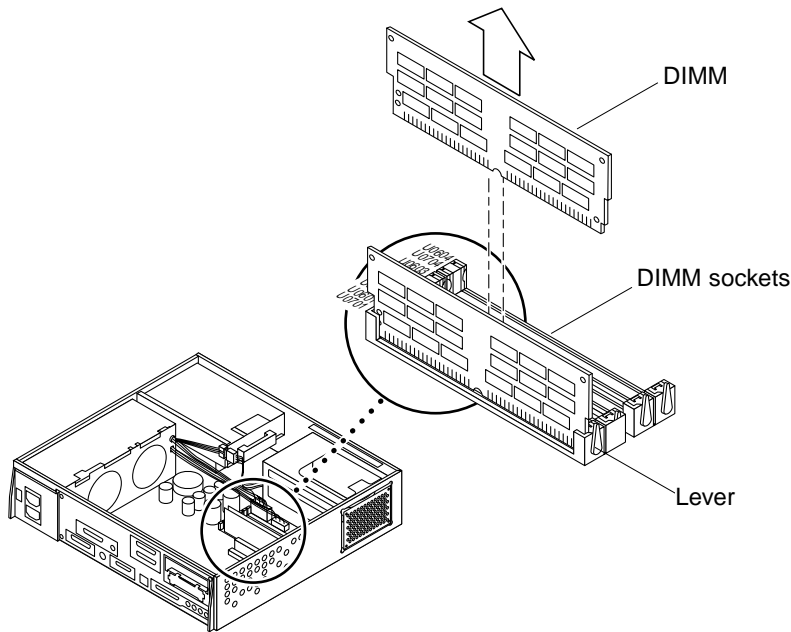

FIGURE 2-8 Removing a DIMM

5. Set the DIMM aside on the antistatic mat.

6. Install the DIMM into the Ultra 60.

See the *Sun Ultra 60 Installation Guide* for instructions.

---

**Note** – DIMMs in a Ultra 60 must be installed in groups of four. Each pair of DIMMs installed in a given bank of four must be of the same speed and capacity.

If the Ultra 1 Series system has only one pair of DIMMs of a given speed and capacity, you must obtain additional DIMMs of the same speed and capacity to the Ultra 60 to fill the memory bank.

---

---

# Removing a CD-ROM Drive

## Removing the Bracket From the Chassis

1. Remove the two screws from the chassis that secure the drive bracket (FIGURE 2-9).
2. Remove the DC harness from the clip located on the drive bracket (FIGURE 2-9).
3. Disconnect the DC harness from the peripheral power cable at P1.
4. Push the drive bracket toward the disk drive bay and gently flip it over. Place the drive bracket on top of the disk drive bay (FIGURE 2-10).
5. Place the bracket on the antistatic mat.

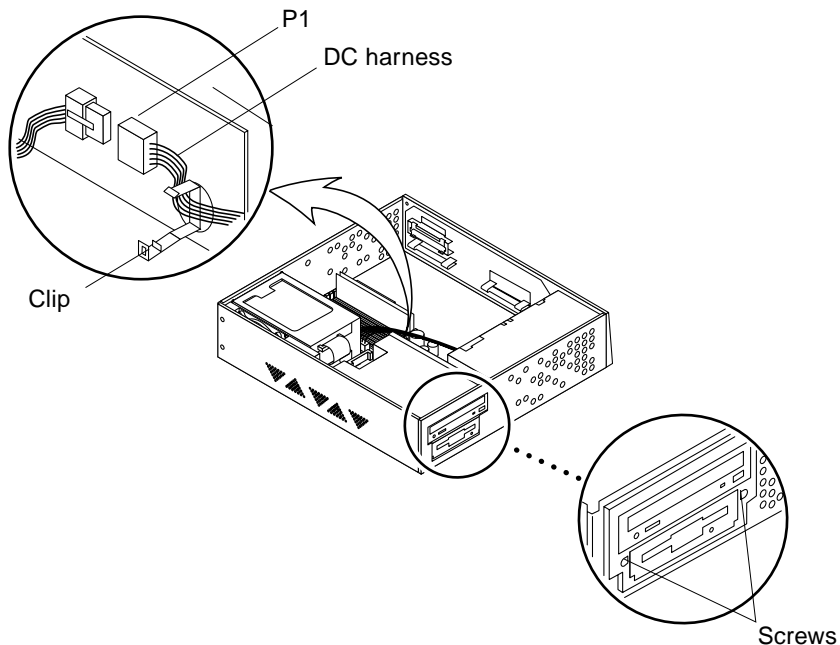
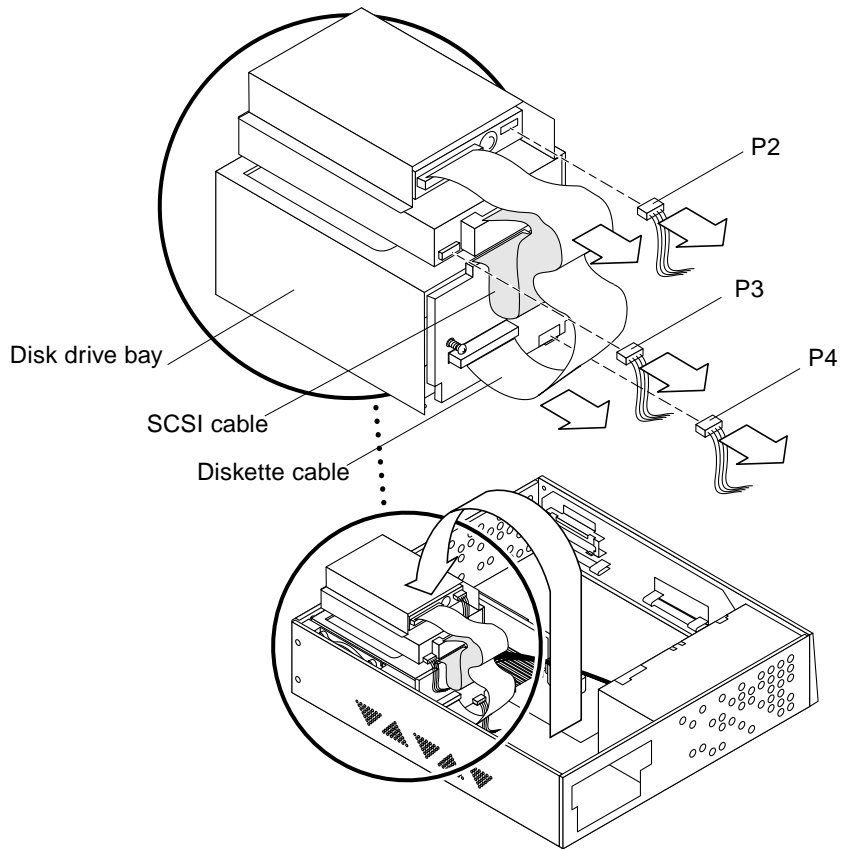

FIGURE 2-9 Drive Bracket

6. Disconnect the SCSI cable from the CD-ROM drive (FIGURE 2-10).



**FIGURE 2-10** Placing the Drive Bracket on Top of the Disk Drive

- 7. Disconnect the peripheral power cable from the CD-ROM drive (P3), and from the diskette drive (P2).**
- 8. If present, disconnect the diskette cable from the diskette drive.**



# Removing the CD-ROM Drive From the Bracket

1. **Position the bracket on top of a flat surface, so that the CD-ROM drive is flat** (FIGURE 2-11).
2. **Use a Phillips screwdriver to remove the four screws securing the CD-ROM drive to the drive bracket** (FIGURE 2-11).

---

**Note** – Save the four screws that you just removed. You will need them to install the drive in the Ultra 60 system.

---

3. **Remove the CD-ROM drive, and place it aside on an antistatic surface.**

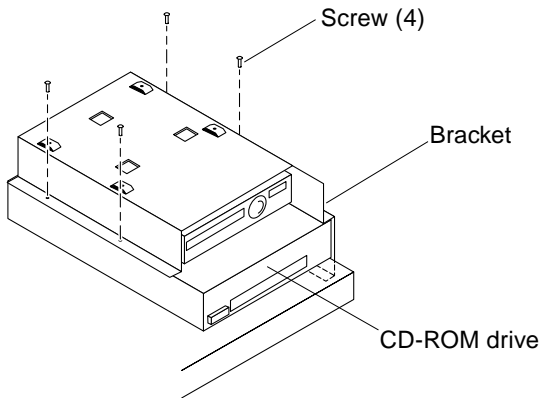

FIGURE 2-11 Positioning the CD-ROM Drive

4. **Install the CD-ROM drive in the Ultra 60 system.**  
Refer to the *Ultra 60 Installation Guide* for installation instructions.

# Replacing the Bracket Into the Chassis

1. **Place the drive bracket on top of the disk drive bay (FIGURE 2-12).**

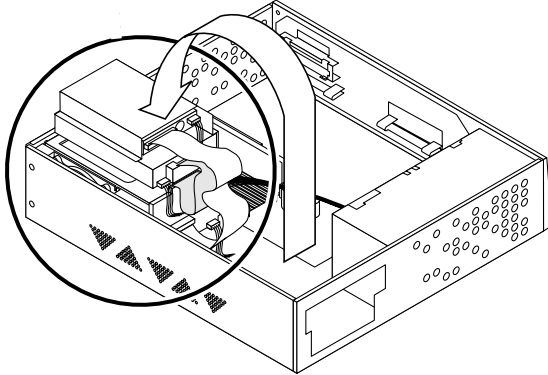

FIGURE 2-12 Replacing the Drive Bracket in the Disk Drive Bay

2. **Position the bracket in the chassis.**
3. **Slide the bracket toward the opening in the side of the chassis (FIGURE 2-13).**

---

**Note** – Hooks at the chassis base must lock into the bottom holes of the drive bracket.

---

4. **Replace the two screws securing the drive bracket to the chassis.**

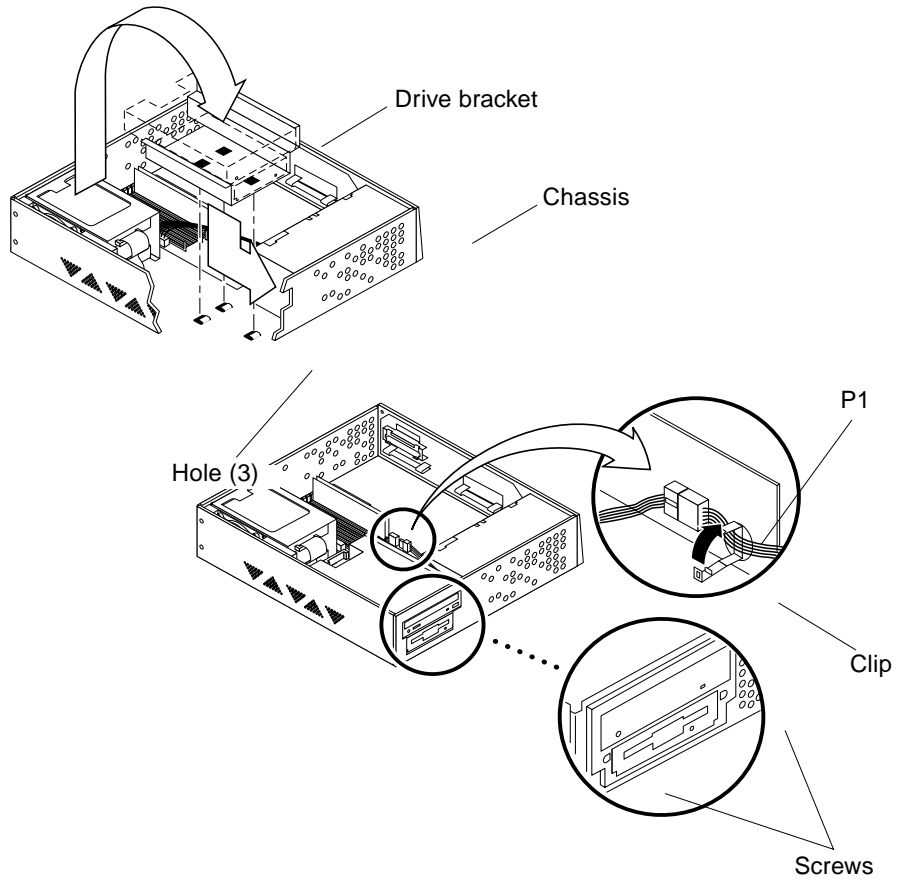

**FIGURE 2-13** Positioning the Drive Bracket in the Chassis

---

## Replacing the Cover

1. Remove the antistatic wrist strap from your wrist and from the power supply.
2. Position the cover on the system chassis as shown (FIGURE 2-14).
3. Lower the back side of the cover until the channels on each side of the cover align with the two flanges at the rear of the system. Press down on both sides of the cover until it is firmly seated (FIGURE 2-14).
4. Tighten the captive screws on the back panel with a Phillips screwdriver.
5. Replace the lock block with a Phillips screwdriver (FIGURE 2-2).

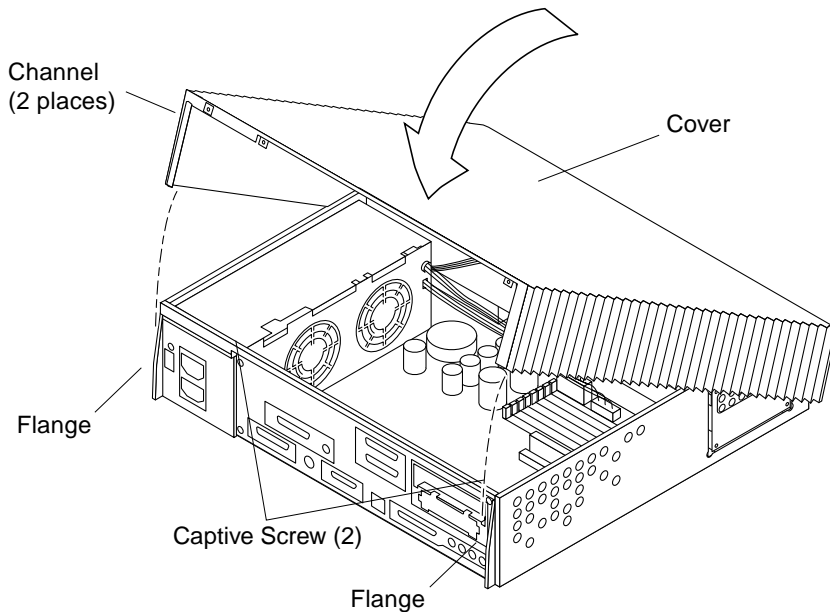

FIGURE 2-14 Replacing the Cover

---

## Returning the Old System

Follow the instructions in the RMA documentation to repackage and return the Ultra 1 Series system to Sun.