



# Sun Fire™ V440 Server Parts Installation and Removal Guide

---

Sun Microsystems, Inc.  
4150 Network Circle  
Santa Clara, CA 95054 U.S.A.  
650-960-1300

Part No. 816-7729-10  
July 2003, Revision A

Send comments about this document to: <http://www.sun.com/hwdocs/feedback>

Copyright 2003 Sun Microsystems, Inc., 4150 Network Circle, Santa Clara, California 95054, U.S.A. All rights reserved.

Sun Microsystems, Inc. has intellectual property rights relating to technology that is described in this document. In particular, and without limitation, these intellectual property rights may include one or more of the U.S. patents listed at <http://www.sun.com/patents> and one or more additional patents or pending patent applications in the U.S. and in other countries.

This document and the product to which it pertains are distributed under licenses restricting their use, copying, distribution, and decompilation. No part of the product or of this document may be reproduced in any form by any means without prior written authorization of Sun and its licensors, if any.

Third-party software, including font technology, is copyrighted and licensed from Sun suppliers.

Parts of the product may be derived from Berkeley BSD systems, licensed from the University of California. UNIX is a registered trademark in the U.S. and in other countries, exclusively licensed through X/Open Company, Ltd.

Sun, Sun Microsystems, the Sun logo, AnswerBook2, docs.sun.com, Sun Fire, Solaris, VIS, Sun StorEdge, Solstice DiskSuite, Java, Sun VTS and the Solaris logo are trademarks or registered trademarks of Sun Microsystems, Inc. in the U.S. and in other countries.

All SPARC trademarks are used under license and are trademarks or registered trademarks of SPARC International, Inc. in the U.S. and in other countries. Products bearing SPARC trademarks are based upon an architecture developed by Sun Microsystems, Inc.

The OPEN LOOK and Sun™ Graphical User Interface was developed by Sun Microsystems, Inc. for its users and licensees. Sun acknowledges the pioneering efforts of Xerox in researching and developing the concept of visual or graphical user interfaces for the computer industry. Sun holds a non-exclusive license from Xerox to the Xerox Graphical User Interface, which license also covers Sun's licensees who implement OPEN LOOK GUIs and otherwise comply with Sun's written license agreements.

U.S. Government Rights—Commercial use. Government users are subject to the Sun Microsystems, Inc. standard license agreement and applicable provisions of the FAR and its supplements.

DOCUMENTATION IS PROVIDED "AS IS" AND ALL EXPRESS OR IMPLIED CONDITIONS, REPRESENTATIONS AND WARRANTIES, INCLUDING ANY IMPLIED WARRANTY OF MERCHANTABILITY, FITNESS FOR A PARTICULAR PURPOSE OR NON-INFRINGEMENT, ARE DISCLAIMED, EXCEPT TO THE EXTENT THAT SUCH DISCLAIMERS ARE HELD TO BE LEGALLY INVALID.

---

Copyright 2003 Sun Microsystems, Inc., 4150 Network Circle, Santa Clara, California 95054, Etats-Unis. Tous droits réservés.

Sun Microsystems, Inc. a les droits de propriété intellectuelle relatants à la technologie qui est décrit dans ce document. En particulier, et sans la limitation, ces droits de propriété intellectuelle peuvent inclure un ou plus des brevets américains énumérés à <http://www.sun.com/patents> et un ou les brevets plus supplémentaires ou les applications de brevet en attente dans les Etats-Unis et dans les autres pays.

Ce produit ou document est protégé par un copyright et distribué avec des licences qui en restreignent l'utilisation, la copie, la distribution, et la décompilation. Aucune partie de ce produit ou document ne peut être reproduite sous aucune forme, par quelque moyen que ce soit, sans l'autorisation préalable et écrite de Sun et de ses bailleurs de licence, s'il y ena.

Le logiciel détenu par des tiers, et qui comprend la technologie relative aux polices de caractères, est protégé par un copyright et licencié par des fournisseurs de Sun.

Des parties de ce produit pourront être dérivées des systèmes Berkeley BSD licenciés par l'Université de Californie. UNIX est une marque déposée aux Etats-Unis et dans d'autres pays et licenciée exclusivement par X/Open Company, Ltd.

Sun, Sun Microsystems, le logo Sun, AnswerBook2, docs.sun.com, Sun Fire, Solaris, VIS, Sun StorEdge, Solstice DiskSuite, Java, Sun VTS, et le logo de Solaris sont des marques de fabrique ou des marques déposées de Sun Microsystems, Inc. aux Etats-Unis et dans d'autres pays.

Toutes les marques SPARC sont utilisées sous licence et sont des marques de fabrique ou des marques déposées de SPARC International, Inc. aux Etats-Unis et dans d'autres pays. Les produits protant les marques SPARC sont basés sur une architecture développée par Sun Microsystems, Inc.

L'interface d'utilisation graphique OPEN LOOK et Sun™ a été développée par Sun Microsystems, Inc. pour ses utilisateurs et licenciés. Sun reconnaît les efforts de pionniers de Xerox pour la recherche et le développement du concept des interfaces d'utilisation visuelle ou graphique pour l'industrie de l'informatique. Sun détient une licence non exclusive de Xerox sur l'interface d'utilisation graphique Xerox, cette licence couvrant également les licenciées de Sun qui mettent en place l'interface d'utilisation graphique OPEN LOOK et qui en outre se conforment aux licences écrites de Sun.

LA DOCUMENTATION EST FOURNIE "EN L'ÉTAT" ET TOUTES AUTRES CONDITIONS, DECLARATIONS ET GARANTIES EXPRESSES OU TACITES SONT FORMELLEMENT EXCLUES, DANS LA MESURE AUTORISEE PAR LA LOI APPLICABLE, Y COMPRIS NOTAMMENT TOUTE GARANTIE IMPLICITE RELATIVE A LA QUALITE MARCHANDE, A L'APTITUDE A UNE UTILISATION PARTICULIERE OU A L'ABSENCE DE CONTREFAÇON.



Adobe PostScript

# Contents

---

**Preface** vii

- 1. Identifying Front Panel and Back Panel Features** 1
  - Locating Front Panel Features 2
  - Locating Back Panel Features 9
  - Locating Internal Components 15
  
- 2. Preparing to Service the System** 17
  - Service Guidelines 18
  - Tools Required for Installation and Service 18
  - How to Power On the System 19
  - How to Power Off the System 23
  - How to Initiate a Reconfiguration Boot 26
  - How to Slide the System Out of the Cabinet 29
  - How to Slide the System Into the Cabinet 32
  - How to Remove the Top Cover 34
  - How to Install the Top Cover 35
  - How to Remove the System From the Cabinet 36
  - How to Install the System Into the Cabinet 39
  - How to Avoid Electrostatic Discharge 44

- 3. Servicing the Front Panel Removable Devices 47**
  - About Hot-Pluggable Components 48
  - How to Remove a Power Supply 48
  - How to Install a Power Supply 51
  - How to Remove a Power Supply Using the Hot-Plug Operation 52
  - How to Install a Power Supply Using the Hot-Plug Operation 55
  - How to Remove a Disk Drive 57
  - How to Install a Disk Drive 60
  - How to Remove a Disk Drive Using the Hot-Plug Operation 62
  - How to Install a Disk Drive Using the Hot-Plug Operation 64
  
- 4. Servicing the Fans 67**
  - How to Remove the PCI Fan Tray 67
  - How to Install the PCI Fan Tray 70
  - How to Remove the CPU Fan Tray 73
  - How to Install the CPU Fan Tray 75
  
- 5. Servicing the Motherboard Components 79**
  - How to Remove a CPU/Memory Module 80
  - How to Install a CPU/Memory Module 83
  - About the Memory Modules 86
  - How to Remove a Memory Module 88
  - How to Install a Memory Module 90
  - How to Remove a PCI Card 93
  - How to Install a PCI Card 95
  - How to Remove the ALOM Card 97
  - How to Install the ALOM Card 99
  - How to Remove the Motherboard 101
  - How to Install the Motherboard 107

<b>6. Servicing Miscellaneous Components</b>	<b>115</b>
How to Remove the DVD-ROM Drive	116
How to Install the DVD-ROM Drive	117
How to Remove the System Configuration Card	119
How to Install the System Configuration Card	120
How to Remove the System Configuration Card Reader	122
How to Install the System Configuration Card Reader	124
How to Remove the Connector Board	126
How to Install the Connector Board	128
How to Remove the SCSI Backplane	130
How to Install the SCSI Backplane	133
<b>7. Servicing Cables</b>	<b>137</b>
Cable Connections and Routing	138
How to Remove the SCC Reader Cable	139
How to Install the SCC Reader Cable	141
How to Remove the System Control Keypress Cable	142
How to Install the System Control Keypress Cable	144
How to Remove the Connector Board Power Cable	146
How to Install the Connector Board Power Cable	148
How to Remove the SCSI Data Cable	150
How to Install the SCSI Data Cable	151
How to Remove the DVD-ROM Cable	152
How to Install the DVD-ROM Cable	154
<b>A. Connector Pinouts</b>	<b>157</b>
Reference for the Serial Port Connector	158
Reference for the USB Connectors	159
Reference for the Gigabit Ethernet Connectors	160

Reference for the Network Management Connector 161

Reference for the Serial Management Connector 162

Reference for the SCSI Connector 163

**B. System Specifications 165**

Reference for Physical Specifications 166

Reference for Electrical Specifications 166

Reference for Environmental Specifications 167

Reference for Agency Compliance Specifications 168

Reference for Clearance and Service Access Specifications 168

**C. Board Connector Locations 169**

Motherboard Connectors 170

SCSI Backplane Connectors 171

Connector Board Connectors 171

ALOM Card Connectors 172

SCC Reader Connectors 172

**D. Illustrated Parts Breakdown 173**

Front Panel Components 174

Fan Components 175

Motherboard Components 176

Miscellaneous Components 177

System Cables 178

**Index 179**

# Preface

---

The *Sun Fire V440 Server Parts Installation and Removal Guide* includes detailed service procedures for the Sun Fire™ V440 server. This book is intended for technicians, system administrators, qualified Sun service providers, and advanced computer system end users who have experience removing and installing server hardware.

For information about the Sun Fire V440 server and detailed instructions for configuring and administering the server, see the *Sun Fire V440 Server Administration Guide*.

For information about diagnosing problems with the server, see the *Sun Fire V440 Server Diagnostics and Troubleshooting Guide*.

This book does not cover the initial installation of the server. For those instructions, see the *Sun Fire V440 Server Installation Guide*.

---

## Before You Read This Book

Follow the instructions for mounting the server in a cabinet before continuing with the removal and installation instructions in this book.

You can find rackmounting instructions on the system top cover label and in the *Sun Fire V440 Server Installation Guide*.

---

# How This Book Is Organized

The procedures in this book are organized as follows:

- *Before You Begin* – This section lists the procedures that you must complete before proceeding to the next section. Complete these prerequisite procedures in the sequence in which they are printed.
- *What to Do* – This section explains the procedure. Complete the steps in the sequence in which they are printed, paying special attention to notes and cautions.
- *What Next* – This section lists the procedures that you must complete to finish the current procedure or to return the system to operation. Complete these procedures in the sequence in which they are printed.

This book contains the following chapters:

- Chapter 1 illustrates the front panel and back panel features and LED indicators.
- Chapter 2 offers procedures for powering on and powering off the system. In addition, it describes how to prepare the system for service, including the tools required, and how to avoid electrostatic discharge.
- Chapter 3 provides procedures for servicing components on the front panel, including disk drives and power supplies.
- Chapter 4 provides procedures for servicing the system fans.
- Chapter 5 contains procedures for servicing the motherboard components, including installing memory.
- Chapter 6 includes procedures for servicing the system configuration card, the DVD-ROM drive, the SCSI backplane, and the connector board.
- Chapter 7 presents procedures for servicing cables, including how to route cables in the system.

This book also includes the following reference appendices:

- Appendix A is a reference for connector pinouts.
- Appendix B lists physical and environmental specifications.
- Appendix C is a reference for board connectors.
- Appendix D contains an illustrated parts breakdown, as well as a reference for field-replaceable unit (FRU) numbers.



---

# Using UNIX Commands

This document might not contain information on basic UNIX<sup>®</sup> commands and procedures such as shutting down the system, booting the system, and configuring devices.

See one or more of the following for this information:

- *Solaris Handbook for Sun Peripherals*
- AnswerBook2<sup>™</sup> online documentation for the Solaris<sup>™</sup> operating environment
- Other software documentation that you received with your system

---

# Typographic Conventions

Typeface <sup>1</sup>	Meaning	Examples
AaBbCc123	The names of commands, files, and directories; on-screen computer output	Edit your <code>.login</code> file. Use <code>ls -a</code> to list all files. % You have mail.
<b>AaBbCc123</b>	What you type, when contrasted with on-screen computer output	% <b>su</b> Password:
<i>AaBbCc123</i>	Book titles, new words or terms, words to be emphasized	Read Chapter 6 in the <i>User's Guide</i> . These are called <i>class</i> options. You <i>must</i> be superuser to do this.
<code>AaBbCc123</code>	Command-line variable; replace with a real name or value	To delete a file, type <code>rm filename</code> .

---

1. The settings on your browser might differ from these settings.

---

# System Prompts

Type of Prompt	Prompt
Bourne shell and Korn shell	\$
Bourne shell and Korn shell superuser	#
C shell	<i>machine-name%</i>
C shell superuser	<i>machine-name#</i>
OpenBoot firmware	ok
OpenBoot Diagnostics	obdiag>
ALOM system controller	sc>

---

# Related Documentation

Application	Title	Part Number
Late-breaking product information	<i>Sun Fire V440 Server Product Notes</i>	816-7733
Cabling and power-on overview	<i>Sun Fire V440 Server Setup: Cabling and Power On</i>	816-7734
System installation, including rack installation and cabling	<i>Sun Fire V440 Server Installation Guide</i>	816-7727
Administration	<i>Sun Fire V440 Server Administration Guide</i>	816-7728
Diagnostics and troubleshooting	<i>Sun Fire V440 Server Diagnostics and Troubleshooting Guide</i>	816-7730
Sun Advanced Lights Out Manager (ALOM) system controller	<i>Sun Advanced Lights Out Manager (ALOM) Online Help</i>	817-1960

---

## Accessing Sun Documentation Online

You can view, print, or purchase a broad selection of Sun documentation, including localized versions, at:

<http://www.sun.com/documentation>

---

**Note** – For important safety, compliance, and conformity information regarding the Sun Fire V440 server, see the *Sun Fire V440 Server Safety and Compliance Guide*, part number 816-7731, on the Documentation CD or online at the above location.

---

---

## Contacting Sun Technical Support

If you have technical questions about this product that are not answered in this document, go to:

<http://www.sun.com/service/contacting>

---

## Sun Welcomes Your Comments

Sun is interested in improving its documentation and welcomes your comments and suggestions. You can submit your comments by going to:

<http://www.sun.com/hwdocs/feedback>

Please include the title and part number of your document with your feedback:

*Sun Fire V440 Server Parts Installation and Removal Guide*, part number 816-7729



# Identifying Front Panel and Back Panel Features

---

This chapter contains the following sections:

- “Locating Front Panel Features” on page 2
- “Locating Back Panel Features” on page 9
- “Locating Internal Components” on page 15

For background information about the Sun Fire V440 server and detailed instructions for installing, configuring, and administering the server, see:

- *Sun Fire V440 Server Installation Guide*
- *Sun Fire V440 Server Administration Guide*

---

# Locating Front Panel Features

The illustration below shows the system features that you can access from the front panel. In the illustration, the system doors are removed.

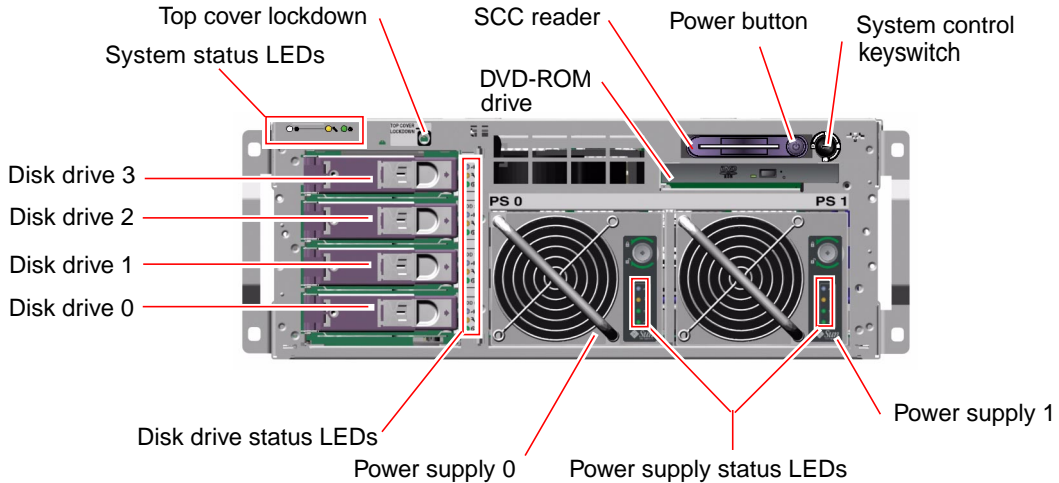

For information about front panel LEDs, see “Front Panel LEDs” on page 3.

The front door security lock controls access to all front panel components, including the system control keyswitch, Power button, disk drives, power supplies, and access to the top cover. The top cover controls access to all internal components.

---

**Note** – The same key operates the security lock and the system control keyswitch. Each system comes with a mini-key, which you can leave in the system control keyswitch when you close the system doors.

---

The system is configured with two power supplies and up to four disk drives, which are accessible from the front of the system.

# Front Panel LEDs

Several front panel LEDs provide general system status, alert you to system problems, and help you to determine the location of system faults.

During system startup, the LEDs are toggled on and off to verify that each one is working correctly. LEDs located on the front panel work in conjunction with specific fault LEDs. For example, a fault in the power supply subsystem illuminates the power supply Service Required LED on the affected power supply, as well as the system Service Required LED. Since all front panel status LEDs are powered by the system's standby power source, fault LEDs remain lit for any fault condition that results in a system shutdown.

## System Status LEDs

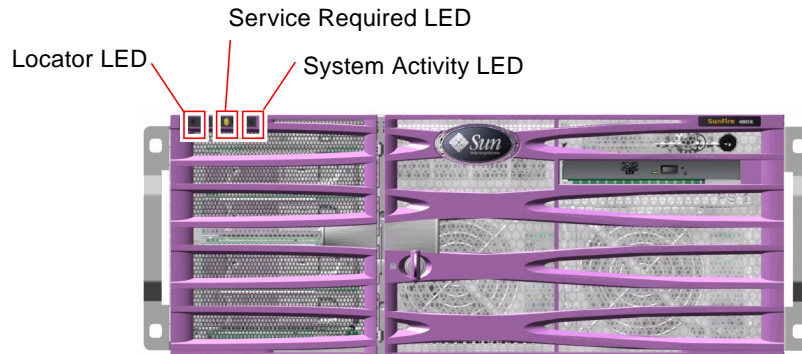

At the top left of the system as you look at its front are three system status LEDs. The System Activity LED and the system Service Required LED provide a snapshot of the overall system status. The Locator LED helps you to quickly locate a specific system even though it may be one of numerous systems in a room. The Locator LED is at the far left in the cluster, and is lit by command from the administrator.



Each system status LED has a corresponding LED on the back panel.

Listed from left to right, the system status LEDs operate as described in the following table.

**TABLE 1-1** System Status LEDs

Icon	Name	Description
	Locator	This white LED is lit by Solaris command, Sun Management Center command, or Advanced Lights Out Manager (ALOM) commands to help you locate the system. See the <i>Sun Fire V440 Server Administration Guide</i> for information about turning on the Locator LED.
	Service Required	<p>This amber LED lights steadily when a system fault is detected. For example, the system Service Required LED lights when a fault occurs in a power supply or disk drive.</p> <p>In addition to the system Service Required LED, other fault LEDs might also be lit, depending on the nature of the fault. If the system Service Required LED is lit, check the status of other fault LEDs on the front panel to determine the nature of the fault. See the <i>Sun Fire V440 Server Diagnostics and Troubleshooting Guide</i> for more information.</p>
	System Activity	This green LED lights continuously when the system power is on.



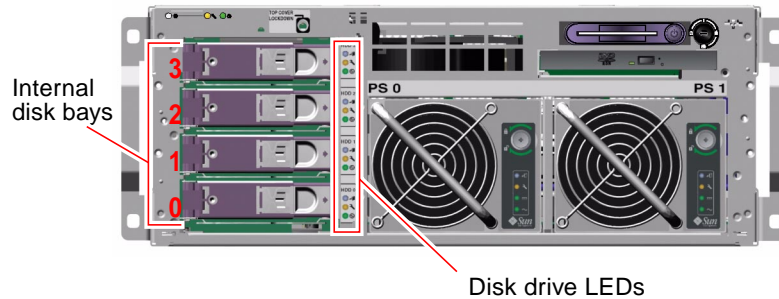

## Disk Drive Status LEDs

Each disk drive has its own status LEDs.



Listed from top to bottom, the disk drive LEDs operate as described in the following table.

**TABLE 1-2** Disk Drive LEDs

Icon	Name	Description
	OK-to-Remove	This blue LED lights when the disk drive has been taken offline and is ready to remove.
	Service Required	Reserved for future use.
	Activity	This green LED is lit when the disk drive is operating normally. It flashes slowly during the disk drive hot-plug procedure. It flashes rapidly when the disk is spinning up or down, or during read/write activity.

## Power Supply Status LEDs

Each power supply has its own status LEDs.

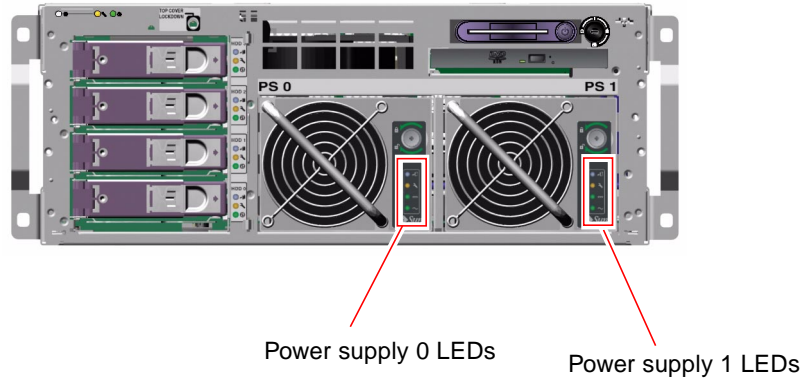

Each power supply LED has a corresponding LED on the back panel.

Listed from top to bottom, the power supply LEDs operate as described in the following table.

**TABLE 1-3** Power Supply LEDs

Icon	Name	Description
	OK-to-Remove	This blue LED lights when it is safe to remove and replace the power supply. This LED is lit by ALOM command and only lights when the other power supply is functioning correctly.
	Service Required	This amber LED lights to indicate a power supply fault. If a power supply Service Required LED is lit, the system Service Required LED is also lit.
	Power OK	This green LED is lit when the power supply is on and outputting regulated DC power within specified limits.
	Standby Available	This green LED is lit when AC input power is present. This LED is lit when the corresponding AC cable is plugged into a power source and the power supply is functioning correctly, regardless of system power status.

# Power Button

The system Power button is recessed to prevent accidentally turning the system on or off. The ability of the Power button to turn the system on or off is controlled by the system control keyswitch.

If the operating system is running, pressing and releasing the Power button initiates a graceful software system shutdown. Pressing and holding in the Power button for four seconds causes an immediate hardware shutdown.



---

**Caution** – Whenever possible, use the graceful shutdown method. Forcing an immediate hardware shutdown can cause disk drive corruption and loss of data.

---



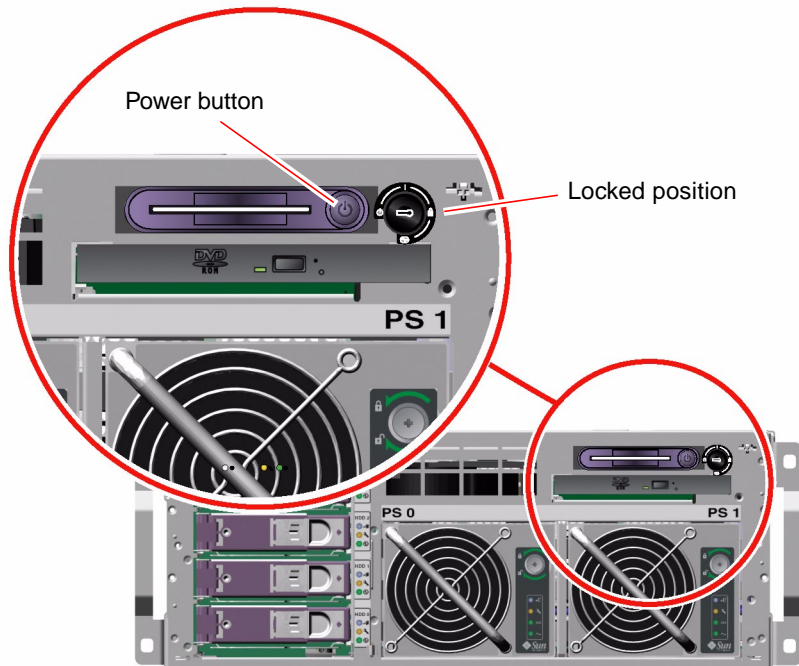

# System Control Keyswitch

The four-position system control keyswitch on the front panel controls the power-on modes of the system and prevents unauthorized users from powering off the system or reprogramming system firmware. In the following illustration, the system control keyswitch is in the Locked position.



The following table describes the function of each system control keyswitch setting.

**TABLE 1-4** System Control Keyswitch Settings

Icon	Name	Description
	Normal	This setting enables the system Power button to power the system on or off.
	Locked	<p>This setting disables the system Power button to prevent unauthorized users from powering the system on or off. It also disables the keyboard L1-A (Stop-A) command, terminal Break key command, and ~# tip window command, preventing users from suspending system operation to access the system ok prompt.</p> <p>The Locked setting, used for normal day-to-day operations, also prevents unauthorized programming of the system boot PROM firmware.</p>
	Diagnostics	This setting forces the power-on self-test (POST) and OpenBoot Diagnostics tests to run during system startup and system resets. The Power button functions the same as when the system control keyswitch is in the Normal position.
	Standby	<p>This setting forces the system to power off immediately and to enter standby mode. It also disables the Power button. You might want to use this setting when AC power is interrupted and you do not want the system to restart automatically when power is restored. With the system control keyswitch in any other position, if the system were running prior to losing power, it restarts automatically once power is restored.</p> <p>The Standby setting also prevents an ALOM console from restarting the system. However, the ALOM card continues to operate using the system's standby power.</p>

---

# Locating Back Panel Features

The illustration below shows the system features that are accessible from the back panel.

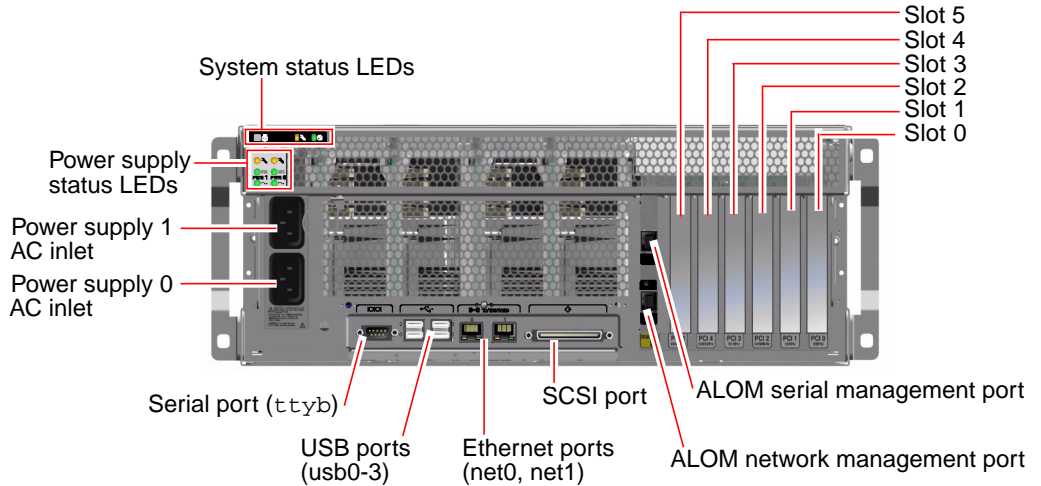

## Back Panel LEDs

The back panel LEDs include the system status LEDs, the Ethernet port LEDs, the power supply LEDs, and the ALOM card LED. The system status LEDs and the power supply LEDs are replicated from the front panel.

## System Status LEDs

The back panel system status LEDs consist of the System Activity LED, the system Service Required LED, and the Locator LED. These LEDs are located in the top-left corner of the back panel, and operate as described in TABLE 1-1.

## Ethernet Connection LEDs

A set of Ethernet LEDs is located on each Ethernet port. The Ethernet LEDs operate as described in the following table.

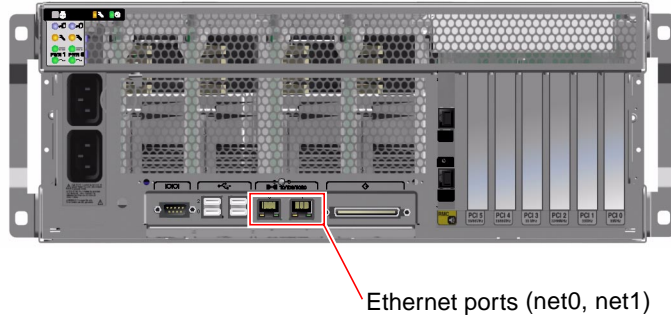

**TABLE 1-5** Ethernet LEDs

Name	Description
Link/Activity	This green LED lights when a link is established at the particular port with its link partner, and blinks to indicate activity.
Speed	This amber LED lights when a Gigabit Ethernet connection is established, and is off when a 10/100-Mbps Ethernet connection is established.

## Power Supply LEDs

Each power supply has a corresponding set of four LEDs on the back panel. These LEDs operate as described in TABLE 1-3.



## Network Management Port LED

The network management port has a Link LED that operates as described in TABLE 1-6.

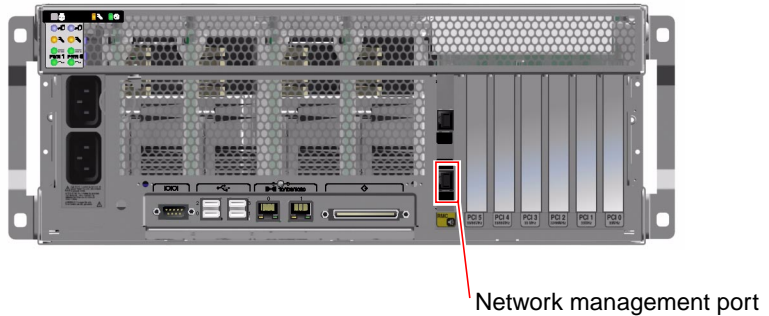

**TABLE 1-6** Network Management Port LED

Name	Description
Link	This green LED is lit when an Ethernet connection is present.

# Back Panel Slots and Ports

The back panel provides access to the PCI slots, external ports, and Advanced Lights Out Manager (ALOM) card ports.

## PCI Slots

The Sun Fire V440 server has three 33-MHz PCI slots and three 66-MHz PCI slots. These are labeled on the back panel. The Advanced Lights Out Manager (ALOM) card is located to the left of the PCI slots.

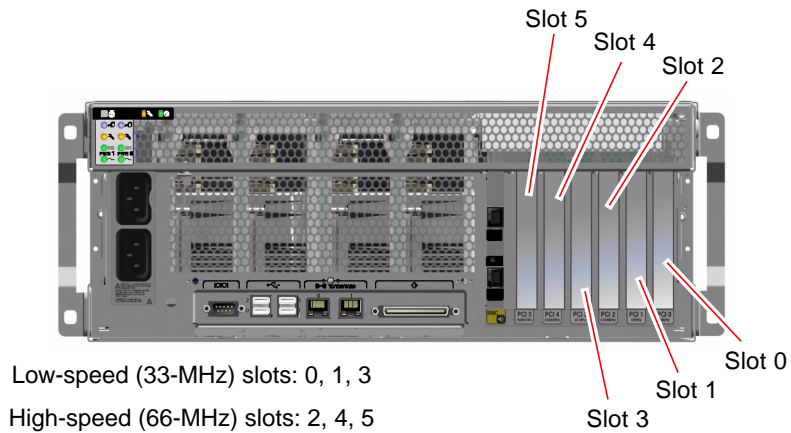



## External Ports

The Sun Fire V440 server has eight external data ports on the back panel, which are described in TABLE 1-7.

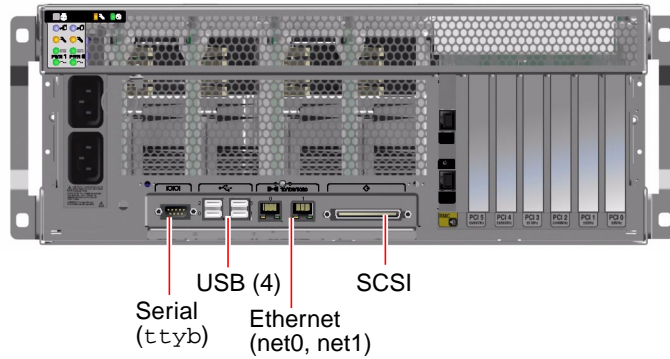





TABLE 1-7 Back Panel External Ports

Icon	Description
	Serial port. The system has one serial port (ttyb) on the back panel, which uses a DB-9 connector.
	Universal Serial Bus (USB) ports. The system has four USB ports (usb0, usb1, usb2, usb3).
	Ethernet ports. The system has two 10/100/1000-Mbps Ethernet ports (net0, net1).
	SCSI connector. The system has one external SCSI 68-pin SCSI connector.

## ALOM Card External Ports

The Advanced Lights Out Manager (ALOM) card has two connectors, which are described in TABLE 1-8.

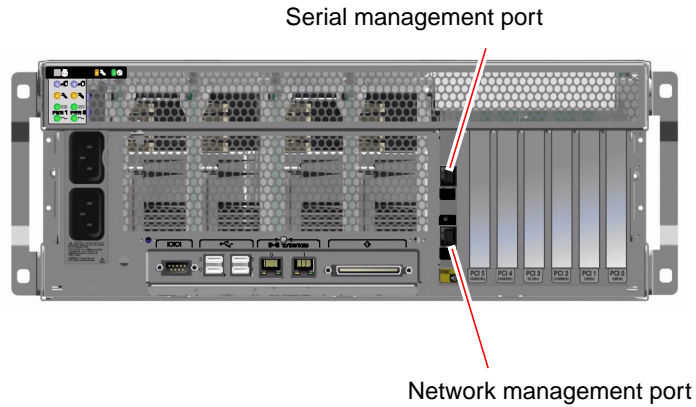

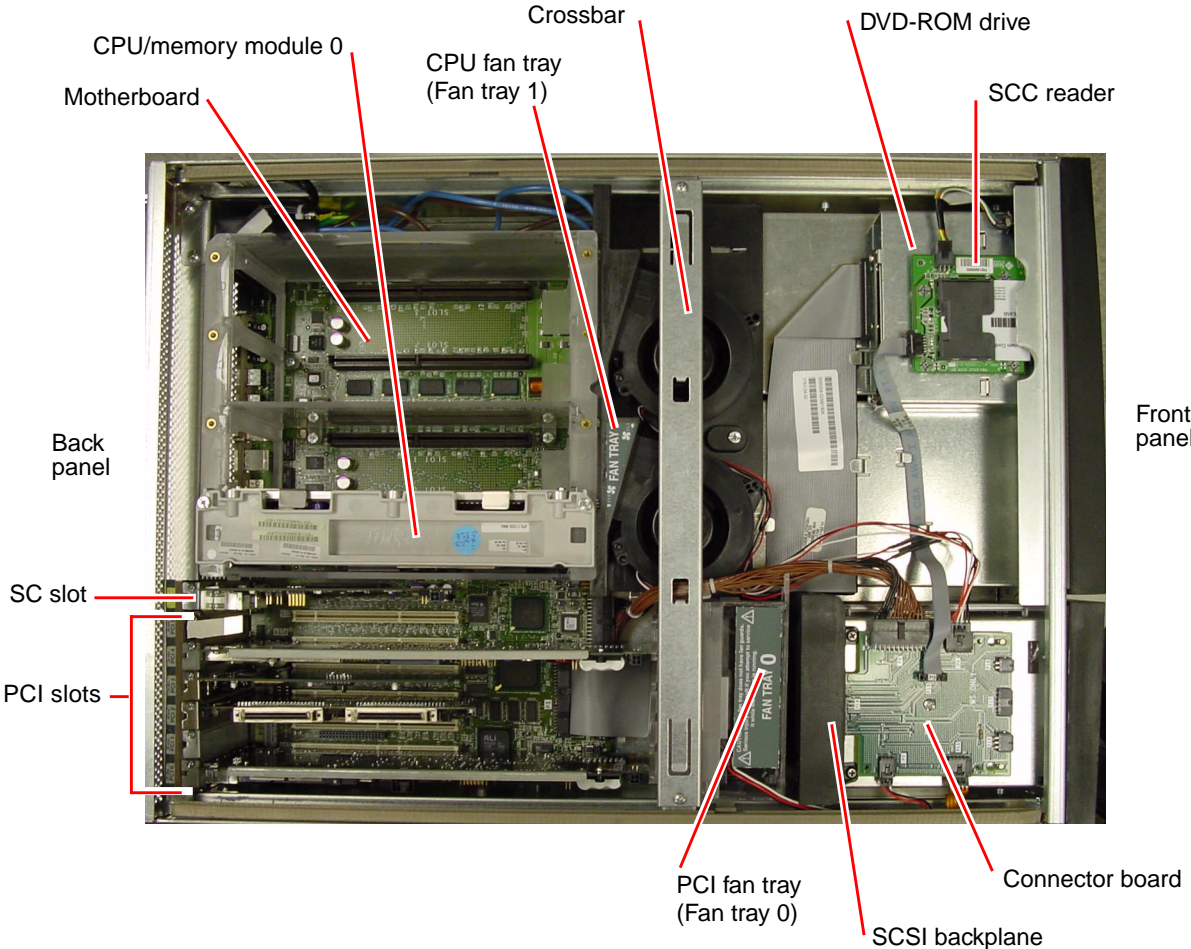

TABLE 1-8 ALOM External Ports

Icon	Description
	Serial (RJ-45) port. This is the default serial management connection for the system.
	Ethernet port. This port provides direct network access to the ALOM card, when configured, and can access the ALOM prompt and system console output.

# Locating Internal Components

The illustration below shows the system's internal components from the top view.





## Preparing to Service the System

---

This chapter contains the following sections:

- “Service Guidelines” on page 18
- “Tools Required for Installation and Service” on page 18
- “How to Power On the System” on page 19
- “How to Power Off the System” on page 23
- “How to Initiate a Reconfiguration Boot” on page 26
- “How to Slide the System Out of the Cabinet” on page 29
- “How to Slide the System Into the Cabinet” on page 32
- “How to Remove the Top Cover” on page 34
- “How to Install the Top Cover” on page 35
- “How to Remove the System From the Cabinet” on page 36
- “How to Install the System Into the Cabinet” on page 39
- “How to Avoid Electrostatic Discharge” on page 44

---

# Service Guidelines

Be sure to keep the following guidelines in mind when servicing the system:

- Except for removing and installing disk drives, the system must be serviced by qualified service providers.
- Only power supplies and disk drives are hot-pluggable. You must power off the system to service any other component.
- You must disconnect the AC power cords when servicing the following components:
  - Motherboard
  - Keypad
  - SCSI backplane
  - Connector board
  - System configuration card (SCC) reader
  - Advanced Lights Out Manager (ALOM) system controller card
- To prevent damaging the system doors while working inside the system, remove the top cover, then close the system doors. Follow this guideline when servicing the following components:
  - CPU/memory module
  - PCI card
  - ALOM card
  - PCI fan tray (Fan tray 0)
  - CPU fan tray (Fan tray 1)
  - Connector board
  - Cables

---

# Tools Required for Installation and Service

The following tools are required to install and service the system:

- Screwdriver, Phillips No. 1
- Screwdriver, Phillips No. 2
- Screwdriver, long Phillips No. 2 (shaft at least 8 inches/120.32 cm long)
- Adjustable wrench
- Electrostatic discharge (ESD) mat, Sun part number 250-1088, or equivalent
- Grounding wrist or foot strap

The latter two items help protect the system against damage due to electrostatic discharge. For more information, see:

- “How to Avoid Electrostatic Discharge” on page 44

---

# How to Power On the System

## Before You Begin

Do not use this power-on procedure if you have just added any new internal option or external storage device, or if you have removed a storage device without replacing it. To power on the system under those circumstances, you must initiate a reconfiguration boot. For those instructions, see:

- “How to Initiate a Reconfiguration Boot” on page 26



---

**Caution** – Never move the system when the system power is on. Movement can cause catastrophic disk drive failure. Always power off the system before moving it.

---



---

**Caution** – Before you power on the system, make sure that the system doors and all panels are properly installed.

---

## What to Do

- 1. Turn on power to any external peripherals and storage devices.**

Read the documentation supplied with the device for specific instructions.

- 2. Establish a connection to the system console.**

If you are powering on the system for the first time, connect a device to the serial management port using one of the methods described in the *Sun Fire V440 Server Administration Guide*. Otherwise, use one of the methods for connecting to the system console, also described in the *Sun Fire V440 Server Administration Guide*

**3. Connect the AC power cords.**

As soon as the AC power cords are connected to the system, the ALOM boots and displays its power-on self-test (POST) messages. Though the system power is still off, the ALOM is up and running, and monitoring the system. Regardless of system power state, as long as the power cords are connected and providing standby power, the ALOM is on and monitoring the system.

**4. Open the right-side system door.**

Insert the system key into the lock and rotate the key counterclockwise.

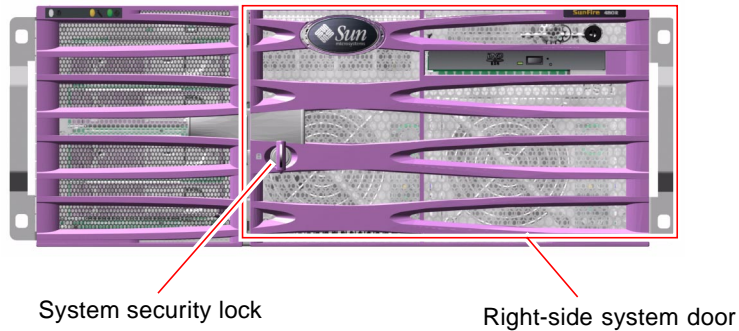

**5. Insert the system key into the system control keyswitch and turn it to the Normal or Diagnostics position.**

See “System Control Keyswitch” on page 7 for information about each system control keyswitch setting.



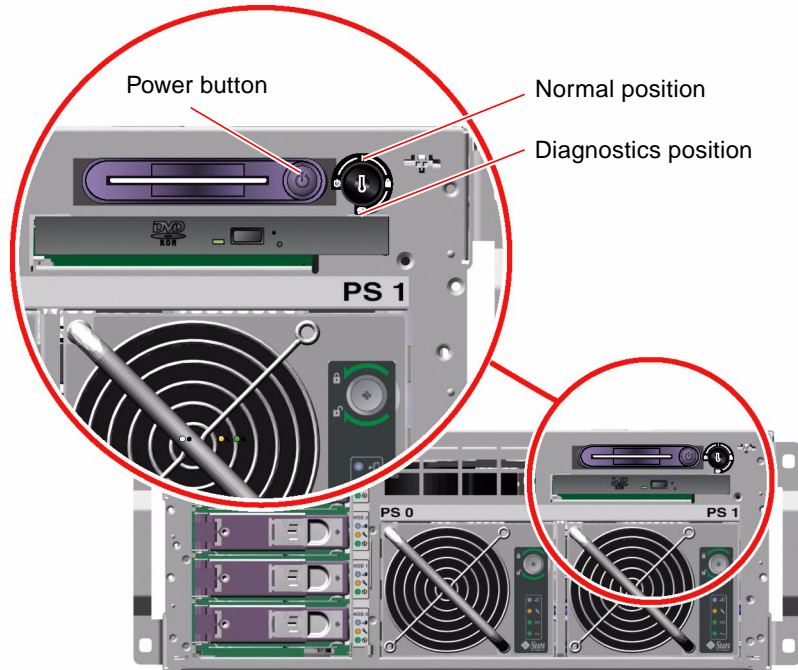

**6. Press the Power button that is to the left of the system control keyswitch to power on the system.**

Output is immediately displayed to the system console if diagnostics are enabled at power-on, and the system console is directed to the serial and network management ports.

The system can take anywhere from 30 seconds to 20 minutes before video is displayed on the system monitor or the ok prompt appears on an attached terminal. This time depends on the system configuration (number of CPUs, memory modules, PCI cards) and the level of power-on self-test (POST) and OpenBoot™ Diagnostics tests being performed.

**7. Turn the system control keyswitch to the Locked position.**

This prevents anyone from accidentally powering off the system.

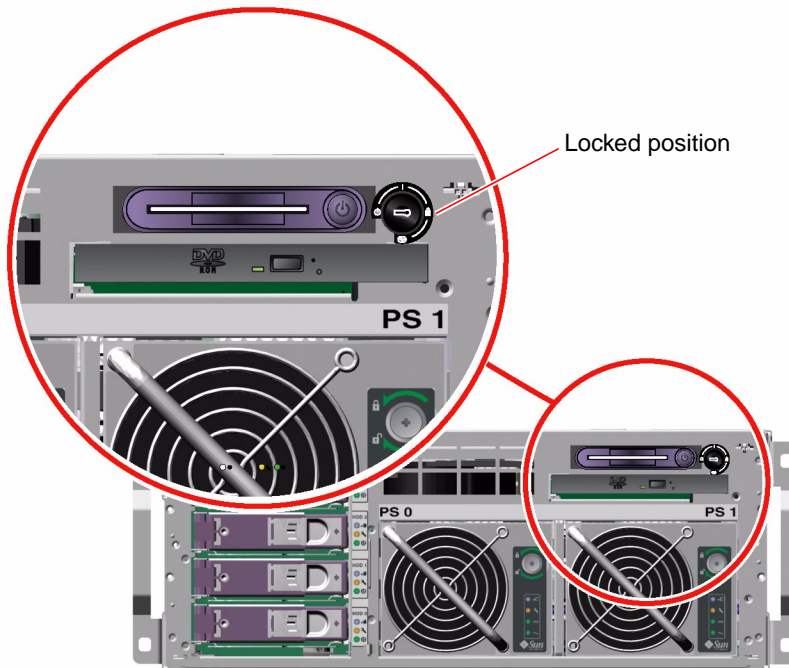

**8. Remove the system key from the system control keyswitch, close and lock the system doors, and keep the key in a secure place.**

If desired, you can close and lock the system doors while the mini-key remains in the system control keyswitch.

## What Next

To power off the system, complete this task:

- “How to Power Off the System” on page 23

---

# How to Power Off the System

## Before You Begin



---

**Caution** – Applications running on the Solaris operating environment can be adversely affected by a poorly executed system shutdown. Ensure that you have gracefully shut down any applications before powering off the system.

---

## What to Do

1. **Notify users that the system will be powered down.**
2. **Back up the system files and data, if necessary.**
3. **Unlock and open the right-side system door.**

4. Ensure that the system control keyswitch is in the Normal or Diagnostics position.

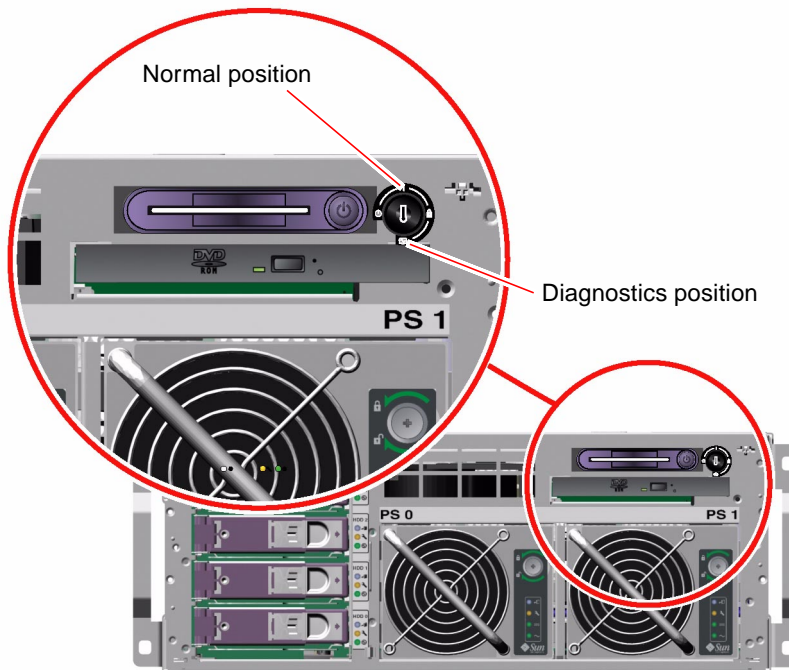

5. Press and release the Power button on the system front panel.

The system begins a graceful software system shutdown.

---

**Note** – Pressing and releasing the Power button initiates a graceful software system shutdown. Pressing and holding in the Power button for four seconds causes an immediate hardware shutdown. Whenever possible, you should use the graceful software shutdown method. Forcing an immediate hardware shutdown can cause disk drive corruption and loss of data. Use that method only as a last resort.

---

**6. Turn the system control keyswitch to the Standby position.**

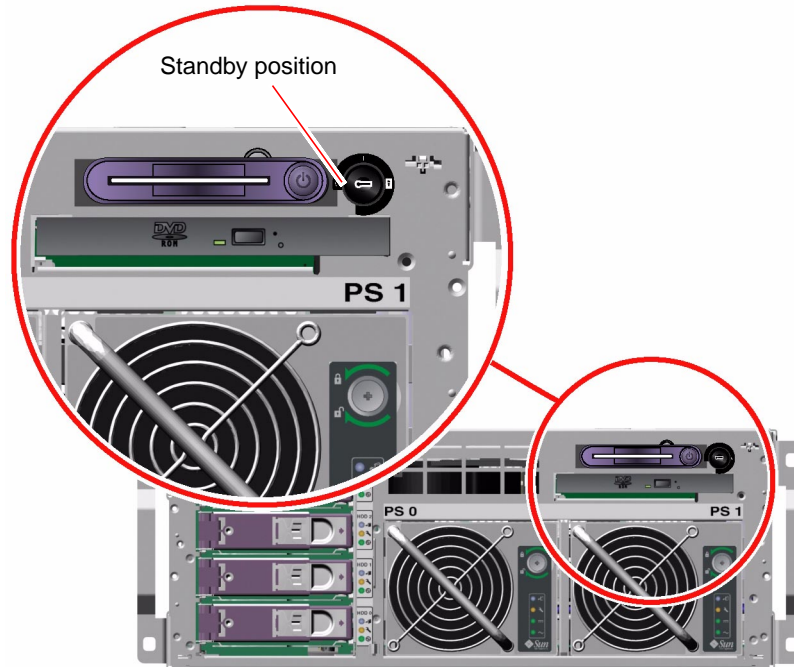

---

**Caution** – Be sure to turn the system control keyswitch to the Standby position before handling any internal components. Otherwise, it is possible for an operator at an ALOM console to restart the system while you are working inside it. The Standby position is the only system control keyswitch position that prevents an ALOM user from restarting the system.

---

**7. Remove the system key from the system control keyswitch, close and lock the system doors, and keep the key in a secure place.**

If desired, you can close and lock the system doors while the mini-key remains in the system control keyswitch.

## What Next

Continue with your parts removal and installation, as needed.

---

# How to Initiate a Reconfiguration Boot

After installing any new internal option or external storage device, you must perform a reconfiguration boot so that the operating system is able to recognize the newly installed device(s). In addition, if you remove any device and do not install a replacement device prior to rebooting the system, you must perform a reconfiguration boot in order for the operating system to recognize the configuration change. This requirement also applies to any component that is connected to the system I<sup>2</sup>C bus, including memory modules, CPU/memory modules, and power supplies.

This requirement *does not* apply to any component that is:

- Installed or removed as part of a hot-plug operation
- Installed or removed before the operating system is installed
- Installed as an identical replacement for a component that is already recognized by the operating system

## Before You Begin



---

**Caution** – Before you power on the system, make sure that the system doors and all panels are properly installed.

---

To issue software commands, you need to set up the system console. This procedure assumes you are accessing the system console using the serial or network management port. For more information, see:

- *Sun Fire V440 Server Administration Guide*

## What to Do

1. **Turn on power to any peripherals and external storage devices.**  
Read the documentation supplied with the device for specific instructions.
2. **Turn on power to the alphanumeric terminal or local graphics monitor, or log in to the ALOM system controller.**

**3. Insert the system key into the system control keyswitch and turn the switch to the Diagnostics position.**

Use the Diagnostics position to run power-on self-test (POST) and OpenBoot Diagnostics tests to verify that the system functions correctly with the new part(s) you just installed. See “System Control Keyswitch” on page 7 for information about system control keyswitch settings.

**4. Press the Power button to the left of the system control keyswitch to power on the system.**

**5. If you are logged into the `sc>` prompt, switch to the `ok` prompt, type:**

```
sc> console
```

**6. When the initializing memory messages appear on the system console, immediately abort the boot process to access the system `ok` prompt.**

The initializing memory messages appear after the system banner is displayed. The system banner contains the Ethernet address and the host ID.

```
Sun Fire V440, No Keyboard
Copyright 1998-2003 Sun Microsystems, Inc. All rights reserved.
OpenBoot 4.10.0.build_03, 8192 MB memory installed, Serial
#02914931.
Ethernet address 0:5:ba:27:f0:4b, Host ID: 8127e54b.

Initializing      1MB of memory at addr      323feca000 -
```

To abort the boot process, use one of the following methods:

- Press the L1-A (Stop-A) keys on your keyboard.
- Press the Break key on the terminal keyboard.

**7. At the `ok` prompt, type the following commands:**

```
ok setenv autoboot? false
ok reset-all
```

You must set the `autoboot?` variable to `false` and issue the `reset-all` command to ensure that the system correctly initializes upon reboot. If you do not issue these commands, the system might fail to initialize, because the boot process was aborted in Step 6.

**8. At the `ok` prompt, type:**

```
ok setenv autoboot? true
```

You must set the `autoboot?` variable back to `true` so that the system boots automatically after a system reset.

**9. At the `ok` prompt, type:**

```
ok boot -r
```

The `boot -r` command rebuilds the device tree for the system, incorporating any newly installed options so that the operating system will recognize them.

---

**Note** – The system can take anywhere from 30 seconds to 20 minutes before the system banner appears. This time depends on the system configuration (number of CPUs, memory modules, PCI cards) and the level of POST and OpenBoot Diagnostics tests being performed.

---

**10. Turn the system control keyswitch to the Locked position.**

This prevents anyone from accidentally powering off the system.

**11. Remove the system key from the system control keyswitch, close and lock the system doors, and keep the key in a secure place.**

You can close and lock the system doors with the mini-key in the system control keyswitch.

## What Next

The system status LED indicators provide power-on status information. For information about the system LEDs, see:

- “Front Panel LEDs” on page 3

If your system encounters a problem during startup, make sure that the system control keyswitch is in the Diagnostics position and power cycle the system. For information about system diagnostics and troubleshooting, see:

- *Sun Fire V440 Server Diagnostics and Troubleshooting Guide*



---

# How to Slide the System Out of the Cabinet

This procedure describes placing the system in position for service by sliding it out of the cabinet without removing it from the rack. All service procedures can be performed while the system is still attached to the rack.

---

**Note** – Sliding the system out of the cabinet is not required for servicing disk drives or power supplies.

---

## Before You Begin



---

**Caution** – Unless the cabinet is bolted to the floor, you must extend the cabinet's anti-tip legs and adjust their stabilizing feet to the floor. You must level and secure the cabinet to provide a safe working environment. See “Tools Required for Installation and Service” on page 18 for tools required for this procedure.

---

## What to Do

1. **Extend and adjust the cabinet's anti-tip legs.**
2. **Open (or remove) the front and back cabinet doors.**
3. **Note each cable's origin and its terminating connection.**
4. **Disconnect all external cables from the back panel of the system.**



---

**Caution** – Do not disconnect the power cords from the system power inlets unless you are installing or replacing the motherboard, the connector board, the SCSI backplane, the system configuration card reader, or the Advanced Lights Out Manager (ALOM) system controller card. The power cords ground the system.

---

**5. Loosen the four captive screws securing the system to the left and right vertical rails at the front of the cabinet.**

Use a Phillips No. 2 screwdriver to loosen the captive screws, which are in recessed access holes in the decorative panels affixed to the system's front panel.

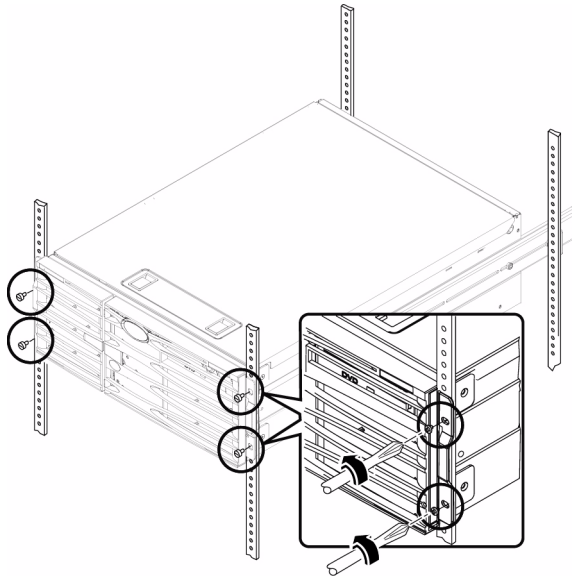

- 6. Slide the system evenly out of the cabinet until the inner glides stop in the slide.**
- Grasp the system's front bezel and pull the system smoothly out of the cabinet. Continue pulling the system until the back of the chassis clears the cabinet and you hear the flat spring catches in the glides engage with an audible clicking sound. The system is then fully extended and secure.

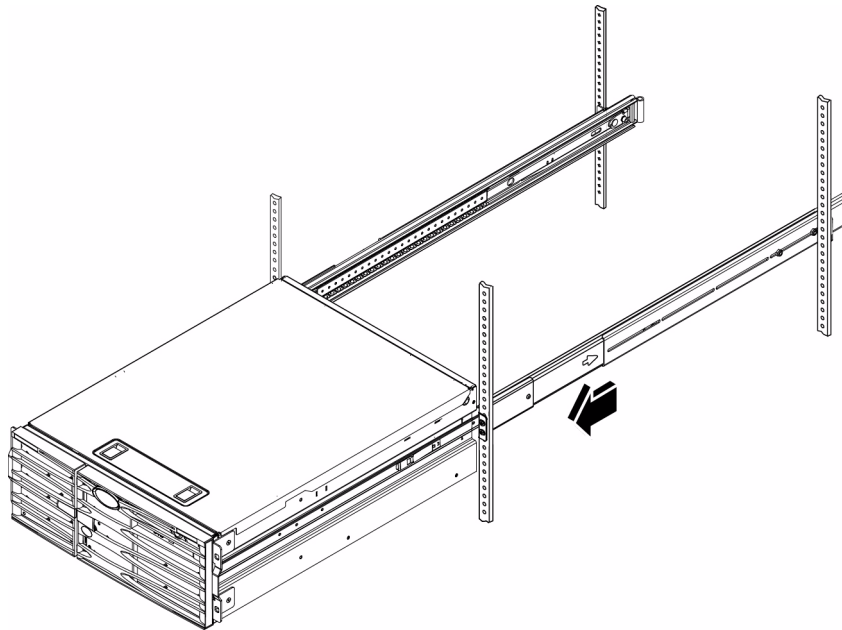

## What Next

To slide the system into the cabinet, see:

- “How to Slide the System Into the Cabinet” on page 32

---

# How to Slide the System Into the Cabinet

## Before You Begin

If you have been working inside the system, see:

- “How to Install the Top Cover” on page 35

## What to Do

- 1. Release the two flat spring catches that lock the system into its current position.**  
Press in on both spring catches to free the system glides. One flat spring catch is attached to each inner glide on the system.
- 2. Slide the system evenly into the cabinet until the system stops moving.**

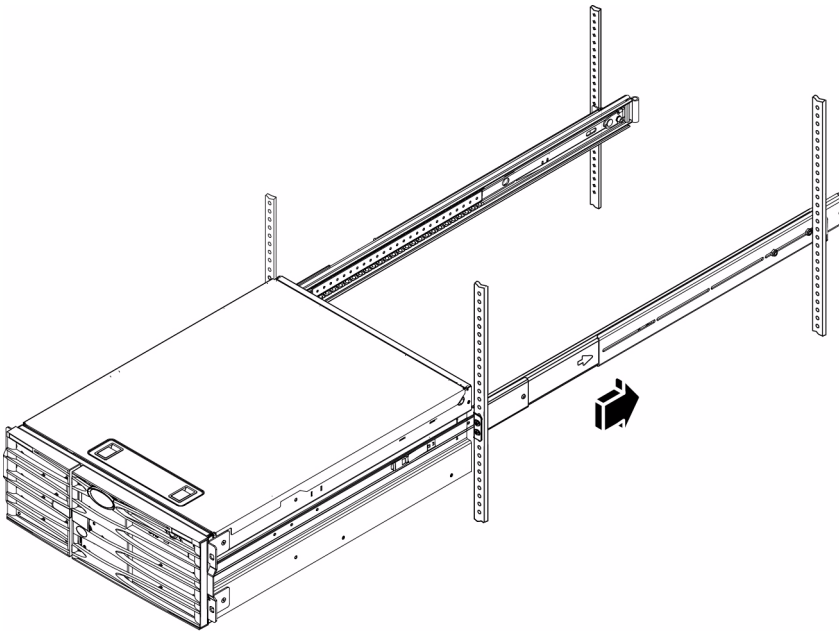

**3. Tighten the four captive screws that secure the system to the left and right vertical rails at the front of the cabinet.**

Use a Phillips No. 2 screwdriver to tighten the four captive screws, which are in recessed access holes in the decorative panels affixed to the system's front panel.

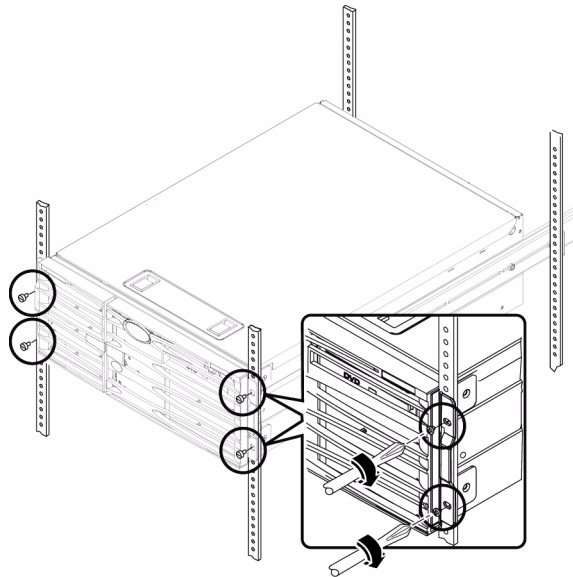

**4. Connect all external cables that were attached to the back panel of the system.**

Examine each cable for information indicating the cable's origin and its terminating connection.

**5. Replace, close, and lock the cabinet doors, as appropriate.**

## What Next

To power on the system, see:

- “How to Power On the System” on page 19

---

# How to Remove the Top Cover

## Before You Begin

Complete these tasks:

- “How to Power Off the System” on page 23
- “How to Slide the System Out of the Cabinet” on page 29

## What to Do

### 1. Open the system doors.

Use the system key to unlock the front doors.

### 2. Loosen the Phillips No. 2 captive lockdown screw securing the top cover to the chassis.

The lockdown screw is located on the chassis face above the disk drives.

### 3. Pull the latches up to release the top cover from the chassis, then lift the cover up and off the chassis.

## What Next

To replace the top cover, see:

- “How to Install the Top Cover” on page 35

---

# How to Install the Top Cover

## Before You Begin

Complete this task:

- “How to Remove the Top Cover” on page 34

## What to Do

- 1. Insert the back edge of the top cover under the lip on the back panel.**
- 2. Grasp the latches and lower the top cover onto the chassis.**
- 3. Release the latches when the top cover is seated on the chassis.**
- 4. Verify that the latches are engaged by gently pulling up on the sides of the top cover.**
- 5. Tighten the Phillips No. 2 captive lockdown screw that secures the top cover to the chassis.**

The lockdown screw is located on the chassis face above the disk drives.

- 6. Close and lock the system doors.**

## What Next

To power on the system, see:

- “How to Slide the System Into the Cabinet” on page 32
- “How to Power On the System” on page 19

---

# How to Remove the System From the Cabinet

You can perform all service procedures while the system is still attached to the rails extended from the cabinet. If you want to remove the system from the cabinet for any other reason, follow the instructions in this section.



---

**Caution** – The system is heavy. Two persons are required to remove the system from the cabinet in the following procedure.

---

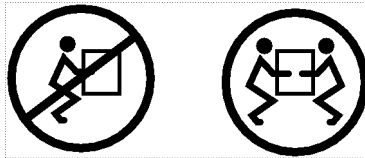

## Before You Begin

Complete these tasks:

- Identify a helper to assist you in removing the system.
- Verify that your helper can safely lift and carry 40 lb (18 kg), which is approximately half the weight of a fully equipped system.
- Review the steps in the next section with your helper and discuss how to coordinate your efforts to ensure your mutual safety.
- Assemble the correct tools for the procedure. See “Tools Required for Installation and Service” on page 18.
- Turn off system power. See “How to Power Off the System” on page 23.
- Open and remove the cabinet front door and back door.



---

**Caution** – When completing a two-person procedure, always communicate your intentions clearly before, during, and after each step to minimize confusion.

---



# What to Do

1. **Disconnect all external cables from the back panel of the system.**  
Note each cable's origin and its terminating connection.
2. **Disconnect the cable management arm from the system, if applicable.**
3. **Extend the cabinet's anti-tip legs.**



---

**Caution** – Unless the cabinet is bolted to the floor, you must extend the cabinet's anti-tip legs and adjust their stabilizing feet to the floor. Level and secure the cabinet to provide a safe working environment. See “Tools Required for Installation and Service” on page 18 for tools required for this procedure.

---

4. **Remove the four M4, M6, or 10-32 screws securing the system to the front mounting rails.**

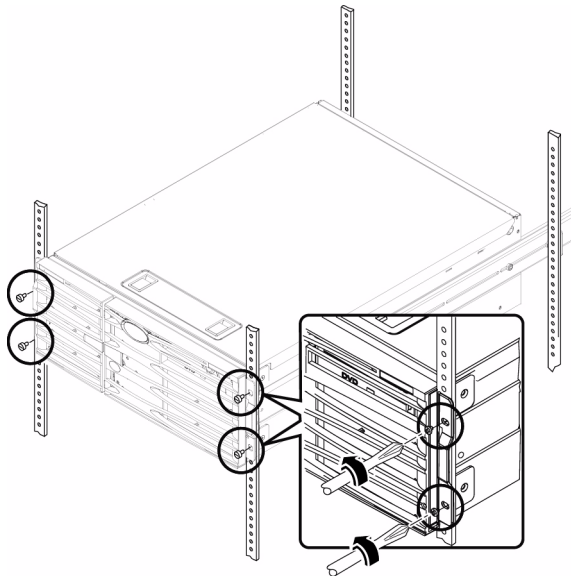

5. **Extend the system from the cabinet, and then position one person on each side of the system, facing the system glides.**

When you are both in position, verify that your helper understands what to do with the system after you release the server and remove it. Also agree on a route to follow, and visually inspect it for potential safety hazards (for example, cables on the floor, other people working in the vicinity, and so on).

6. **Locate the flat spring catches.**

Each person should visually locate one of the two flat spring catches that release the system from the slide assemblies. One catch is attached to each inner glide.

7. **Prepare to remove the system.**

Each person should place one hand on the flat spring catch and the other hand beneath the system, palm up, ready to support the weight of the system.

8. **Simultaneously press in on both flat spring catches to release them, and then slide the system out of the slide assemblies.**

Each person presses one flat spring catch and helps slide the system free of the slide assemblies, supporting the weight of the system with both hands as the system slides free of the cabinet.

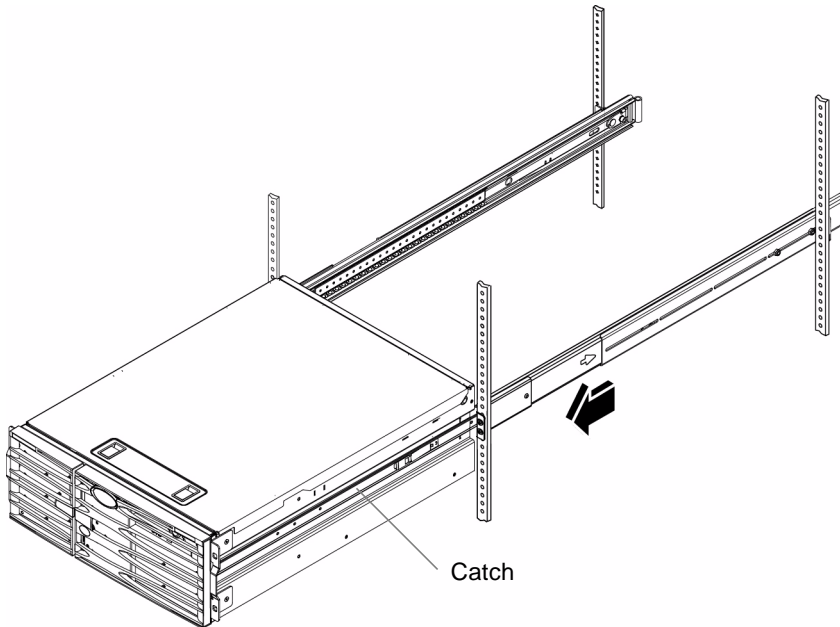

9. **Set the system on a workbench or other stable surface.**

10. Push the empty slides back into their protective slide assemblies.
11. Replace, close, and lock the cabinet doors, as appropriate.

## What Next

To install the system into the cabinet, see:

- “How to Install the System Into the Cabinet” on page 39

---

# How to Install the System Into the Cabinet

This procedure assumes that the slide assemblies are already installed in the cabinet. For information about installing the slide assemblies, see:

- *Sun Fire V440 Server Installation Guide*



---

**Caution** – The system is heavy. Two persons are required to install the system into the cabinet.

---

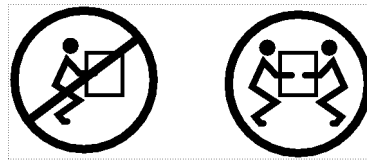

## Before You Begin

Complete the following tasks:

- Identify a helper to assist you in installing the system.
- Open and remove the front door and back door of the cabinet, as appropriate.



---

**Caution** – Before you install the system into the cabinet, make sure that the cabinet is stabilized so that it cannot move or tip forward. See the cabinet documentation for information about stabilizing the cabinet.

---

---

**Note** – Make sure that each slide assembly is fully retracted into the rack and check that the ball-bearing runner on each slide assembly is all the way forward.

---

## What to Do

1. **With one person on each side of the server, lift the server and approach the cabinet with the back of the server facing the front of the cabinet.**

---

**Note** – Do *not* use the vent holes in the server doors as “handles” to lift the server.

---

2. **Align the rounded ends of the inner glides on the system with the slide assemblies in the cabinet.**

---

**Note** – Make sure that the inner glides attached to the system are inserted within the ball-bearing runners.

---

3. Holding the system level, slide it evenly all the way into the cabinet until the inner glides stop.

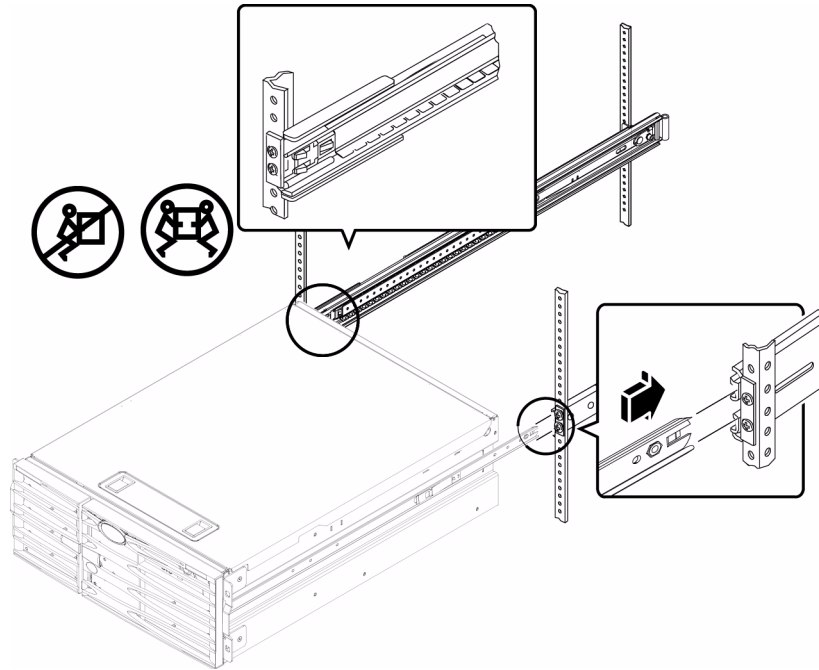

---

**Tip** – Slide the server in and out of the cabinet slowly and carefully to ensure that the slide assemblies are working correctly and are free from obstructions.

---

4. Press the catch on each inner glide in order to slide the server all the way back into the cabinet.

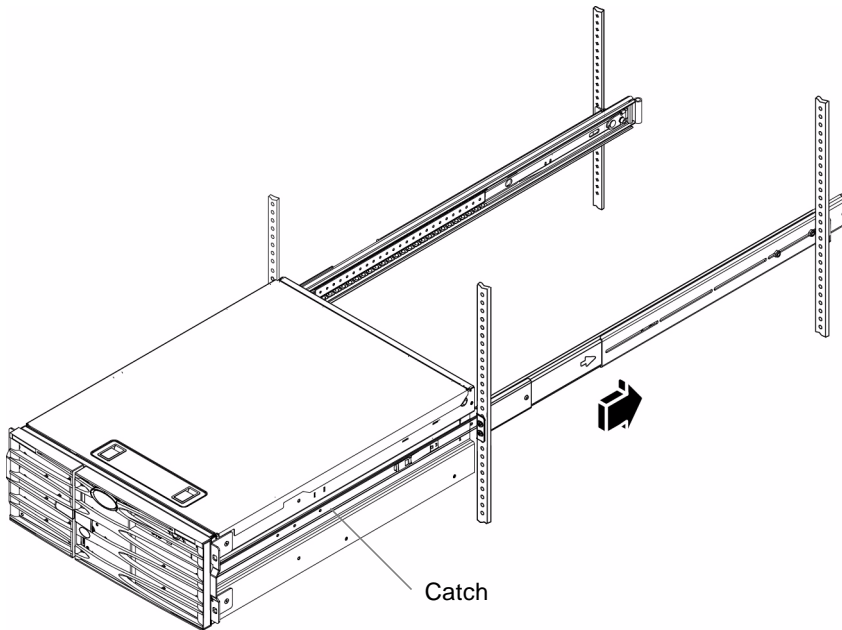

5. Slide the system evenly into the cabinet until the system stops moving.

6. **Secure the system to the front rails using four M4, M6, or 10-32 screws, depending on your cabinet, to attach the chassis brackets to the rack.**

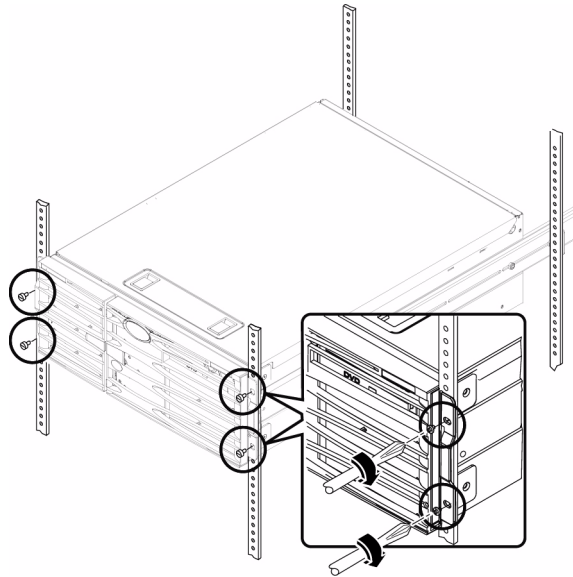

7. **Attach the cable management arm to the system, if applicable.**  
Route the cables through the cable management arm.
8. **Connect all external cables that were attached to the back panel of the system.**  
Examine each disconnected cable for information indicating the cable's origin and its terminating connection.
9. **Replace, close, and lock the cabinet doors, as appropriate.**

## What Next

To power on the system, see:

- “How to Power On the System” on page 19

---

## How to Avoid Electrostatic Discharge

Use the following procedure to prevent static damage whenever you are accessing any of the internal components of the system.

### Before You Begin

Complete these tasks:

- “How to Power Off the System” on page 23
- “How to Slide the System Out of the Cabinet” on page 29

If you are servicing any internal components, complete this task:

- “How to Remove the Top Cover” on page 34

You must have the following items:

- Antistatic wrist or foot strap
- Antistatic mat (or the equivalent)

### What to Do



---

**Caution** – Printed circuit boards and hard disk drives contain electronic components that are extremely sensitive to static electricity. Ordinary amounts of static from your clothes or the work environment can destroy components. Do not touch the components or any metal parts without taking proper antistatic precautions.

---

#### 1. Disconnect the AC power cords only when performing the following procedures:

- Removing and replacing the motherboard
- Removing and replacing the SCSI backplane
- Removing and replacing the system configuration card reader
- Removing and replacing the keyswitch



- Removing and replacing the connector board
- Removing and replacing the Advanced Lights Out Manager (ALOM) card

The AC power cords provide a discharge path for static electricity, so they should remain plugged in except when you are servicing the parts noted above.

## 2. Use an antistatic mat or similar surface.

When performing any installation or service procedure, place static-sensitive parts, such as boards, cards, and disk drives, on an antistatic surface. The following items can be used as an antistatic surface:

- The bag used to wrap a Sun replacement part
- The shipping container used to package a Sun replacement part
- Sun electrostatic discharge (ESD) mat, Sun part number 250-1088 (available through your Sun sales representatives)
- Disposable ESD mat, shipped with replacement parts or options

## 3. Use an antistatic wrist strap.

Attach the appropriate end of the strap to the system chassis sheet metal and attach the other end of the strap to your wrist. Refer to the instructions that come with the strap.

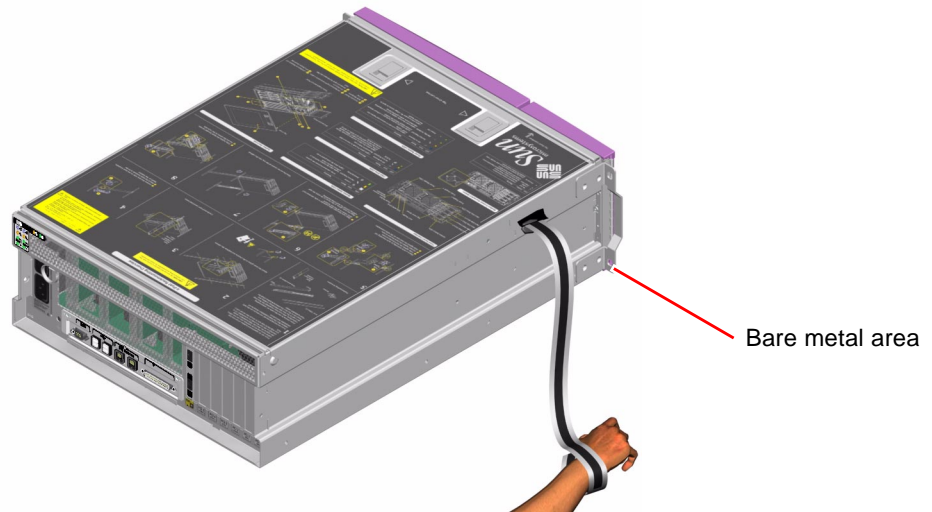

---

**Note** – Make sure that the wrist strap is in direct contact with the metal on the chassis.

---

## 4. Detach both ends of the strap after you have completed the installation or service procedure.

## What Next

To reassemble the system, see:

- “How to Install the Top Cover” on page 35

## Servicing the Front Panel Removable Devices

---

This chapter contains the following sections:

- “About Hot-Pluggable Components” on page 48
- “How to Remove a Power Supply” on page 48
- “How to Install a Power Supply” on page 51
- “How to Remove a Power Supply Using the Hot-Plug Operation” on page 52
- “How to Install a Power Supply Using the Hot-Plug Operation” on page 55
- “How to Remove a Disk Drive” on page 57
- “How to Install a Disk Drive” on page 60
- “How to Remove a Disk Drive Using the Hot-Plug Operation” on page 62
- “How to Install a Disk Drive Using the Hot-Plug Operation” on page 64

---

# About Hot-Pluggable Components

In a Sun Fire V440 server, the SCSI hard disk drives and power supplies are *hot-pluggable* components. No other component of the system is hot-pluggable. Hot-pluggable components are those that you can install or remove while the system is running, without affecting the rest of the system's capabilities. However, you must prepare the operating system prior to the hot-plug operation by performing certain system administration tasks.

For information about performing a hot-plug operation on a mirrored disk, see:

- *Sun Fire V440 Server Administration Guide*

For more information, see the following:

- “How to Remove a Power Supply Using the Hot-Plug Operation” on page 52
- “How to Install a Power Supply Using the Hot-Plug Operation” on page 55
- “How to Remove a Disk Drive Using the Hot-Plug Operation” on page 62
- “How to Install a Disk Drive Using the Hot-Plug Operation” on page 64

---

# How to Remove a Power Supply

This procedure describes the physical power supply removal. The procedure is different if you are removing a power supply using the hot-plug operation. If you want to perform a hot-plug removal, see:

- “How to Remove a Power Supply Using the Hot-Plug Operation” on page 52

## Before You Begin

If a power supply fails, the system status Service Required LED and the power supply Service Required LED will light.

Complete these tasks:

- “How to Power Off the System” on page 23
- “How to Avoid Electrostatic Discharge” on page 44

# What to Do



---

**Caution** – If a power supply fails and you do not have a replacement available, leave the failed power supply installed to ensure proper system cooling.

---

1. **Unlock and open the system doors.**
2. **Identify the power supply to be removed.**

Check the power supply LEDs to determine which power supply is faulty. Before continuing, make sure that the blue OK-to-Remove LED is lit on the power supply you want to remove. For more information, see “Power Supply LEDs” on page 11 and the *Sun Fire V440 Server Administration Guide*.

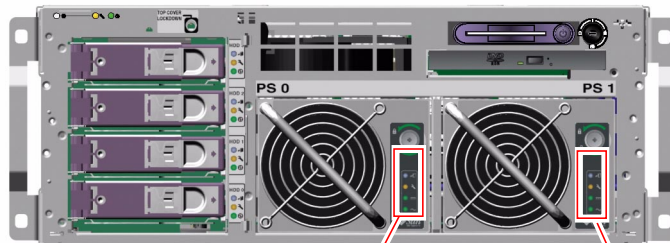

Power supply 0 LEDs

Power supply 1 LEDs

3. Loosen the Phillips No. 2 captive screw that secures the power supply to the chassis.

Turn the screw until it stops to loosen it completely.

4. Pull out the power supply in a smooth motion until it is free of the bay.  
Support the power supply from underneath as you pull the unit out of the bay.

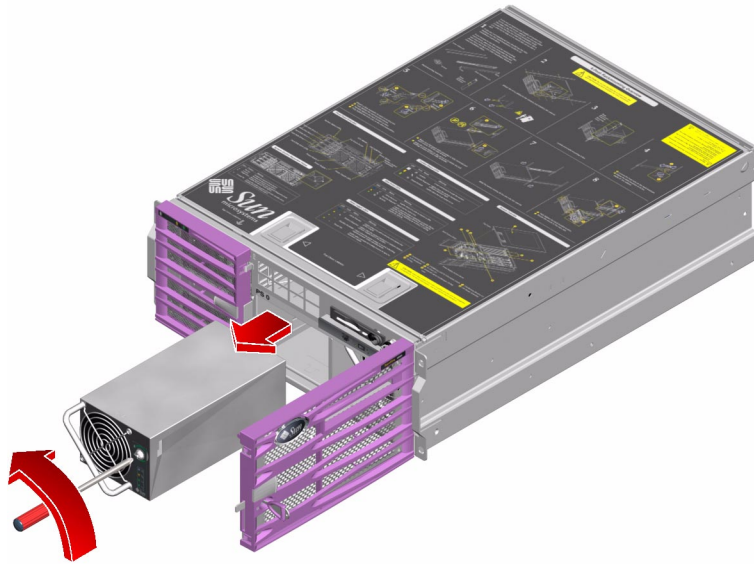

---

**Caution** – Never insert your hand into the power supply bay while the system is running or while the system is connected to AC power. Doing so could result in serious personal injury.

---

## What Next

To reassemble the system, complete this task:

- “How to Install a Power Supply” on page 51

---

# How to Install a Power Supply

## Before You Begin

Complete this task:

- “How to Remove a Power Supply” on page 48

## What to Do

- 1. Make sure that the Phillips No. 2 captive screw on the new power supply is completely unlocked.**  
Turn the screw counterclockwise until the side locking lever is fully contained in the power supply.
- 2. Align the new power supply with its bay.**
- 3. Slide the new power supply into the power supply bay until the power supply connectors start to engage the connectors on the motherboard.**

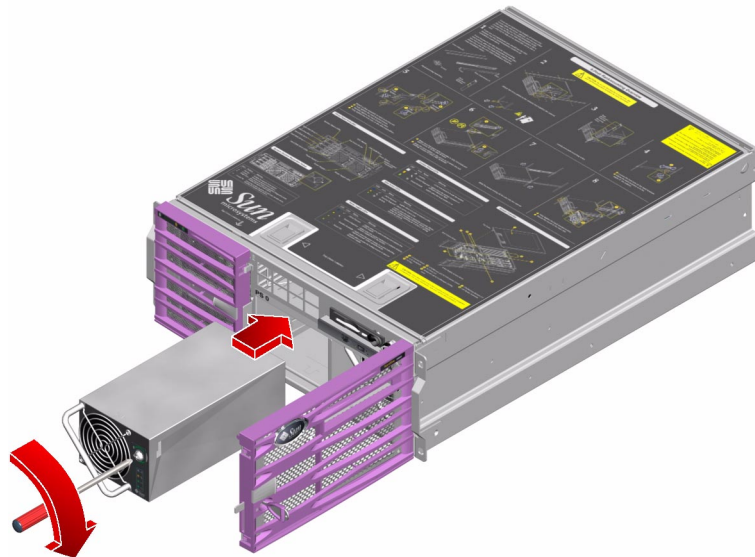

**4. Push firmly on the front of the power supply to engage the power supply connectors with the motherboard connectors.**

Make sure that the power supply is fully seated by aligning the front of the power supply with the scribe line on the bottom of the power supply bay.

**5. Tighten the Phillips No. 2 captive screw to secure the power supply to the chassis.**

Turn the screw until it stops to tighten it completely.

## What Next

Complete this task:

- “How to Power On the System” on page 19

Verify that the power supply is operating correctly. Check the Service Required, Standby Available, and Power OK LEDs on the power supply. You should hear the power supply fan start spinning and the two green LEDs should light within three seconds after restoring power to the system. For more information about the power supply LEDs, see:

- “Power Supply LEDs” on page 6

To reassemble the system, close and lock the system doors.

---

## How to Remove a Power Supply Using the Hot-Plug Operation

The system’s power supply hot-plug feature enables you to remove a power supply without shutting down the operating system or turning off the system power, provided that the other power supply is online, working, and properly secured.

When removing a power supply using the hot-plug operation, you need to issue a software command to prepare the system for the hot-plug operation. This command will also light the power supply OK-to-Remove LED.

Use the Advanced Lights Out Manager (ALOM) software tool to initiate a hot-plug operation of the Sun Fire V440 server’s power supply.

The following procedure assumes that you are accessing the system console by the default method of connecting to the serial management port (SERIAL MGT) of the Sun Fire V440 server.



# Before You Begin

If a power supply fails, the system status Service Required LED and that power supply Service Required LED will light.



---

**Caution** – If a power supply fails and you do not have a replacement available, leave the failed power supply installed to ensure proper system cooling.

---



---

**Caution** – Attempting to remove a power supply without issuing a software command to isolate it could damage the power supply.

---

---

**Note** – You have limited time to perform the power supply hot-plug operation. You have 10 minutes at sea level and a maximum of 7 minutes at 10,000 feet (3048 meters) to ensure proper system cooling.

---

Complete this task:

- “How to Avoid Electrostatic Discharge” on page 44

## What to Do

1. **Unlock and open the system doors.**
2. **Identify the power supply to be removed.**

Check the power supply LEDs to determine which power supply is faulty. For more information, see “Power Supply LEDs” on page 11 and the *Sun Fire V440 Server Administration Guide*.

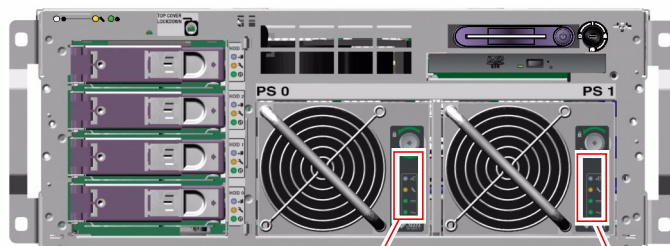

Power supply 0 LEDs

Power supply 1 LEDs

3. To access the ALOM system controller prompt, type the ALOM system controller escape sequence (#.).
4. Type the following ALOM command:

```
sc> removefru PS1
```

where **PS1** is the name of the power supply to be removed. The power supplies are named **PS0** and **PS1**.

The OK-to-Remove LED will light on power supply **PS1**.



---

**Caution** – Do not remove a power supply from a running system until the power supply OK-to-Remove LED is lit.

---

5. **Physically remove the power supply from the system.**

Follow Step 3 and Step 4 of “How to Remove a Power Supply” on page 48.

The system console displays a message confirming the removal of the power supply.

## What Next

To install a power supply using the hot-plug operation, see:

- “How to Install a Power Supply Using the Hot-Plug Operation” on page 55

---

# How to Install a Power Supply Using the Hot-Plug Operation

The system’s power supply hot-plug feature enables you to insert a power supply without shutting down the operating system or turning off the system power.

When installing a power supply, you must insert the power supply and wait for the two green power supply LEDs to light.

The following procedure assumes that you are accessing the system console by the default method of connecting to the serial management port (SERIAL MGT) of the Sun Fire V440 server.

## Before You Begin

---

**Note** – You have limited time to perform a power supply hot-plug operation. You have 10 minutes at sea level and a maximum of 7 minutes at 10,000 feet (3048 meters) to ensure proper system cooling.

---

Complete this task:

- “How to Remove a Power Supply Using the Hot-Plug Operation” on page 52

## What to Do

- 1. Make sure that the Phillips No. 2 captive screw on the new power supply is completely unlocked.**

Turn the screw counterclockwise until the side locking lever is fully contained in the power supply.

- 2. Align the new power supply with its bay.**

3. Slide the new power supply into the power supply bay until the power supply connectors start to engage the connectors on the motherboard.

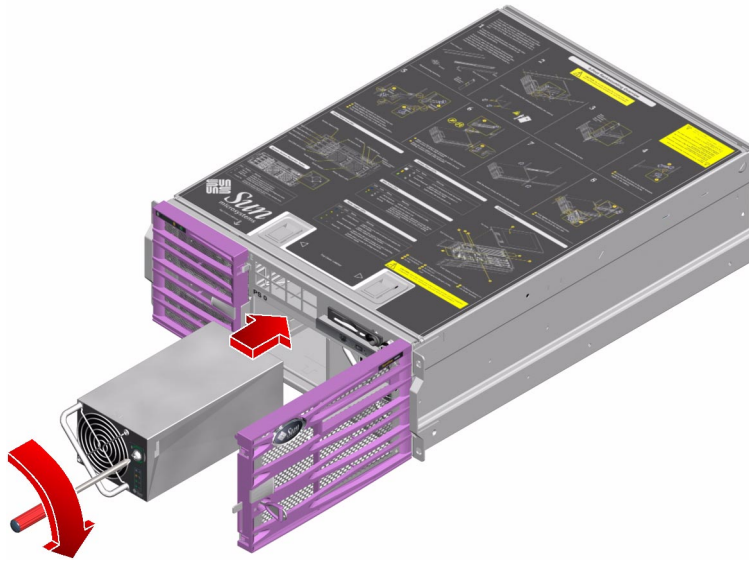

4. **Push firmly on the front of the power supply to engage the power supply connectors with the motherboard connectors.**  
Make sure that the power supply is fully seated by aligning the front of the power supply with the scribe line on the bottom of the power supply bay.
5. **Tighten the Phillips No. 2 captive screw to secure the power supply to the chassis.**  
Turn the screw until it stops to tighten it completely.

## What Next

Verify that the power supply is operating correctly. Check the Service Required, Standby Available, and Power OK LEDs on the power supply. You should hear the power supply fan start spinning and the two green LEDs should light within three seconds after completing a hot-plug installation. For more information about the power supply LEDs, see:

- “Power Supply LEDs” on page 6

To reassemble the system, close and lock the system doors.

---

# How to Remove a Disk Drive

This procedure describes the physical disk drive removal. The procedure is different if you are removing a drive using the hot-plug operation. If you want to perform a disk drive hot-plug removal, see:

- “How to Remove a Disk Drive Using the Hot-Plug Operation” on page 62

## Before You Begin

If a disk drive fails, the system status Service Required LED will light and a console message indicates which disk drive failed. For more information about the disk drives and managing disk drive arrays, see:

- *Sun Fire V440 Server Administration Guide*

You must follow antistatic precautions when handling a disk drive.

Complete these tasks:

- “How to Power Off the System” on page 23
- “How to Avoid Electrostatic Discharge” on page 44

## What to Do

1. **Unlock and open the system doors.**
2. **Identify the disk drive to be removed and note the bay in which it is installed.**

See the *Sun Fire V440 Server Diagnostics and Troubleshooting Guide* for more information about isolating failed parts.

---

**Note** – The lower bay is the default system disk location.

---

3. Pinch the disk drive latch sideways to release the disk drive handle.
4. Pull the handle away from the disk drive until you feel the disk drive connector disengage from the SCSI backplane connector.

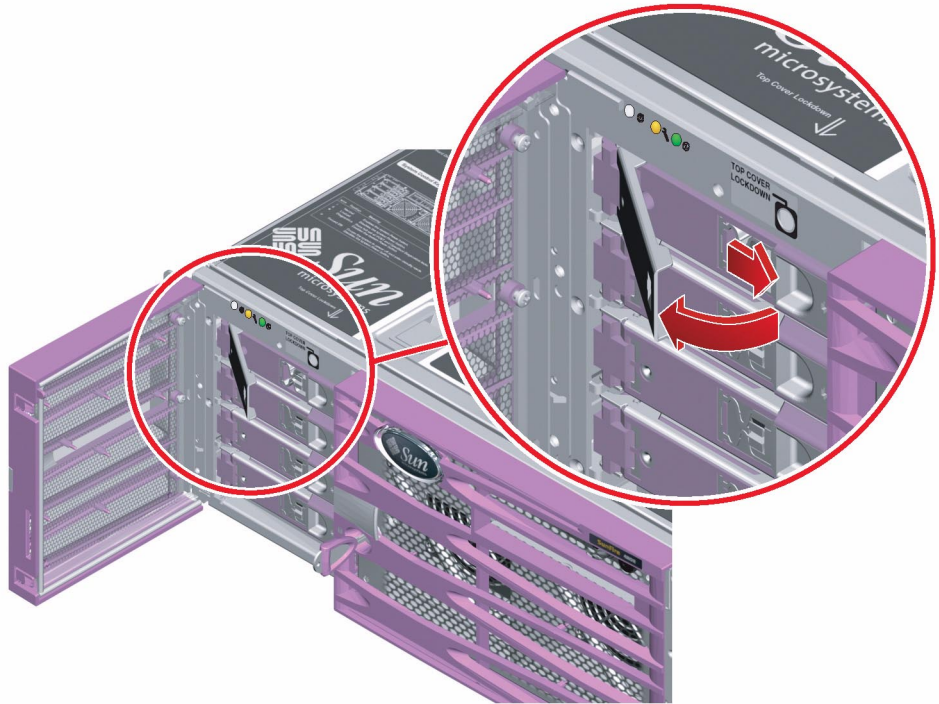

5. Holding the disk drive by the handle, slide the disk drive out of the disk drive bay.

---

**Note** – When you reinstall the disk drive (or a replacement drive), be sure to install the disk drive into the same drive bay as the one from which it was just removed.

---

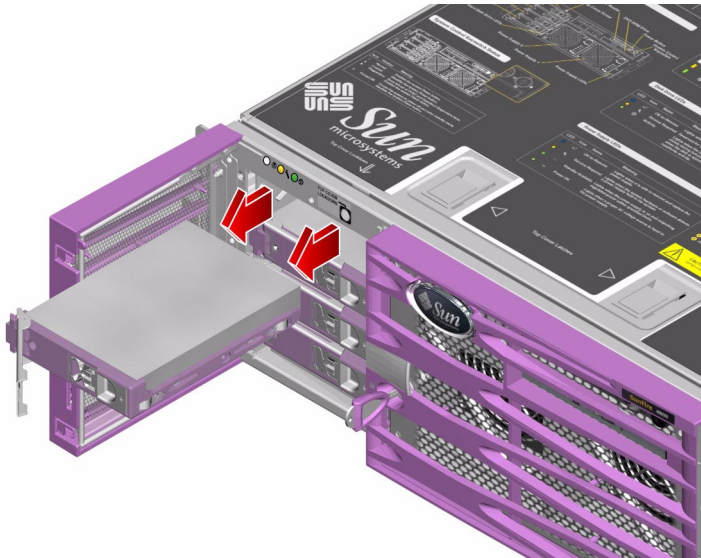

6. Close and lock the system doors.

## What Next

To install a disk drive, complete this task:

- “How to Install a Disk Drive” on page 60

---

# How to Install a Disk Drive

This procedure describes the physical installation of a disk drive. The procedure is different if you are installing a drive using the hot-plug operation. If you want to perform a disk drive hot-plug installation, see:

- “How to Install a Disk Drive Using the Hot-Plug Operation” on page 64

## Before You Begin

For additional information about internal disk drives and configuring disk drive arrays, see:

- *Sun Fire V440 Server Administration Guide*

Complete these tasks:

- “How to Power Off the System” on page 23
- “How to Avoid Electrostatic Discharge” on page 44

## What to Do

- 1. Unlock and open the system doors.**
- 2. Release the disk drive handle on the disk drive.**  
Pinch the disk drive latch sideways to open the handle.
- 3. Align the disk drive to its drive bay.**  
Orient the disk drive so that the disk drive latch is on the right.

---

**Note** – If you are replacing a drive that you removed previously, be sure to install the disk drive into the same drive bay from which it was removed.

---



**4. Insert the disk drive into the disk drive bay guide rails.**

Slide the disk drive into the bay until it barely contacts the backplane.

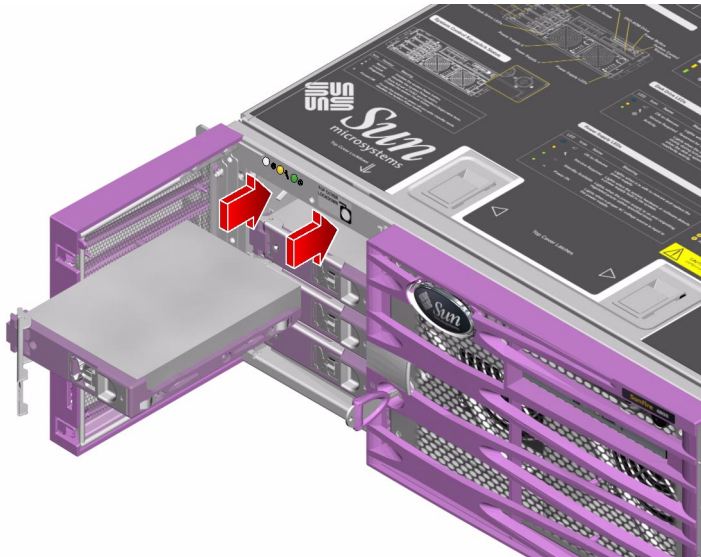

**5. Firmly press the center of the disk drive handle toward the disk drive until the latch closes, securing the disk drive in place.**

**6. Close and lock the system doors.**

## What Next

Complete this task:

- “How to Power On the System” on page 19

---

# How to Remove a Disk Drive Using the Hot-Plug Operation

The system's disk hot-plug feature enables you to remove a disk drive without shutting down the operating system or turning off the system power. The way in which you remove a disk drive depends on the application you are using and whether you are replacing a drive, adding a new one, or removing a drive permanently.

When you remove a drive using the hot-plug operation, you need to stop the disk drive and take it offline to remove the logical software links to the disk drive, and to reconfigure the file systems so that they now ignore the removed drive. You might also have to reconfigure your application software to operate without the removed drive.

Use the `cfgadm` command to remove a Sun Fire V440 server's internal disk drive using the hot-plug operation. The following procedure describes the general steps involved, but your specific device names might be different.

The following procedure assumes that you are accessing the system console by the default method of connecting to the serial management port (SERIAL MGT) of the Sun Fire V440 server.



---

**Caution** – Do not hot-plug drives without the correct preparations. The system supports hot-plugging disk drives, but you must issue a software command before you remove or install a disk drive.

---

## Before You Begin

If a disk drive fails, the system status Service Required LED will light and a console message will indicate which disk drive failed.

If you have not configured the system with two boot disks, you cannot hot-plug a single boot disk. You can only hot-plug the boot disk when you have configured a two-disk mirror of the boot disk for hot-plugging. If the system is configured with a boot disk and data disks, you can hot-plug the data disks, but not the boot disk. For more information on disk mirroring, see:

- *Sun Fire V440 Server Administration Guide*

Complete these tasks:

- Obtain the logical device name(s) for the device(s) you plan to remove. See the *Sun Fire V440 Server Administration Guide* for more information.
- Select the disk and stop any activity or applications accessing the disk drive.
- Unmount any file systems mounted on the disk drive.
- Perform “How to Avoid Electrostatic Discharge” on page 44.

## What to Do

### 1. Log in as superuser or root user:

```
% su
Password:
#
```

### 2. Remove the disk drive from the device tree using the following command:

```
# cfgadm -x unconfigure /dev/rdisk/c0t0d0
```

where *c0t0d0* is the name of the disk drive to be removed.

The blue OK-to-Remove disk drive LED lights.

### 3. Allow the disk to spin down completely.

### 4. Physically remove the disk drive from the system.

Follow Step 1 through Step 6 of the procedure, “How to Remove a Disk Drive” on page 57.

## What Next

To install a disk drive using the hot-plug operation, complete this task:

- “How to Install a Disk Drive Using the Hot-Plug Operation” on page 64

---

# How to Install a Disk Drive Using the Hot-Plug Operation

The system's disk hot-plug feature enables you to insert a disk drive without shutting down the operating system or turning off the system power. When installing a disk, you must insert the disk drive and wait for it to spin up to operating speed. Then you re-create or reconfigure the file systems so that the Solaris environment recognizes the disk drive. Finally, you configure your application (if necessary) to operate with this new drive.

Use the `cfgadm` command to install a Sun Fire V440 server's internal disk drives using the hot-plug operation. The following procedure describes the general steps involved, but your specific device names might be different.

The following procedure assumes that you are accessing the system console by the default method of connecting to the serial management port (SERIAL MGT) of the Sun Fire V440 server.



---

**Caution** – Do not hot-plug drives without the correct preparations. The system supports hot-plugging disk drives, but you must issue a software command before you remove or install a disk drive.

---

## Before You Begin

If you have not configured the system with two boot disks, you cannot hot-plug a single boot disk. You can only hot-plug the boot disk when you have configured a two-disk mirror of the boot disk for hot-plugging. If the system is configured with a boot disk and data disks, you can hot-plug the data disks, but not the boot disk. For more information on disk mirroring, see:

- *Sun Fire V440 Server Administration Guide*

Complete this task:

- “How to Avoid Electrostatic Discharge” on page 44

# What to Do

**1. Insert the disk drive into its bay.**

Follow Step 1 through Step 6 of “How to Install a Disk Drive” on page 60.

**2. Log in as superuser or root user:**

```
% su
Password:
#
```

**3. Configure the new disk drive using this command:**

```
# cfgadm -x configure /dev/rdisk/c0t0d0
```

where *c0t0d0* is the name of the disk drive to be configured.

The blue OK-to-Remove LED goes out, and the green Activity LED flashes as the disk drive is added to the device tree.

**4. Close and lock the system doors.**

# What Next

Mount any file systems associated with the disk drive. Restart any applications accessing the disk drive.



## Servicing the Fans

---

This chapter contains the following sections:

- “How to Remove the PCI Fan Tray” on page 67
- “How to Install the PCI Fan Tray” on page 70
- “How to Remove the CPU Fan Tray” on page 73
- “How to Install the CPU Fan Tray” on page 75

---

### How to Remove the PCI Fan Tray

---



**Caution** – Do not attempt to operate the system without the PCI fan tray (fan tray 0) installed. Doing so could overheat and seriously damage the system.

---

### Before You Begin

If the PCI fan tray (fan tray 0) fails, the system Service Required LED will light.

Complete these tasks:

- “How to Power Off the System” on page 23
- “How to Slide the System Out of the Cabinet” on page 29
- “How to Avoid Electrostatic Discharge” on page 44
- “How to Remove the Top Cover” on page 34

## What to Do

1. **Remove any long PCI cards installed in the system.**  
See “How to Remove a PCI Card” on page 93.
2. **Loosen the two Phillips No. 2 captive screws securing the crossbar to the chassis.**
3. **Remove the crossbar from the chassis and set it aside.**

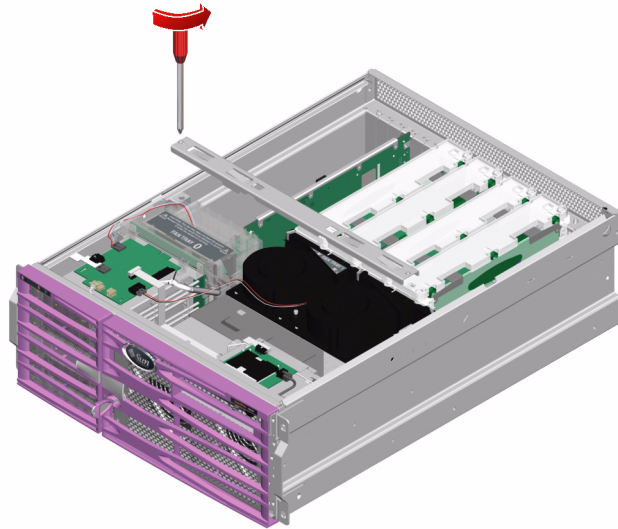



4. Disconnect the PCI fan tray cable at P7 on the connector board.

5. Pull the PCI fan tray up and out of the system.

Make sure to guide the side tab on the fan tray through the notch in the side of the chassis.

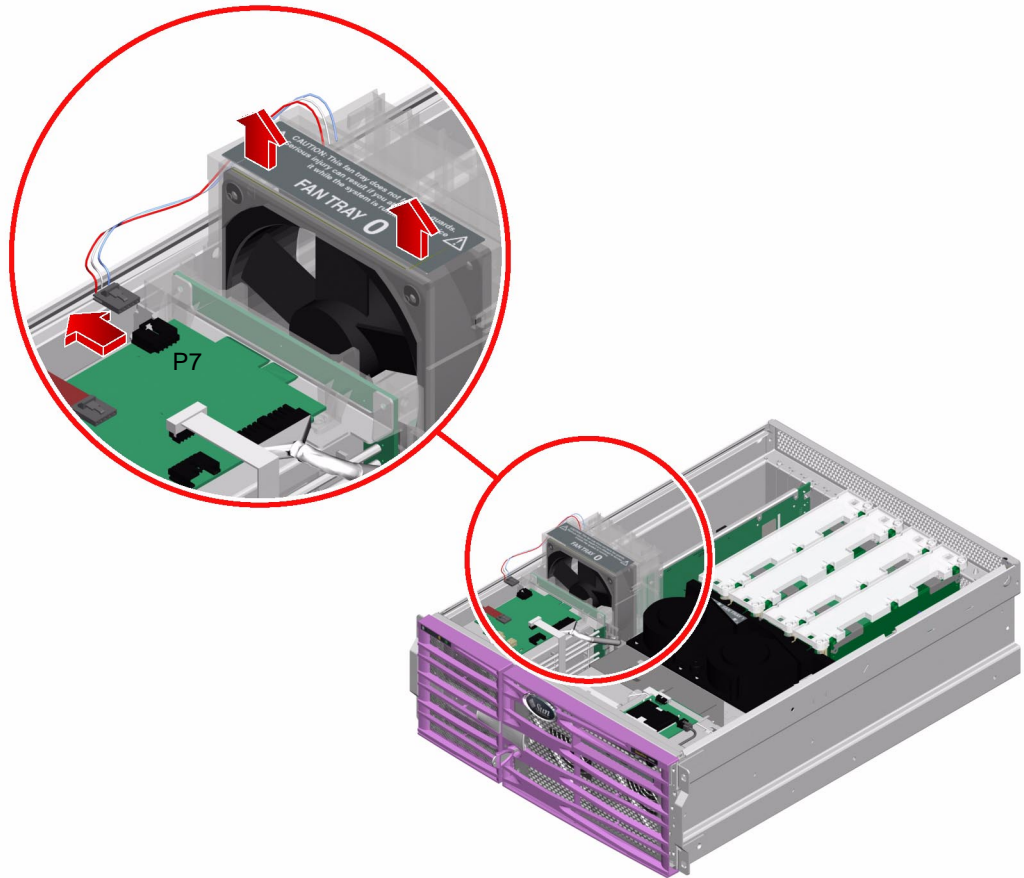

## What Next

Complete this task:

- “How to Install the PCI Fan Tray” on page 70

---

# How to Install the PCI Fan Tray



---

**Caution** – Do not power on the system without a functioning PCI fan tray (fan tray 0) installed. Doing so could overheat and seriously damage the system.

---

## Before You Begin

Complete this task:

- “How to Remove the PCI Fan Tray” on page 67

## What to Do

1. **Align the tabs on the PCI fan tray with their corresponding slots in the chassis.**  
The side tab fits into a slot in the chassis side. The two bottom tabs correspond to two slots in the bottom of the chassis.

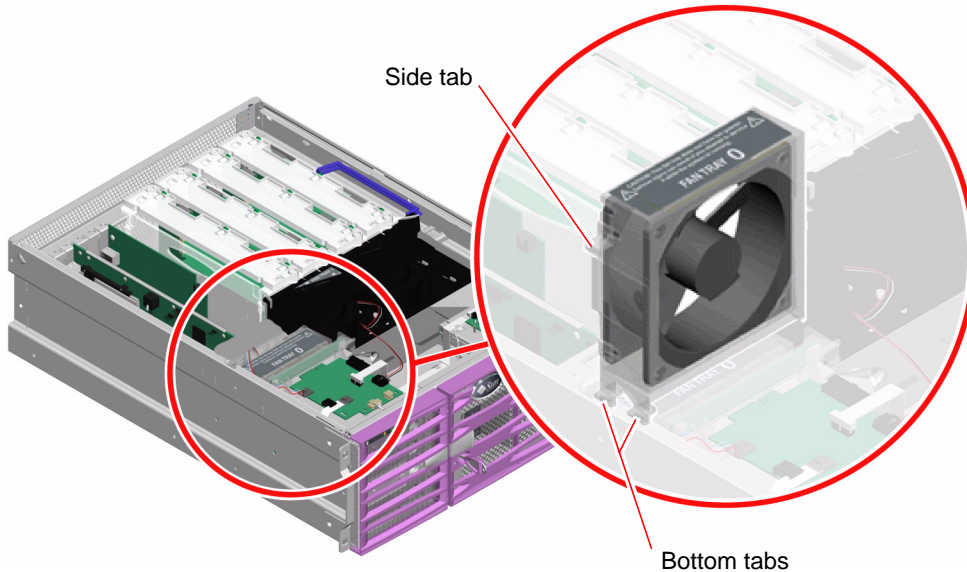

2. Insert the PCI fan tray into the system until it is firmly seated.

---

**Note** – Make sure that you align the card guides on the PCI fan tray with any long PCI cards in the system.

---

3. Connect the PCI fan tray cable at P7 on the connector board.

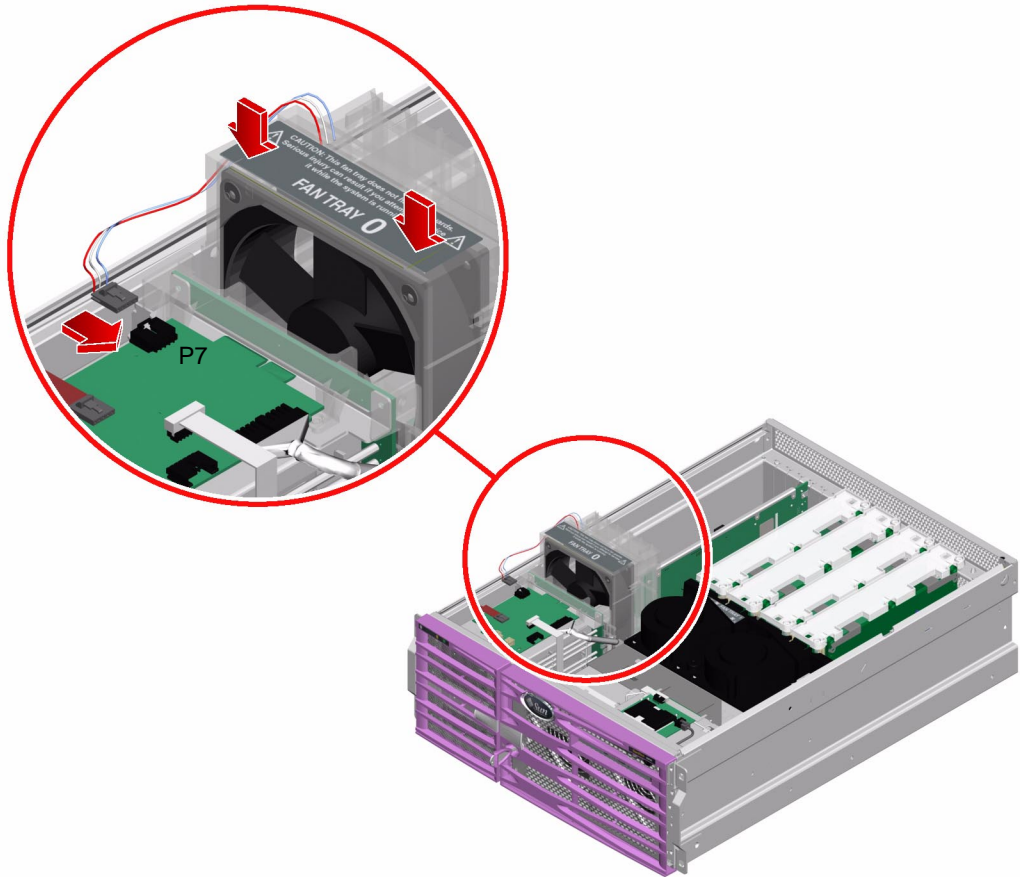

**4. Mount the crossbar onto the chassis.**

Make sure that the tab on the crossbar inserts into the slot on top of the PCI fan tray.

**5. Tighten the two Phillips No. 2 captive screws that secure the crossbar to the chassis.**

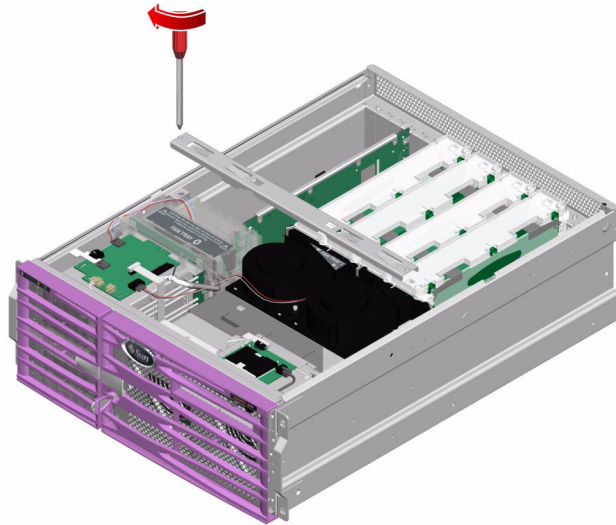

**6. Install any long PCI cards you removed.**

See “How to Install a PCI Card” on page 95.

## What Next

To reassemble the system, complete these tasks:

- “How to Install the Top Cover” on page 35
- “How to Slide the System Into the Cabinet” on page 32
- “How to Power On the System” on page 19

---

# How to Remove the CPU Fan Tray



---

**Caution** – Do not attempt to operate the system without the CPU fan tray (fan tray 1) installed. Doing so could overheat and seriously damage the system.

---

## Before You Begin

If the CPU fan tray (fan tray 1) fails, the system Service Required LED will light.

Complete these tasks:

- “How to Power Off the System” on page 23
- “How to Slide the System Out of the Cabinet” on page 29
- “How to Avoid Electrostatic Discharge” on page 44
- “How to Remove the Top Cover” on page 34

## What to Do

1. Loosen the two Phillips No. 2 captive screws securing the crossbar to the chassis.
2. Remove the crossbar from the chassis and set it aside.

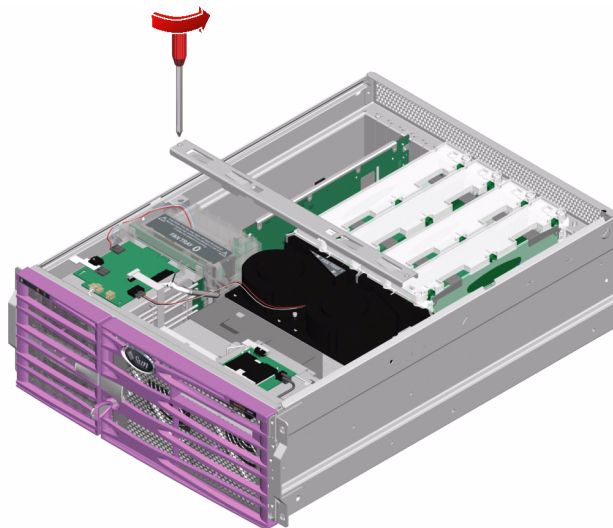

3. Loosen the Phillips No. 2 captive screw securing the CPU fan tray to the chassis.
4. Disconnect the CPU fan tray cable at P8 on the connector board.

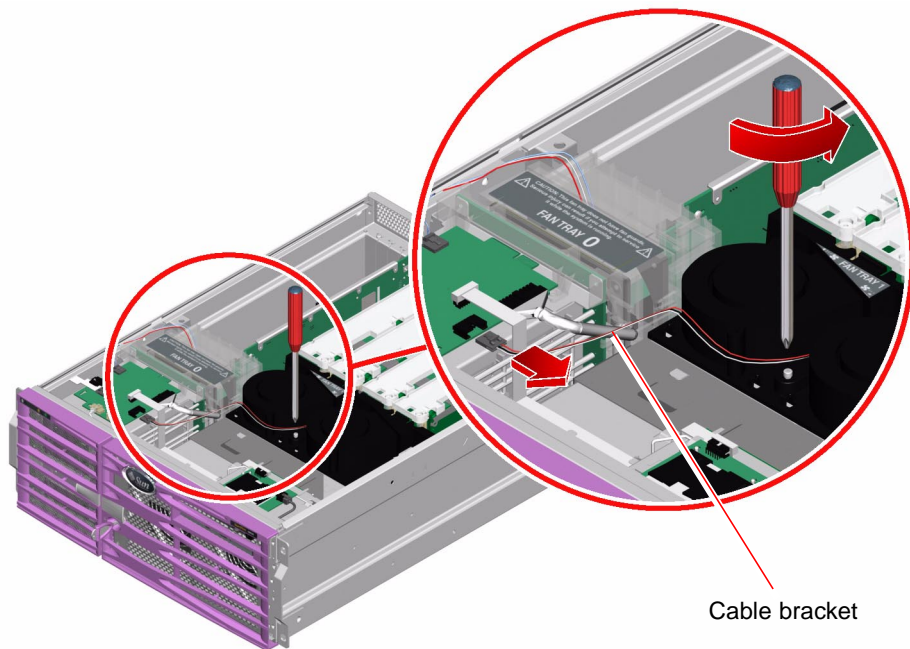

5. Remove the cable assembly from the cable bracket on the side of the SCSI backplane.
6. Slide the CPU fan tray toward the front of the system, releasing it from the hooks.
7. Pull the CPU fan tray up and out of the system at an angle, lifting the side near the PCI fan tray first.

## What Next

Complete this task:

- “How to Install the CPU Fan Tray” on page 75

---

# How to Install the CPU Fan Tray



---

**Caution** – Do not power on the system without a functioning CPU fan tray (fan tray 1) installed. Doing so could overheat and seriously damage the system.

---

## Before You Begin

Complete this task:

- “How to Remove the CPU Fan Tray” on page 73

## What to Do

- 1. Insert the CPU fan tray over the hooks on the chassis.**  
Insert the CPU fan tray at an angle, lowering the side near the PCI fan tray last.
- 2. Slide the CPU fan tray toward the back of the system until the hooks lock into place.**

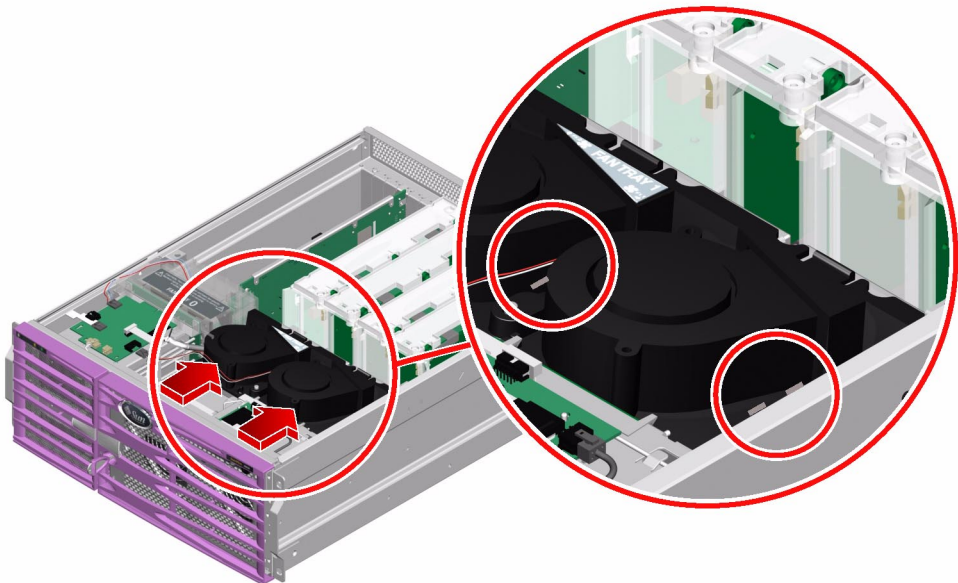

3. **Tighten the Phillips No. 2 captive screw that secures the CPU fan tray to the chassis.**

If the screw does not line up with the hole, the CPU fan tray is not seated properly.

4. **Connect the CPU fan tray cable at P8 on the connector board.**

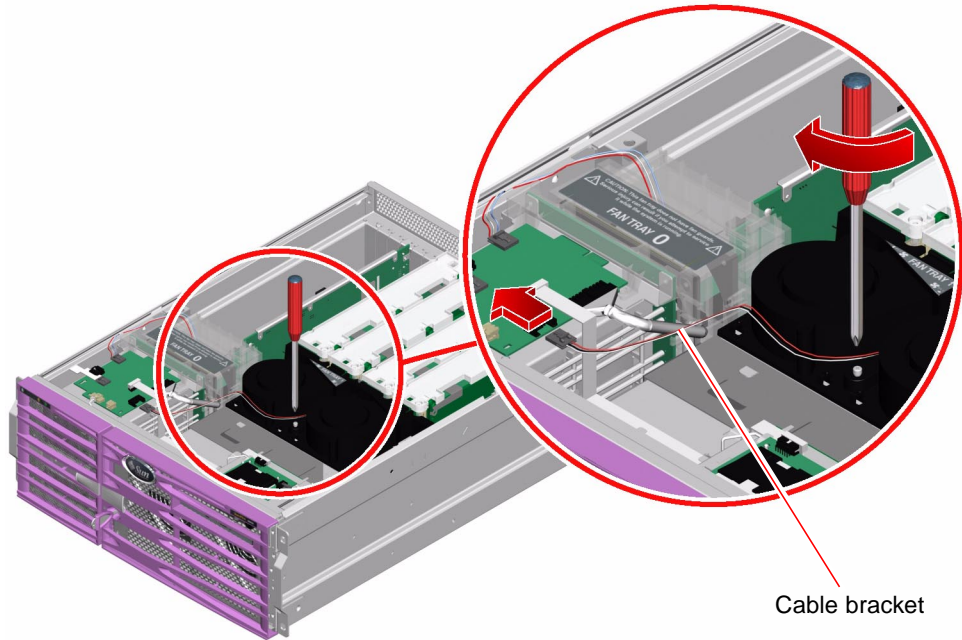

5. **Tuck the cable into the cable bracket on the side of the SCSI backplane.**



**6. Mount the crossbar onto the chassis.**

Make sure that the tab on the crossbar inserts into the slot on top of the PCI fan tray.

**7. Tighten the two Phillips No. 2 captive screws that secure the crossbar to the chassis.**

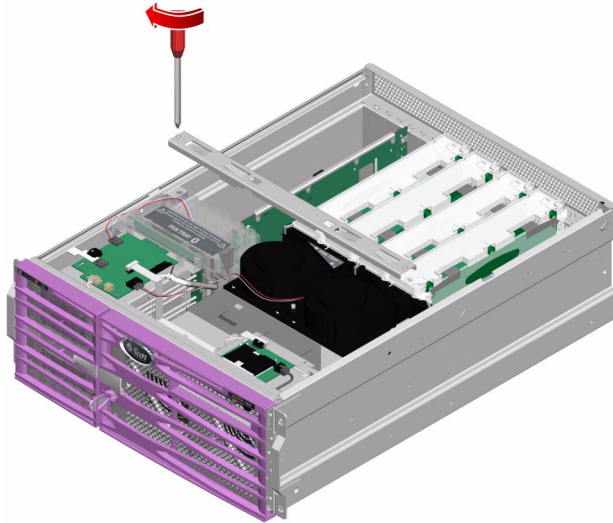

## What Next

To reassemble the system, complete these tasks:

- “How to Install the Top Cover” on page 35
- “How to Slide the System Into the Cabinet” on page 32
- “How to Power On the System” on page 19



## Servicing the Motherboard Components

---

This chapter contains the following sections:

- “How to Remove a CPU/Memory Module” on page 80
- “How to Install a CPU/Memory Module” on page 83
- “About the Memory Modules” on page 86
- “How to Remove a Memory Module” on page 88
- “How to Install a Memory Module” on page 90
- “How to Remove a PCI Card” on page 93
- “How to Install a PCI Card” on page 95
- “How to Remove the ALOM Card” on page 97
- “How to Install the ALOM Card” on page 99
- “How to Remove the Motherboard” on page 101
- “How to Install the Motherboard” on page 107

---

# How to Remove a CPU/Memory Module

## Before You Begin

If a CPU/memory module fails, POST diagnostics will alert ALOM to light the system status Service Required LED.

Complete these tasks:

- “How to Power Off the System” on page 23
- “How to Slide the System Out of the Cabinet” on page 29
- “How to Avoid Electrostatic Discharge” on page 44
- “How to Remove the Top Cover” on page 34

## What to Do

### 1. Identify the CPU/memory module to be removed.

See the *Sun Fire V440 Server Diagnostics and Troubleshooting Guide* for information about isolating failed parts.

2. Loosen the two Phillips No. 2 captive screws securing the CPU/memory module to the CPU cage.

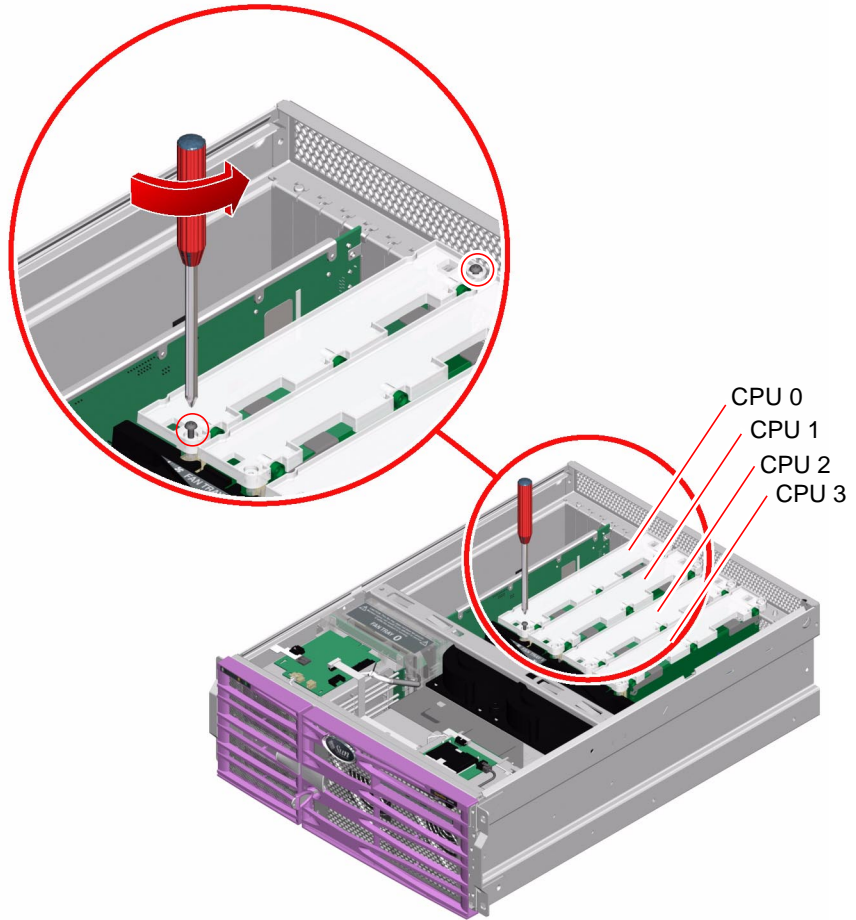

3. Rotate the CPU/memory module ejector levers upward so that the CPU/memory module connectors disengage from the CPU cage.
4. Pull the CPU/memory module from the chassis by the levers and place it on an antistatic mat.

Support the CPU/memory module from underneath as you transfer it to the antistatic mat.



---

**Caution** – The CPU/memory module can be hot. Handle the CPU/memory module carefully to avoid injury.

---

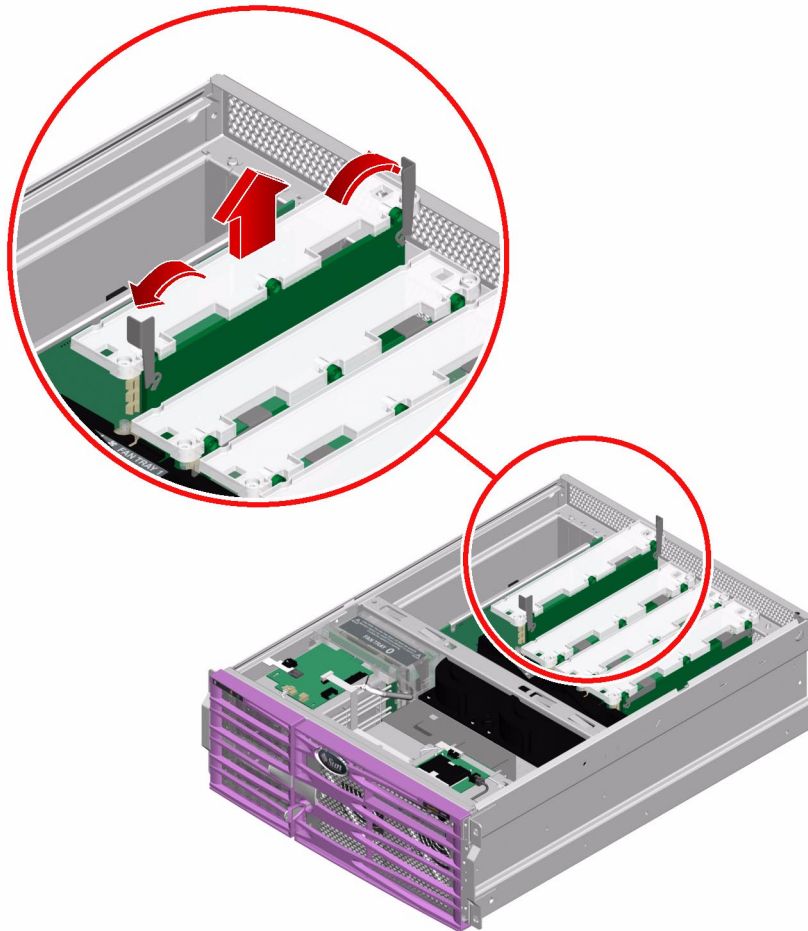

## What Next

To replace the CPU/memory module, complete this task:

- “How to Install a CPU/Memory Module” on page 83

---

# How to Install a CPU/Memory Module

## Before You Begin

Complete these tasks:

- “How to Avoid Electrostatic Discharge” on page 44
- “How to Remove a CPU/Memory Module” on page 80

## What to Do

- 1. Identify the CPU/memory module slot into which you want to install the CPU/memory module.**

The CPU/memory module slots are marked on the bottom of the CPU cage.

- 2. Inspect the CPU/memory module connector and the motherboard connector for foreign objects.**
- 3. Make sure that the ejector levers on the CPU/memory module are rotated up to a 90-degree angle.**

**4. Slide the CPU/memory module into the guides in the CPU cage.**

Slide the CPU/memory module into the chassis until the connectors on the module begin to engage the socket on the motherboard.

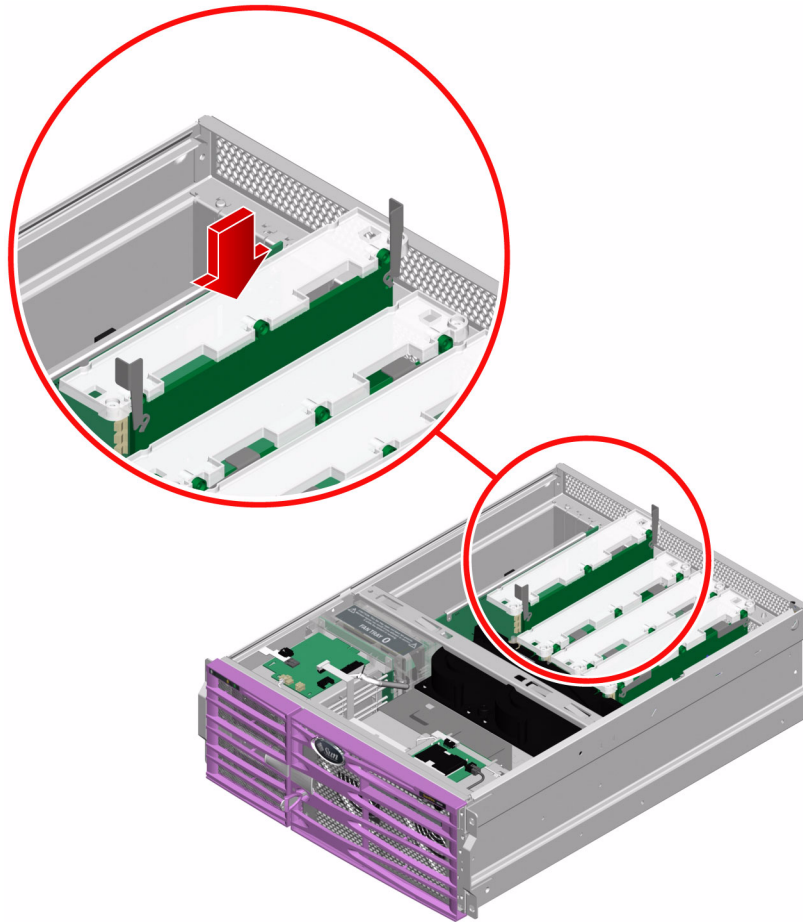

**5. Push down on both ejector levers, simultaneously, until the levers are completely pressed into their slots.**

---

**Note** – Do not press down directly on the CPU/memory module. Let the levers press the CPU/memory module into its socket.

---



6. Tighten the two Phillips No. 2 captive screws that secure the CPU/memory module to the CPU cage.

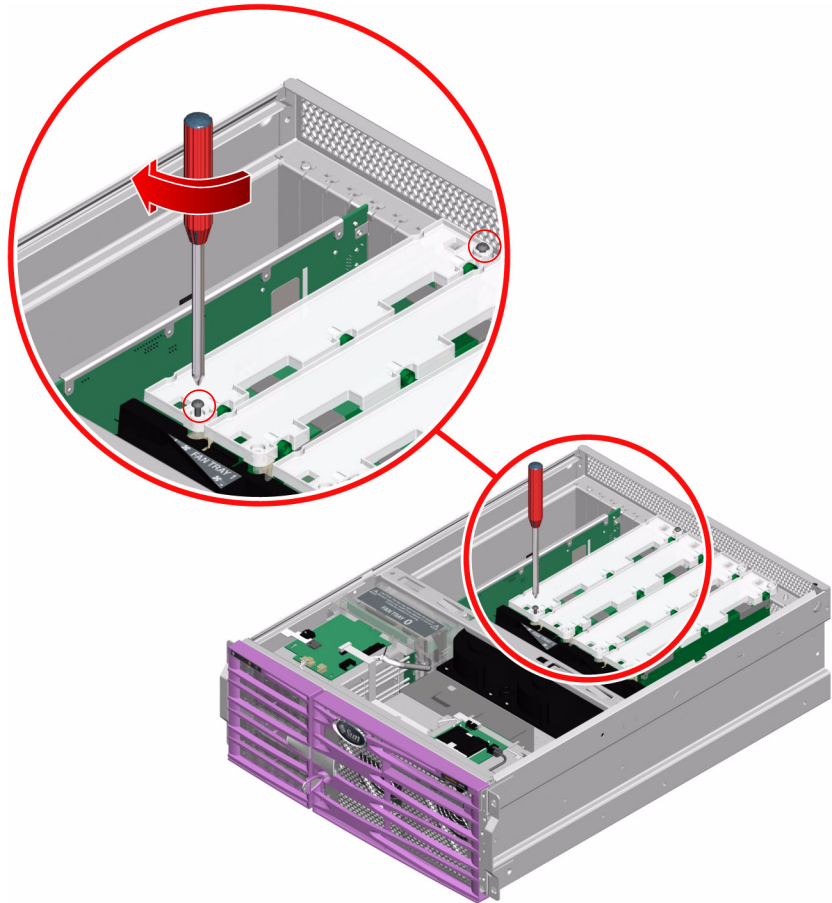

## What Next

To reassemble the system, complete these tasks:

- “How to Install the Top Cover” on page 35
- “How to Slide the System Into the Cabinet” on page 32
- “How to Power On the System” on page 19

---

# About the Memory Modules

The Sun Fire V440 server uses 2.5-volt, high-capacity double data-rate dual inline memory modules (DDR DIMMs) with error-correcting code (ECC). The system supports DIMMs with 512-Mbyte and 1-Gbyte capacities.

Within each CPU/memory module, the four DIMM slots are organized into groups of two. The system reads from, or writes to, both DIMMs in a group simultaneously. DIMMs, therefore, must be added in pairs. The figure below shows the DIMM slots and DIMM groups on a Sun Fire V440 server CPU/memory module. Adjacent slots belong to the same DIMM group. The two groups are designated 0 and 1.

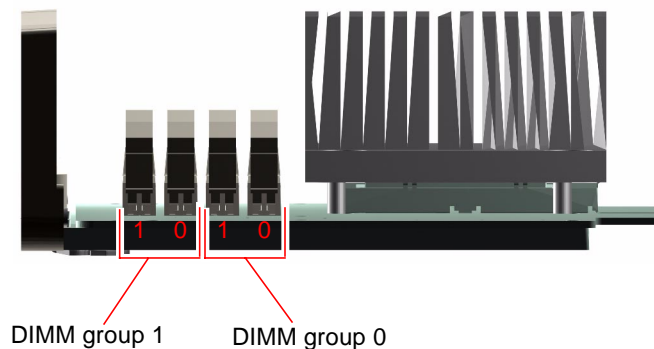

You must physically remove a CPU/memory module from the system before you can install or remove DIMMs. The DIMMs must be added in pairs within the same DIMM group, and each pair used must have two identical DIMMs installed—that is, both DIMMs in each group must be from the same manufacturing vendor and must have the same capacity (for example, two 512-Mbyte DIMMs or two 1-Gbyte DIMMs).

---

**Note** – Each CPU/memory module must be populated with a minimum of two DIMMs, installed in either group 0 or group 1.

---



---

**Caution** – DIMMs are made of electronic components that are extremely sensitive to static electricity. Static electricity from your clothes or work environment can destroy the DIMM. Do not remove a DIMM from its antistatic packaging until you are ready to install it on the CPU/memory module. Handle the DIMM only by its edges. Do not touch the components or any metal part. Always wear an antistatic grounding strap when you handle the DIMM. For more information, see “How to Avoid Electrostatic Discharge” on page 44.

---

## Memory Interleaving

You can maximize the system’s memory bandwidth by taking advantage of its memory interleaving capabilities. The Sun Fire V440 server supports two-way interleaving. In most cases, higher interleaving results in improved system performance. However, actual performance results can vary depending on the system application. Two-way interleaving occurs automatically in any DIMM bank where the DIMM capacities in DIMM group 1 do not match the capacities used in aDIMM group 2. For optimum performance, install identical DIMMs in all four slots in a CPU/memory module.

## Configuration Rules

- DIMMs must be added in pairs within the same group of DIMM slots; adjacent slots belong to the same DIMM group.
- Each group used must have two identical DIMMs installed—that is, both DIMMs must be from the same manufacturing vendor and must have the same capacity (for example, two 512-Mbyte DIMMs or two 1-Gbyte DIMMs).
- For maximum memory performance and to take full advantage of the Sun Fire V440 server’s memory interleaving features, use identical DIMMs in all four slots of a CPU/memory module.

---

**Note** – If DIMMs of different densities and speeds are installed as a pair, both DIMMs will operate at the lower density and slower speed.

---

---

# How to Remove a Memory Module

## Before You Begin

If a memory module (DIMM) fails, POST diagnostics will alert ALOM to light the system status Service Required LED.

Read the section:

- “About the Memory Modules” on page 86

Complete these tasks:

- “How to Avoid Electrostatic Discharge” on page 44
- “How to Remove a CPU/Memory Module” on page 80

## What to Do



---

**Caution** – DIMMs are made of electronic components that are extremely sensitive to static electricity. Static electricity from your clothes or work environment can destroy the DIMM. Do not remove a DIMM from its antistatic packaging until you are ready to install it on the CPU/memory module. Handle the DIMM only by its edges. Do not touch the components or any metal part. Always wear an antistatic grounding strap when you handle the DIMM. For more information, see “How to Avoid Electrostatic Discharge” on page 44.

---



---

**Caution** – The CPU/memory module and the DIMMs can be hot. Handle the CPU/memory module and the DIMMs carefully to avoid injury.

---

### 1. Identify the memory module to be removed.

See the *Sun Fire V440 Server Diagnostics and Troubleshooting Guide* for information about isolating failed parts.

- 2. Push down on the ejector levers on each side of the memory module, simultaneously, until the memory module ejects from its socket.**  
Apply even pressure on both levers.

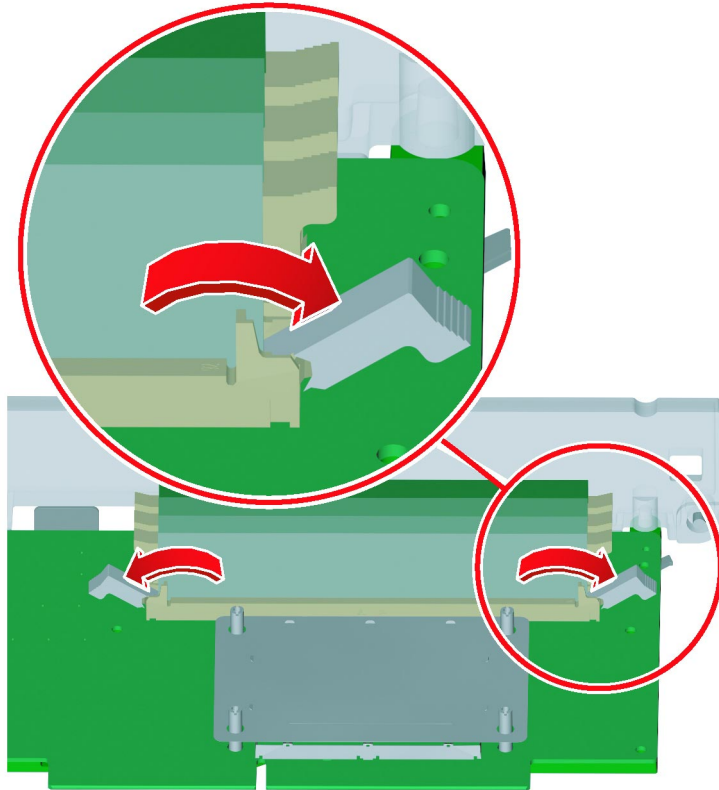

3. Grasp the top corners of the memory module and pull it up and out of its socket.

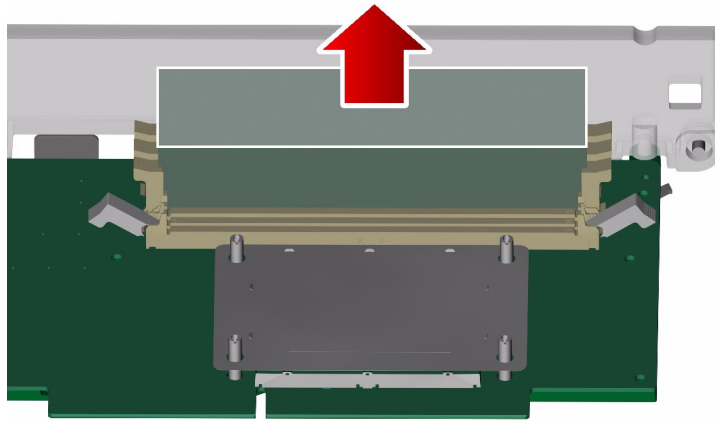

4. Place the memory module on an antistatic mat.
5. Repeat Step 1 through Step 4 for all the memory modules to be removed.

## What Next

To replace a memory module, complete this task:

- “How to Install a Memory Module” on page 90

---

# How to Install a Memory Module

## Before You Begin

Read the section:

- “About the Memory Modules” on page 86

Complete these tasks:

- “How to Avoid Electrostatic Discharge” on page 44
- “How to Remove a CPU/Memory Module” on page 80

## What to Do



---

**Caution** – DIMMs are made of electronic components that are extremely sensitive to static electricity. Static electricity from your clothes or work environment can destroy the DIMM. Do not remove a DIMM from its antistatic packaging until you are ready to install it on the CPU/memory module. Handle the DIMM only by its edges. Do not touch the components or any metal part. Always wear an antistatic grounding strap when you handle the DIMM. For more information, see “How to Avoid Electrostatic Discharge” on page 44.

---



---

**Caution** – The CPU/memory module and the DIMMs can be hot. Handle the CPU/memory module and the DIMMs carefully to avoid injury.

---

1. **Locate the slot into which you will install the memory module.**
2. **Rotate out the memory module ejector levers for that slot.**

- 3. Holding the bottom edge of the module parallel to its socket, carefully align the module so that each of its contacts is centered on a socket pin.**

Make sure that the memory module is correctly oriented. A notch along the bottom of the memory module corresponds to a tab on the socket.

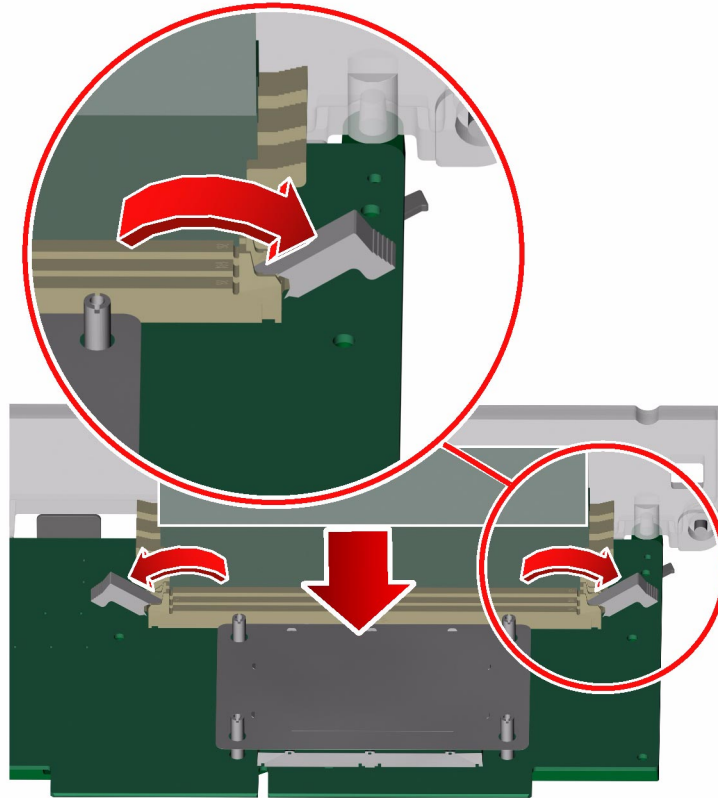

- 4. Push firmly and evenly on both ends of the memory module until its bottom edge is firmly seated in the socket.**

You will hear a click when the ejector levers lock into place.

- 5. Repeat Step 1 through Step 4 for all memory modules to be installed.**

## What Next

To reassemble the system, complete this task:

- “How to Install a CPU/Memory Module” on page 83



---

# How to Remove a PCI Card

## Before You Begin

Complete these tasks:

- “How to Power Off the System” on page 23
- “How to Slide the System Out of the Cabinet” on page 29
- “How to Avoid Electrostatic Discharge” on page 44
- “How to Remove the Top Cover” on page 34

## What to Do

- 1. Disconnect any external cables attached to the faceplate of the PCI card.**
- 2. Disconnect any internal cables connected to the PCI card internal connectors.**

3. Remove the Phillips No. 1 screw securing the card to the system back panel.

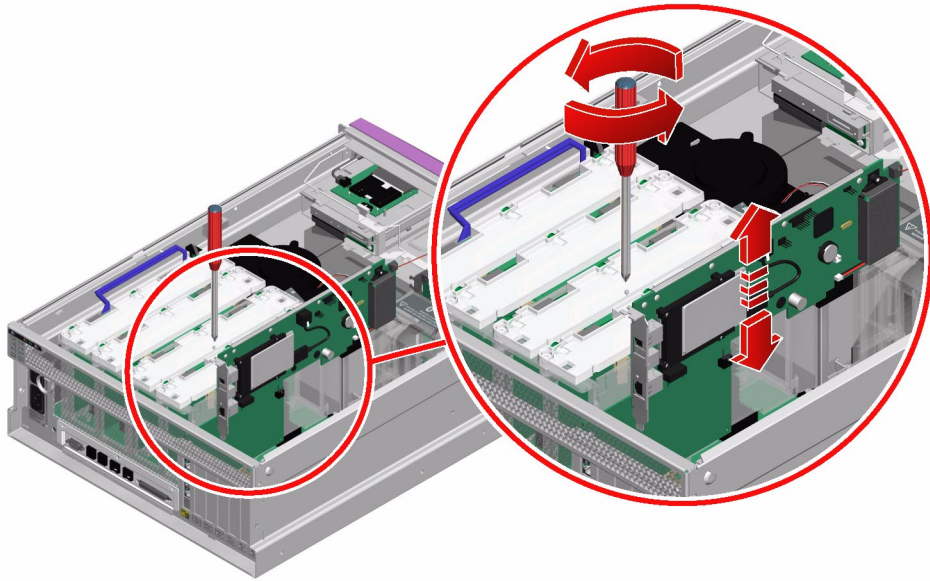

4. Pull the PCI card from its slot.

Hold the card by the faceplate and its opposite edge. Pull up while rocking the card from end to end until it is freed from its slot.



---

**Caution** – Do not apply excessive force to one end or one side of the card. Doing so could damage the card.

---

5. Place the PCI card on an antistatic mat.
6. If you are not replacing the PCI card, install a PCI filler panel.

The PCI filler panel prevents debris from entering the system and ensures proper cooling.

  - a. Slide the filler panel into the appropriate slot.
  - b. Replace the Phillips No. 1 screw that secures the filler panel to the system back panel.

## What Next

To install a PCI card, complete this task:

- “How to Install a PCI Card” on page 95

To reassemble the system, complete these tasks:

- “How to Install the Top Cover” on page 35
- “How to Slide the System Into the Cabinet” on page 32
- “How to Power On the System” on page 19

---

# How to Install a PCI Card

## Before You Begin

Complete these tasks:

- “How to Power Off the System” on page 23
- “How to Slide the System Out of the Cabinet” on page 29
- “How to Avoid Electrostatic Discharge” on page 44
- “How to Remove the Top Cover” on page 34

Read the documentation supplied with the PCI card for information about jumper settings, PCI slot requirements, and cable connections.

## What to Do

### 1. Locate an unused PCI slot.

---

**Note** – PCI slots 2, 4, and 5 can handle 33-MHz or 66-MHz cards. PCI slots 0, 1, and 3 are reserved for 33-MHz cards.

---

---

**Note** – Installing a 33-MHz PCI card into a 66-MHz slot (slots 2, 4, or 5) causes each card or device on that bus to operate at 33-MHz. For more information about PCI cards and buses, see the *Sun Fire V440 Server Administration Guide*.

---

2. If you are installing a PCI card into an unused slot, remove the corresponding filler panel from the system back panel. Otherwise, go to Step 3.

a. Remove the Phillips No. 1 screw securing the PCI filler panel to the system back panel.

b. Lift out the filler panel and save it for future use.

3. Insert the PCI card into the appropriate slot on the motherboard.

Make sure that the faceplate of the PCI card is not bent. A bent faceplate could affect the installation of the card.

a. Insert the faceplate end of the card into the appropriate opening in the back panel.

If you are installing a PCI long card, guide the opposite end of the PCI card into the correct card guide on the PCI fan tray (fan tray 0).

b. Push the card into the corresponding connector on the motherboard.

Apply even pressure along each edge of the card.



---

**Caution** – Do not apply excessive force to one end or one side of the card. Doing so could damage the card or the motherboard connector.

---

4. Secure the PCI card faceplate to the system back panel with the Phillips No. 1 screw.

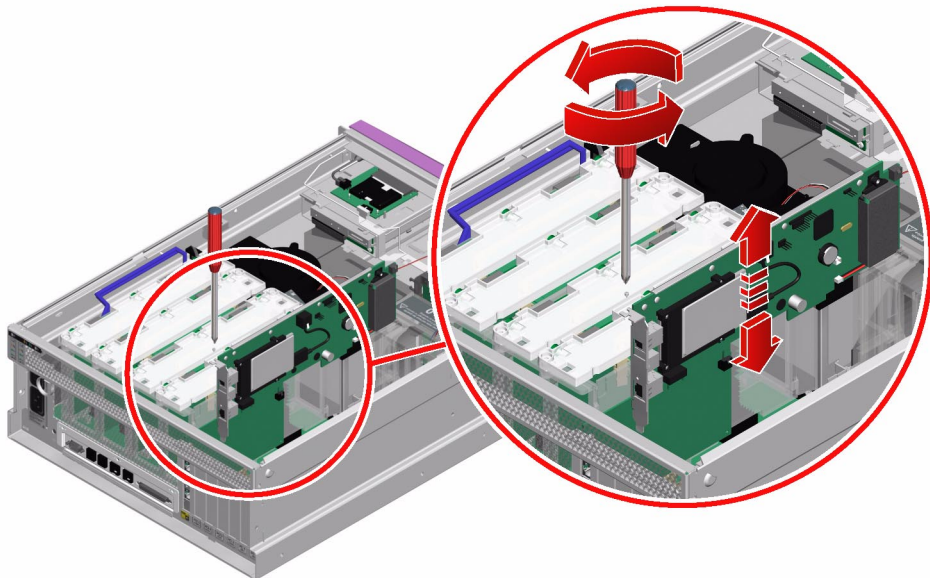

5. If necessary, connect any internal cables to the PCI card internal connectors.
6. If necessary, connect any external cables to the PCI card.

## What Next

To reassemble the system, complete these tasks:

- “How to Install the Top Cover” on page 35
- “How to Install the System Into the Cabinet” on page 39

When you are ready to restart the system, be sure to run OpenBoot Diagnostics tests to verify that the system functions correctly with the new parts you have just installed. For additional information, see:

- *Sun Fire V440 Server Administration Guide*

You must also perform a reconfiguration boot so that your system is able to recognize the new PCI card. For additional information, see:

- “How to Initiate a Reconfiguration Boot” on page 26

---

# How to Remove the ALOM Card

## Before You Begin

Complete these tasks:

- “How to Power Off the System” on page 23
- “How to Slide the System Out of the Cabinet” on page 29
- “How to Avoid Electrostatic Discharge” on page 44
- “How to Remove the Top Cover” on page 34

## What to Do



---

**Caution** – The system supplies power to the ALOM system controller card even when the system is powered off. To avoid personal injury or damage to the ALOM card, you must disconnect the AC power cords before servicing the ALOM card.

---

1. **Disconnect the AC power cords from the back of the system.**
2. **Locate the Advanced Lights Out Manager (ALOM) system controller card.**
3. **Disconnect any external cables attached to the faceplate of the ALOM card.**  
Note and label cable connector locations.
4. **Remove the Phillips No. 1 screw securing the card to the system back panel.**



---

**Caution** – Make sure that the AC power cords are disconnected from the system before removing the ALOM card.

---

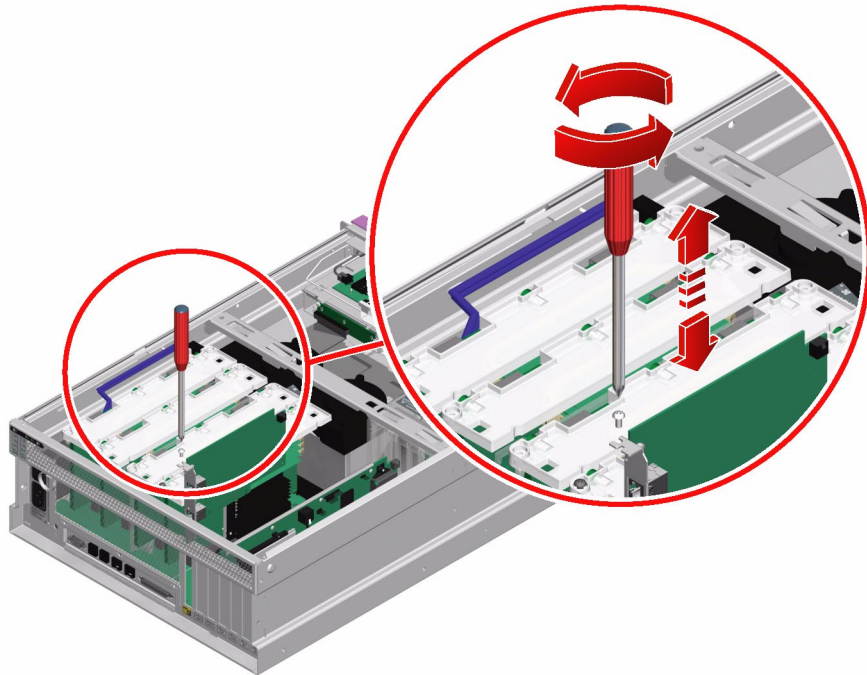

**5. Pull the ALOM card from its slot.**

Hold the card by the faceplate and its opposite edge. Pull up while rocking the card from end to end until it is freed from its slot.

**6. Place the ALOM card on an antistatic mat.**

## What Next

To replace the ALOM card, complete this task:

- “How to Install the ALOM Card” on page 99

---

# How to Install the ALOM Card

## Before You Begin

Complete this task:

- “How to Remove the ALOM Card” on page 97

## What to Do

**1. Locate the slot for the ALOM system controller card.**



---

**Caution** – Make sure that the AC power cords are disconnected from the system before installing the ALOM card.

---

---

**Note** – Make sure that you install the ALOM card into the ALOM slot. Though the ALOM card may physically fit into a PCI slot, it will not function if installed there.

---

2. **Insert the ALOM card into its slot on the motherboard.**
  - a. **Insert the faceplate end of the card into the appropriate opening in the system back panel.**
  - b. **Push the card into the connectors on the motherboard.**  
Apply even pressure along each edge of the card.
3. **Secure the ALOM card faceplate to the back panel with the Phillips No. 1 screw.**

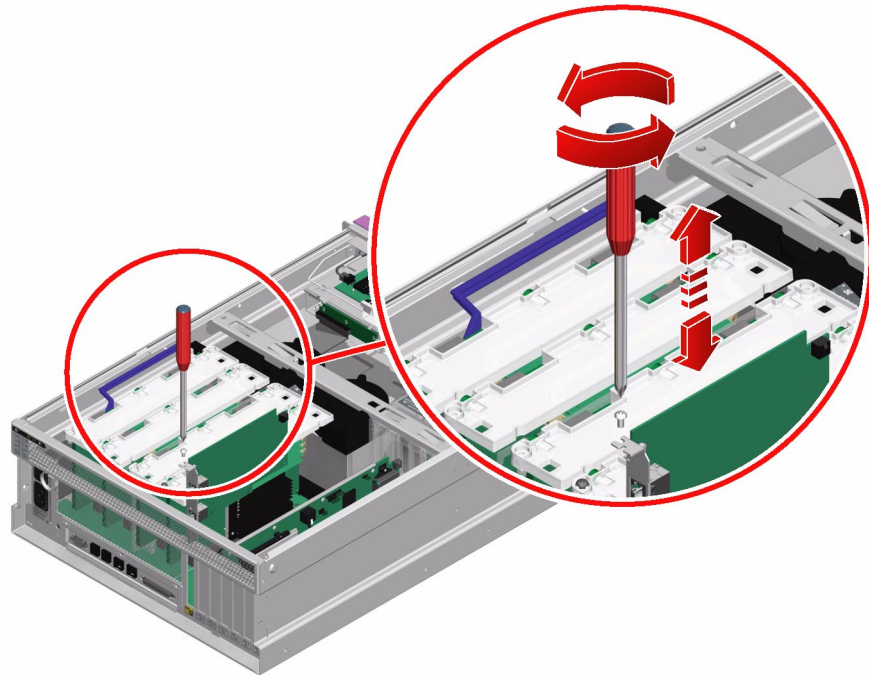

4. **Connect the cables to the faceplate of the ALOM card.**
5. **Connect the AC power cords to the back of the system.**

## What Next

To reassemble the system, complete these tasks:

- “How to Install the Top Cover” on page 35
- “How to Slide the System Into the Cabinet” on page 32
- “How to Power On the System” on page 19



---

# How to Remove the Motherboard

## Before You Begin

Complete these tasks:

- “How to Power Off the System” on page 23
- “How to Slide the System Out of the Cabinet” on page 29
- “How to Avoid Electrostatic Discharge” on page 44
- “How to Remove the Top Cover” on page 34
- “How to Remove the PCI Fan Tray” on page 67
- “How to Remove a CPU/Memory Module” on page 80
- “How to Remove a PCI Card” on page 93
- “How to Remove the ALOM Card” on page 97

## What to Do



---

**Caution** – The system supplies power to the motherboard even when the system is powered off. To avoid personal injury or damage to the motherboard, you must disconnect the AC power cords before servicing the motherboard.

---

1. **Disengage the power supplies from the motherboard connectors.**
  - a. **Loosen the Phillips No. 2 captive screw securing the power supply to the chassis.**

Turn the screw until it stops.
  - b. **Pull the power supply out of its bay just enough to disengage the power supply connectors from the motherboard connectors.**

Leave the power supply in its bay, but disconnected from the motherboard.
  - c. **Repeat Step a and Step b for the other power supply.**

2. Slide the CPU fan tray (fan tray 1) forward to free the CPU cage.
  - a. Loosen the Phillips No. 2 captive screw on the CPU fan tray.
  - b. Slide fan tray 1 forward, over the DVD-ROM cable, as far as the hooks allow.

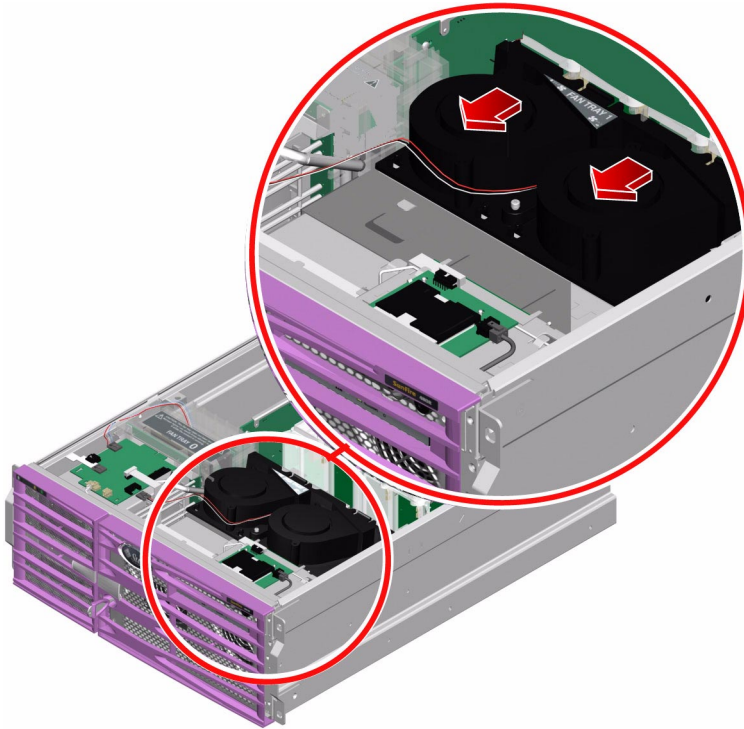

3. **Disconnect the AC inlet assembly from the back of the chassis.**
  - a. **Disconnect the P13 rear LED power cable end from its connector on the CPU side of the chassis.**

Lay the cable out of the way.
  - b. **Loosen the two Phillips No. 2 captive screws securing the AC inlet faceplate to the back of the chassis.**
  - c. **Press on the faceplate of the AC power inlet to dislodge the AC inlet from the chassis.**
  - d. **Disconnect the two reusable tie wraps securing the AC power cords to the CPU side of the chassis.**
  - e. **Lay the AC power inlet on the CPU cage.**

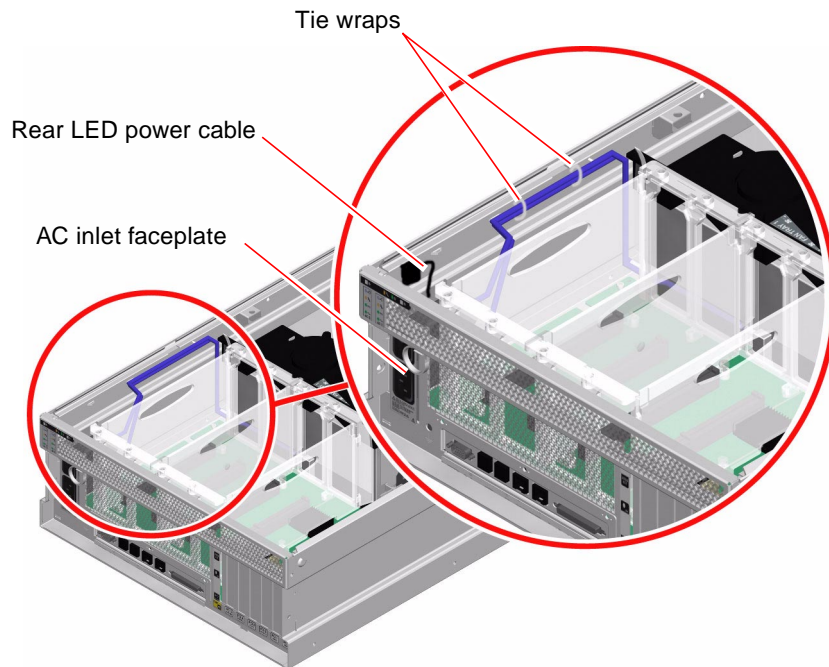

#### 4. Remove the I/O faceplate.

##### a. Disconnect any external cables attached to the motherboard.

Note and label connector locations.

##### b. Remove the three Phillips No. 2 screws securing the I/O faceplate to the chassis.

Pull the faceplate off the system and set it aside.

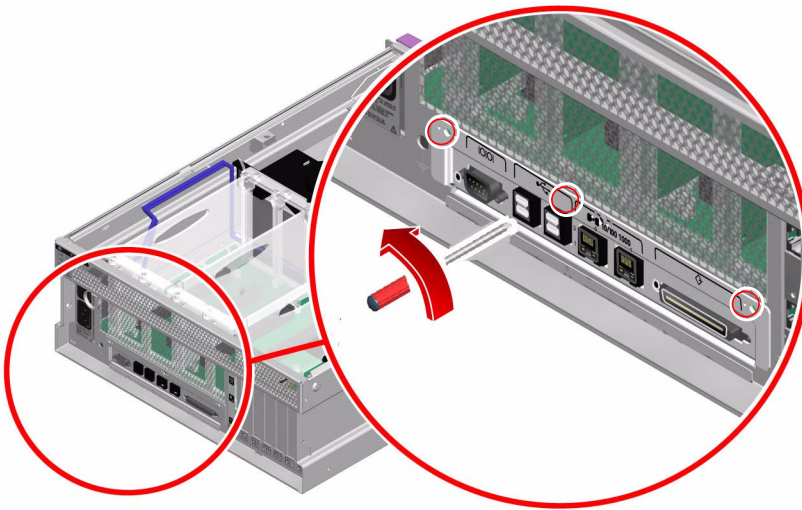

**5. Disconnect the P5 connector board power cable end at P5 on the motherboard.**

Press the locking tab on the cable end and pull it out of the connector.

**6. Disconnect the P1 DVD-ROM cable end at P1 on the motherboard.**

Lift up the connector ejector levers as far as they go to release the DVD-ROM cable end from the connector, then pull the DVD-ROM cable out of the connector.

**7. Disconnect the P3 SCSI data cable end at P3 on the motherboard.**

Hold the cable end by the edges and gently rock the cable from side to side as you pull it out of the connector.

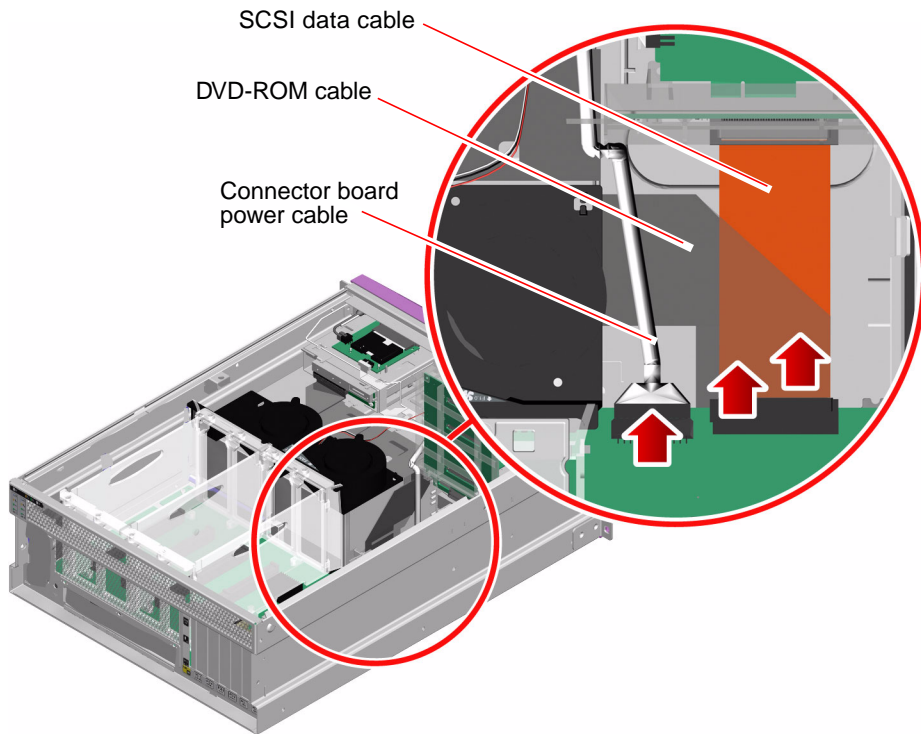



---

**Caution** – Do not remove the hex-head screws. Removing these screws could damage the motherboard.

---

- 8. Loosen the ten Phillips No. 2 captive screws securing the motherboard to the chassis.**

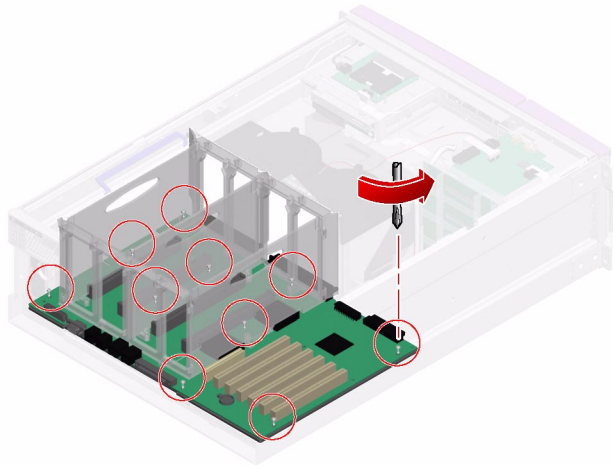

---

**Note** – Make sure that you do not unscrew the captive screws completely. Loosen the captive screws until you feel resistance.

---

### 9. Remove the motherboard from the chassis.

Remove the motherboard at an angle to clear the chassis sides.

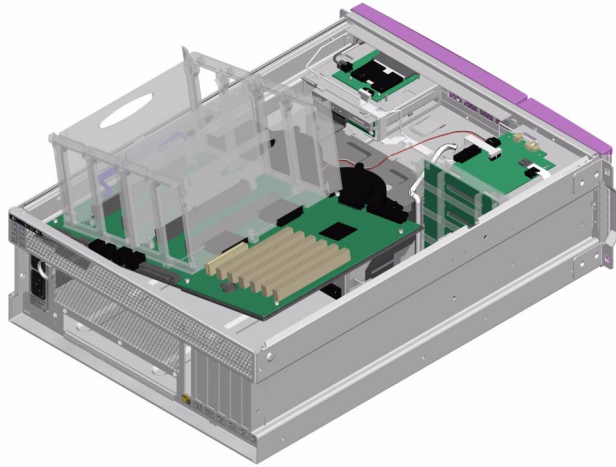

## What Next

Complete this task:

- “How to Install the Motherboard” on page 107

---

# How to Install the Motherboard

## Before You Begin

Complete this task:

- “How to Remove the Motherboard” on page 101

# What to Do

1. **Position the motherboard inside the chassis.**
  - a. **Align the motherboard with the chassis so the CPU cage sits directly behind the CPU fan tray (fan tray 1).**
  - b. **Make sure that the DVD-ROM cable and the SCSI cable are folded back out of the way.**
  - c. **Lower the motherboard into the chassis at an angle, inserting the CPU side of the board first.**
  - d. **Place the post on the bottom of the motherboard into the hole in the chassis to properly align the motherboard.**

The post is located on the corner of the motherboard near the SCSI backplane.

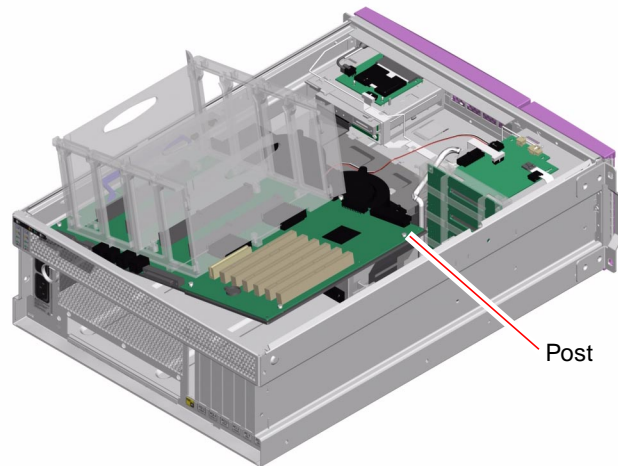



2. Tighten the ten Phillips No. 2 captive screws to secure the motherboard to the chassis.

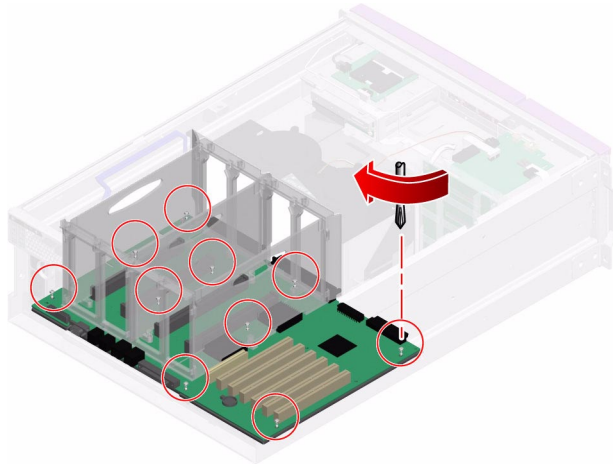

3. Connect the P3 SCSI data cable end at P3 on the motherboard.
4. Connect the P1 DVD-ROM cable end at P1 on the motherboard.
  - a. Make sure that the ejector levers are rotated up before inserting the cable.
  - b. Push the cable end into its connector until the ejector levers lie flat.

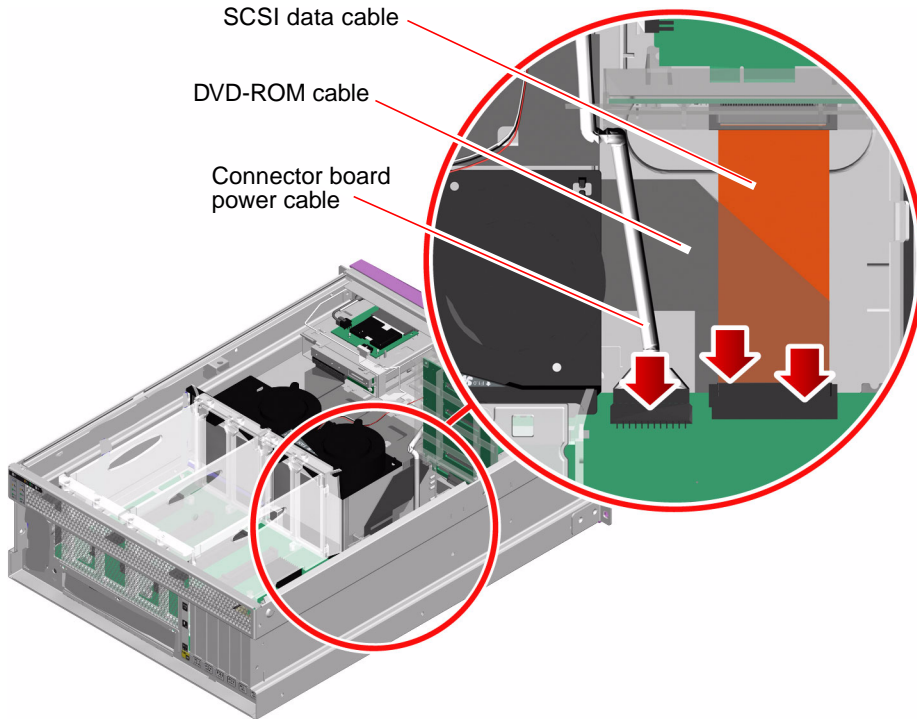

5. Connect the P5 connector board power cable end at P5 on the motherboard.

6. Install the AC inlet assembly.
  - a. Place the AC inlet assembly into the system, aligning the faceplate with the chassis back panel.
  - b. Secure the AC inlet assembly faceplate to the chassis with the two Phillips No. 2 captive screws.
  - c. Secure the AC cables to the side of the chassis using the two tie wraps provided.
  - d. Connect the P13 rear LED power cable end to its connector on the side of the chassis.
  - e. Secure the LED cable using the tie wrap provided.

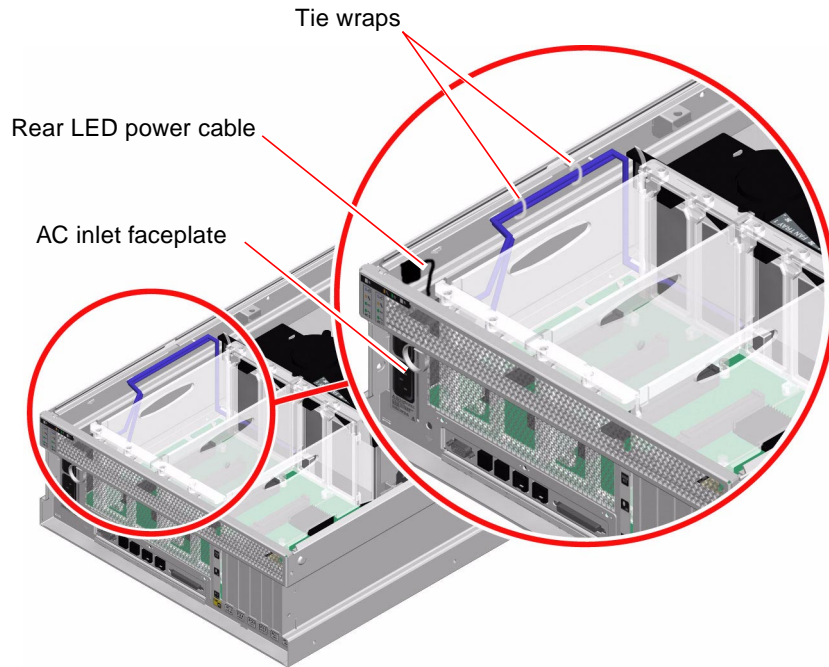

**7. Install the I/O faceplate.**

- a. Align the I/O faceplate on the back panel.**
- b. Secure the faceplate to the chassis using three Phillips No. 2 screws.**
- c. Connect any external cables, as needed.**

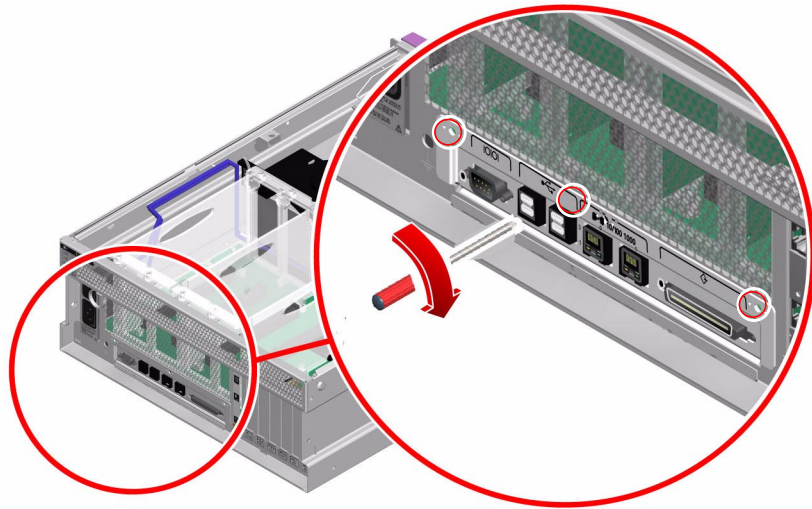

**8. Secure the CPU fan tray.**

- a. Slide the CPU fan tray toward the back of the system until the hooks lock into place.**
- b. Tighten the Phillips No. 2 captive screw that secures the CPU fan tray to the chassis.**

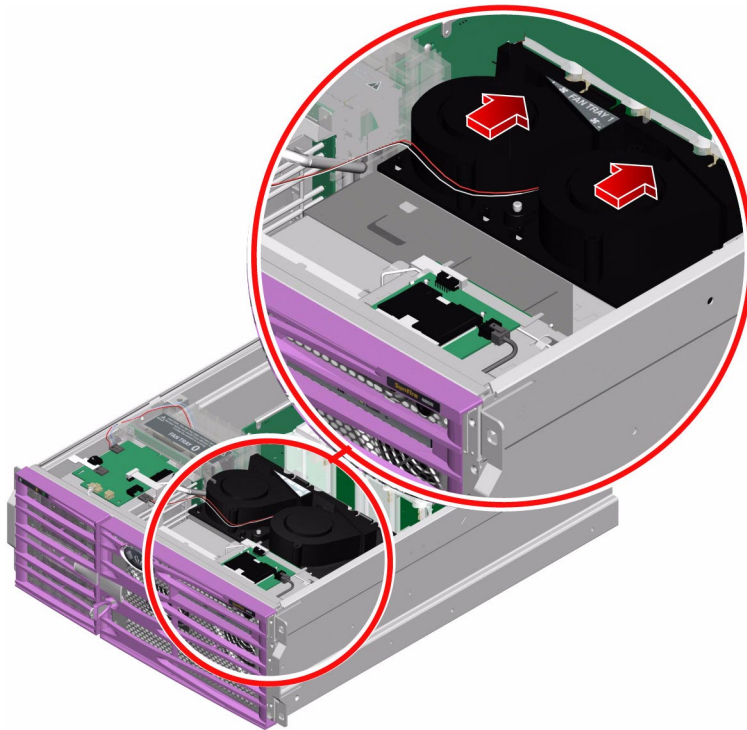

## **9. Connect the power supplies.**

- a. Push firmly on the front of the power supply to engage the power supply connectors with the motherboard connectors.**
- b. Tighten the Phillips No. 2 captive screw to secure the power supply to the chassis.**
- c. Repeat Step a and Step b for the other power supply.**

## **What Next**

To reassemble the system, complete these tasks:

- “How to Install the ALOM Card” on page 99
- “How to Install a PCI Card” on page 95
- “How to Install a CPU/Memory Module” on page 83
- “How to Install the PCI Fan Tray” on page 70
- “How to Install the Top Cover” on page 35
- “How to Slide the System Into the Cabinet” on page 32
- “How to Power On the System” on page 19

## Servicing Miscellaneous Components

---

This chapter contains the following sections:

- “How to Remove the DVD-ROM Drive” on page 116
- “How to Install the DVD-ROM Drive” on page 117
- “How to Remove the System Configuration Card” on page 119
- “How to Install the System Configuration Card” on page 120
- “How to Remove the System Configuration Card Reader” on page 122
- “How to Install the System Configuration Card Reader” on page 124
- “How to Remove the Connector Board” on page 126
- “How to Install the Connector Board” on page 128
- “How to Remove the SCSI Backplane” on page 130
- “How to Install the SCSI Backplane” on page 133

---

# How to Remove the DVD-ROM Drive

## Before You Begin

Complete these tasks:

- “How to Power Off the System” on page 23
- “How to Slide the System Out of the Cabinet” on page 29
- “How to Avoid Electrostatic Discharge” on page 44
- “How to Remove the Top Cover” on page 34

## What to Do

1. Press down on the two DVD-ROM drive locking tabs, releasing the DVD-ROM drive from its cage.

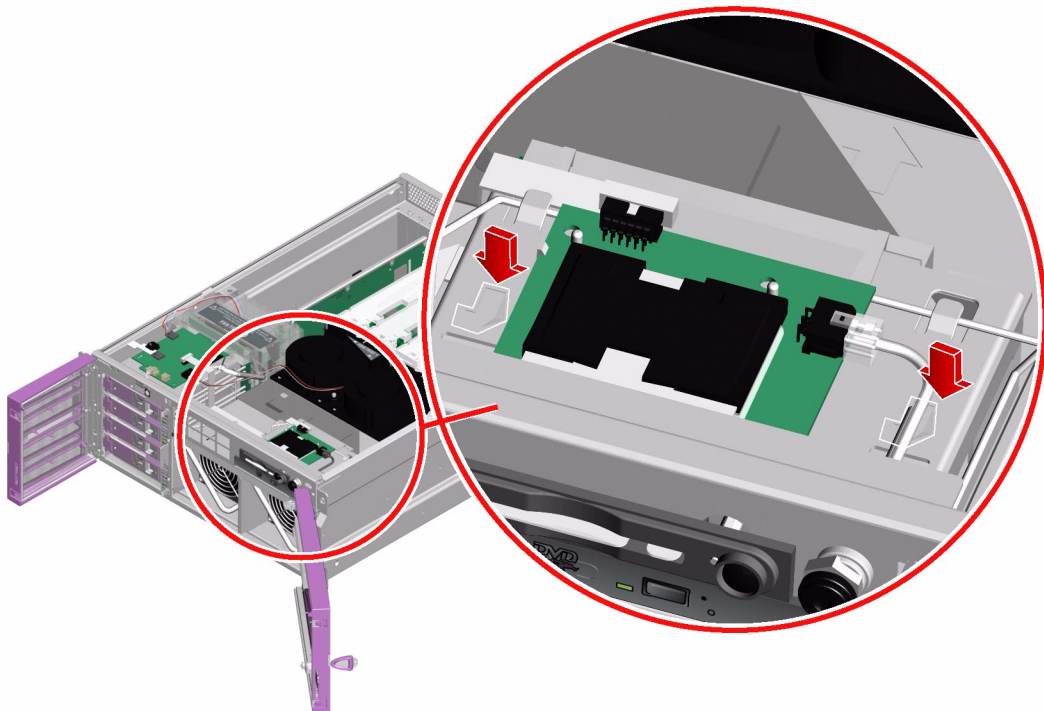



2. Pull out the DVD-ROM drive from the front of the system.

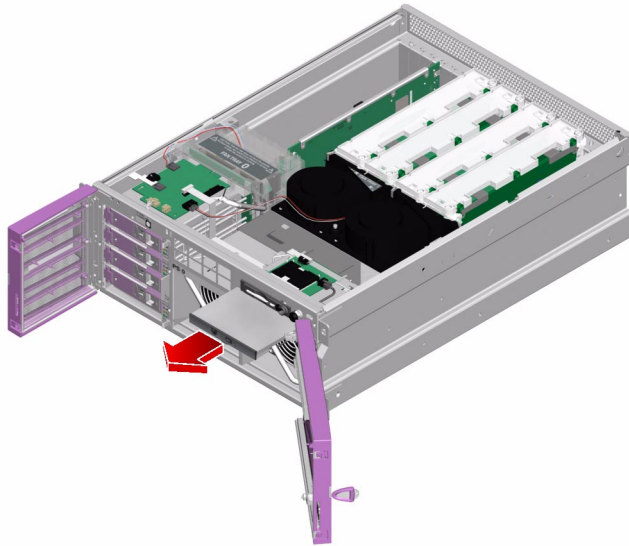

## What Next

Complete this task:

- “How to Install the DVD-ROM Drive” on page 117

---

# How to Install the DVD-ROM Drive

## Before You Begin

Complete this task:

- “How to Remove the DVD-ROM Drive” on page 116

## What to Do

- Slide the DVD-ROM drive into the system until the two DVD-ROM drive locking tabs click into place.

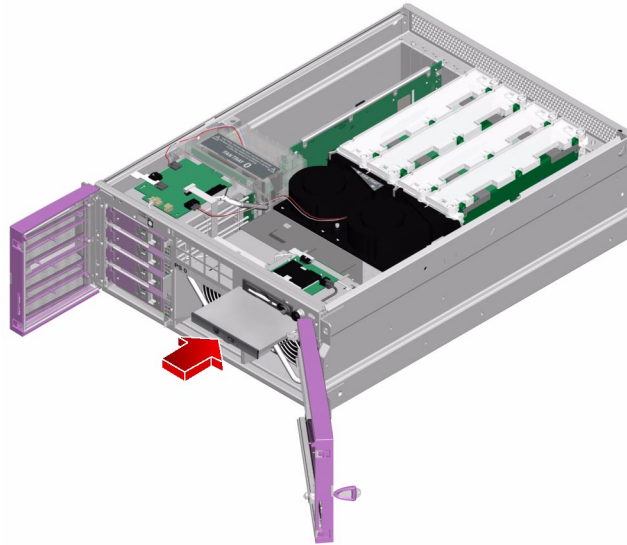

## What Next

Complete these tasks:

- “How to Install the Top Cover” on page 35
- “How to Slide the System Into the Cabinet” on page 32
- “How to Power On the System” on page 19

---

# How to Remove the System Configuration Card

## Before You Begin

This section explains how to remove a system configuration card (SCC). The SCC stores system configuration variables and MAC addresses. For more information, see “About the System Configuration Card” in the *Sun Fire V440 Server Administration Guide*.

You can replace a functioning SCC and install it into another system thereby preserving the system’s host ID information. Thus, migrating a SCC from one system to another can smooth transitions to new or upgraded systems, or quickly bring up a backup system if a primary system becomes unavailable, without disrupting the system’s identity on the network.

If you are replacing a defective SCC, you must contact a Sun service representative to obtain a new card with the existing server’s host ID and MAC address.



---

**Caution** – Do not handle the system configuration card unless you need to transfer it to another system. If you need to handle the card for this reason, avoid contact with the gold terminals on the underside of the card.

---

Complete these tasks:

- “How to Power Off the System” on page 23
- “How to Avoid Electrostatic Discharge” on page 44

## What to Do



---

**Caution** – Attempting to remove the system configuration card while the system is running causes an immediate system shutdown in 60 seconds.

---

1. **Locate the SCC reader, which is at the left of the Power button.**
2. **Pull the security post out of its position from in front of the SCC.**

3. Grasp the SCC with your fingers and pull it out of the system.

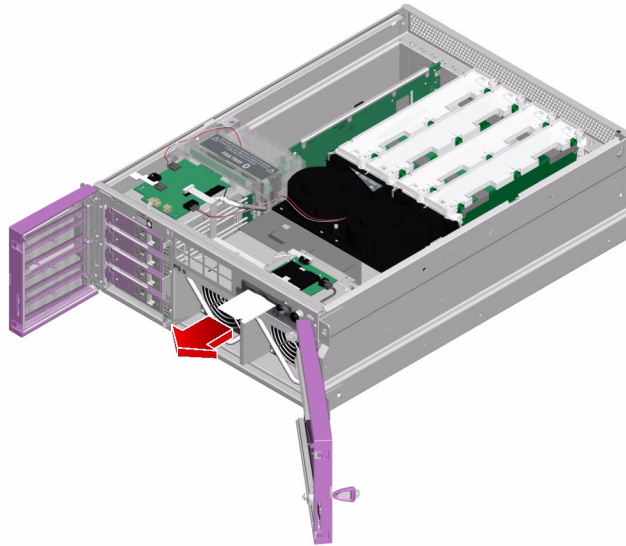

## What Next

Complete this task:

- “How to Install the System Configuration Card” on page 120

---

# How to Install the System Configuration Card

## Before You Begin

Complete this task:

- “How to Remove the System Configuration Card” on page 119

## What to Do

1. **Insert the SCC into the SCC reader, which is at the left of the Power button.**  
Orient the SCC so that the Sun logo is on the top of the card.

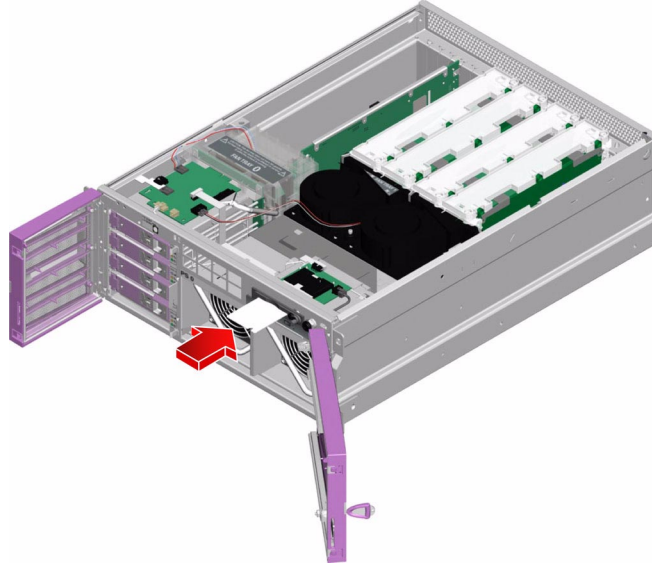

2. **Insert the security post into its position in front of the SCC.**

## What Next

Complete this task:

- “How to Power On the System” on page 19

---

# How to Remove the System Configuration Card Reader

## Before You Begin

Complete these tasks:

- “How to Power Off the System” on page 23
- “How to Slide the System Out of the Cabinet” on page 29
- “How to Avoid Electrostatic Discharge” on page 44
- “How to Remove the Top Cover” on page 34
- “How to Remove the System Configuration Card” on page 119

## What to Do



---

**Caution** – The system supplies power to the system configuration card reader even when the system is powered off. To avoid personal injury or damage to the system, you must disconnect the AC power cords before servicing the system configuration card reader.

---

1. **Disconnect the AC power cords from the back of the system.**

**2. Disconnect the cables from the system configuration card (SCC) reader.**

**a. Disconnect the connector board power cable at J18.**

Pull up on the cable end to release it from its connector.

**b. Disconnect the system control keyswitch cable at J2.**

Press the tab on the cable end to release it from its connector.

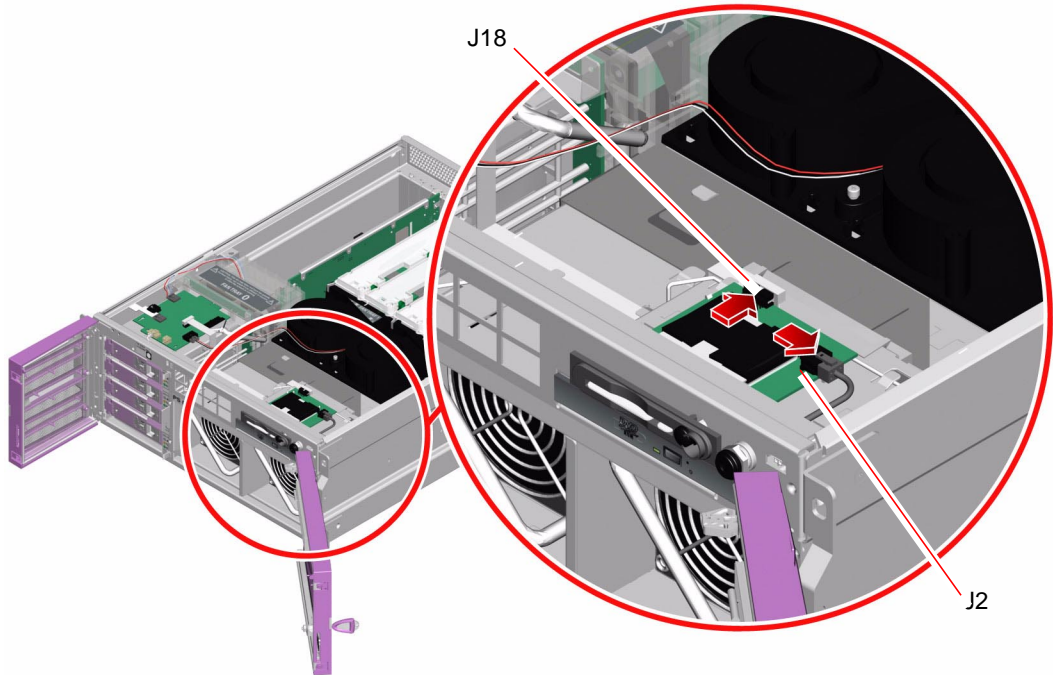

3. **Remove the SCC reader from the system.**
  - a. **Lift the back corners of the SCC reader until they snap free of the mounting posts.**
  - b. **Lift the front corners of the SCC reader until they snap free of the mounting posts.**
  - c. **Pull the SCC reader toward the back of the system, carefully guiding the Power button out of the chassis face, and set the SCC reader aside.**

## What Next

Complete this task:

- “How to Install the System Configuration Card Reader” on page 124

---

# How to Install the System Configuration Card Reader

## Before You Begin

Complete this task:

- “How to Power On the System” on page 19

## What to Do



---

**Caution** – The system supplies power to the system configuration card reader even when the system is powered off. To avoid personal injury or damage to the system, you must disconnect the AC power cords before servicing the system configuration card reader.

---

1. **Disconnect the AC power cords from the back of the system.**



2. **Insert the SCC reader into the system.**
  - a. **Insert the Power button through its hole in the chassis.**
  - b. **Align the holes in the SCC reader with the corresponding mounting posts on the chassis.**
3. **Snap the SCC reader into place.**

Press down on the front corners, then on the back corners of the SCC reader.
4. **Connect the cables to the SCC reader.**

Press the cable ends into the corresponding connectors.

  - a. **Connect the system control keyswitch cable at J2.**
  - b. **Connect the connector board power cable at J18.**

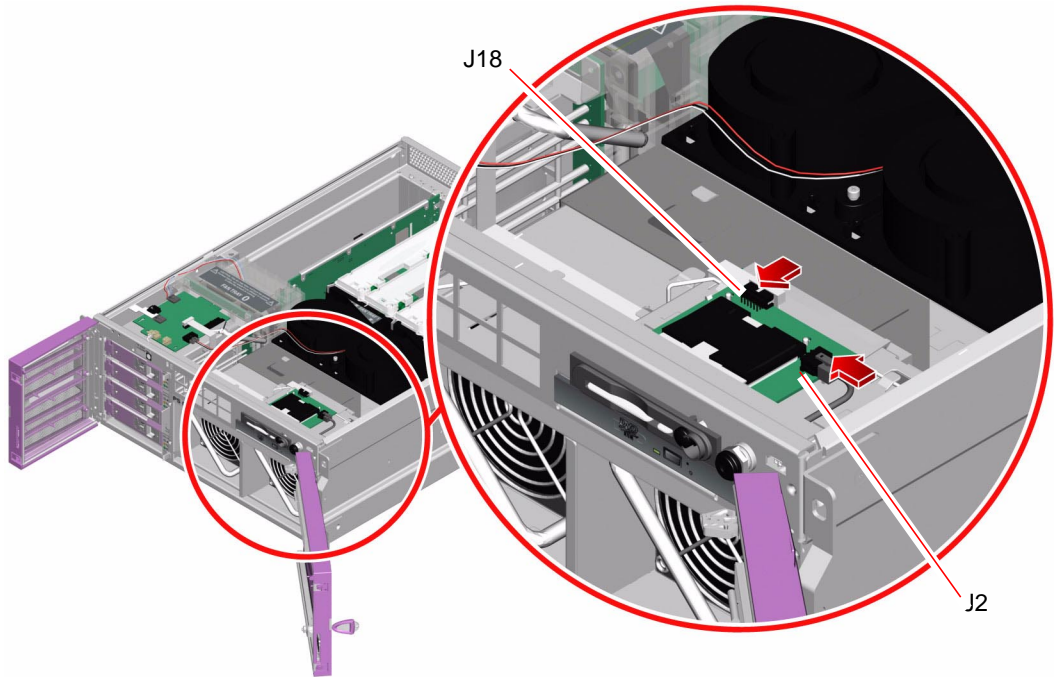

5. **Connect the AC power cords to the back of the system.**

## What Next

To reassemble the system, complete these tasks:

- “How to Install the System Configuration Card” on page 120
- “How to Install the Top Cover” on page 35
- “How to Slide the System Into the Cabinet” on page 32
- “How to Power On the System” on page 19

---

## How to Remove the Connector Board

### Before You Begin

Complete these tasks:

- “How to Power Off the System” on page 23
- “How to Slide the System Out of the Cabinet” on page 29
- “How to Avoid Electrostatic Discharge” on page 44
- “How to Remove the Top Cover” on page 34

### What to Do



---

**Caution** – The system supplies power to the connector board even when the system is powered off. To avoid personal injury or damage to the system, you must disconnect the AC power cords before servicing the connector board.

---

1. **Disconnect the AC power cords from the back of the system.**

**2. Disconnect the five cables from the connector board.**

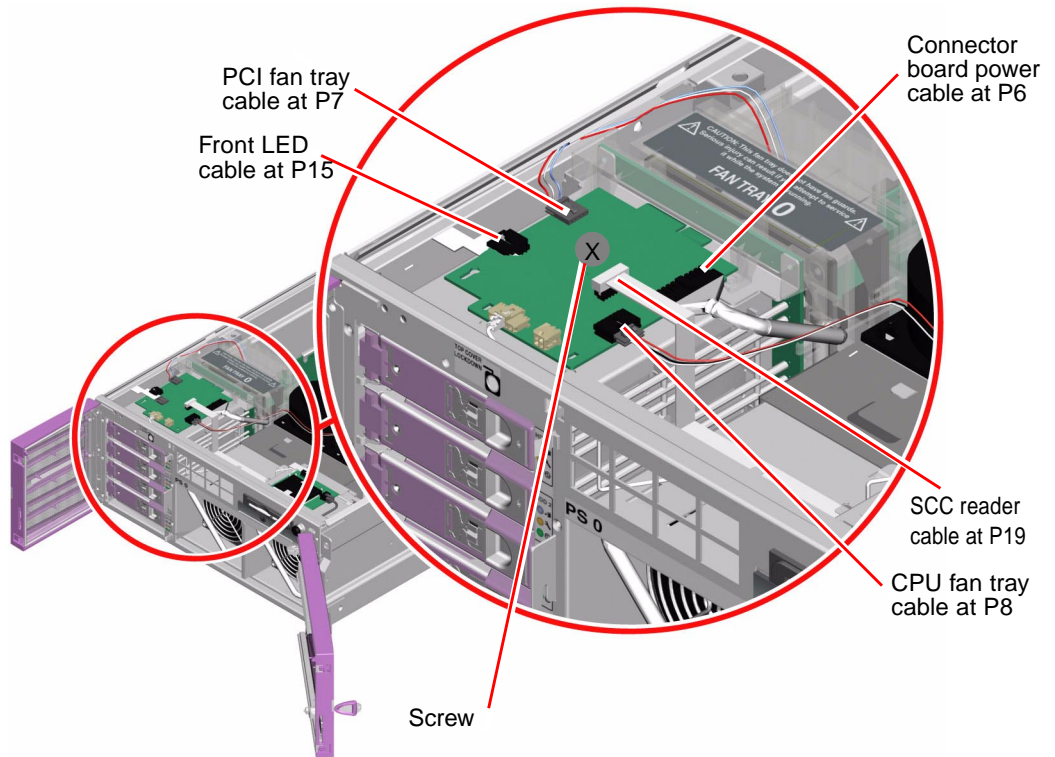

**3. Loosen the Phillips No. 2 captive screw securing the connector board to the chassis.**

**4. Pull the connector board toward the front of the system until it disengages from the SCSI backplane.**

**5. Lift the connector board out of the system.**

Make sure that the connector board clears the two front mounting posts on the chassis.

## What Next

Complete this task:

- “How to Install the Connector Board” on page 128

---

# How to Install the Connector Board

## Before You Begin

Complete this task:

- “How to Remove the Connector Board” on page 126

## What to Do



---

**Caution** – The system supplies power to the connector board even when the system is powered off. To avoid personal injury or damage to the system, you must disconnect the AC power cords before servicing the connector board.

---

- 1. Disconnect the AC power cords from the back of the system.**
- 2. Place the connector board into the chassis.**  
Align the two front mounting posts with the holes in the connector board.
- 3. Slide the connector board toward the back of the system to connect the board to the SCSI backplane.**  
The connector board clicks into place.
- 4. Secure the connector board to the chassis with the Phillips No. 2 captive screw.**

## 5. Connect the five cables to the connector board.

Insert the cable ends into the appropriate connectors. Each connector is unique and matches only one cable end.

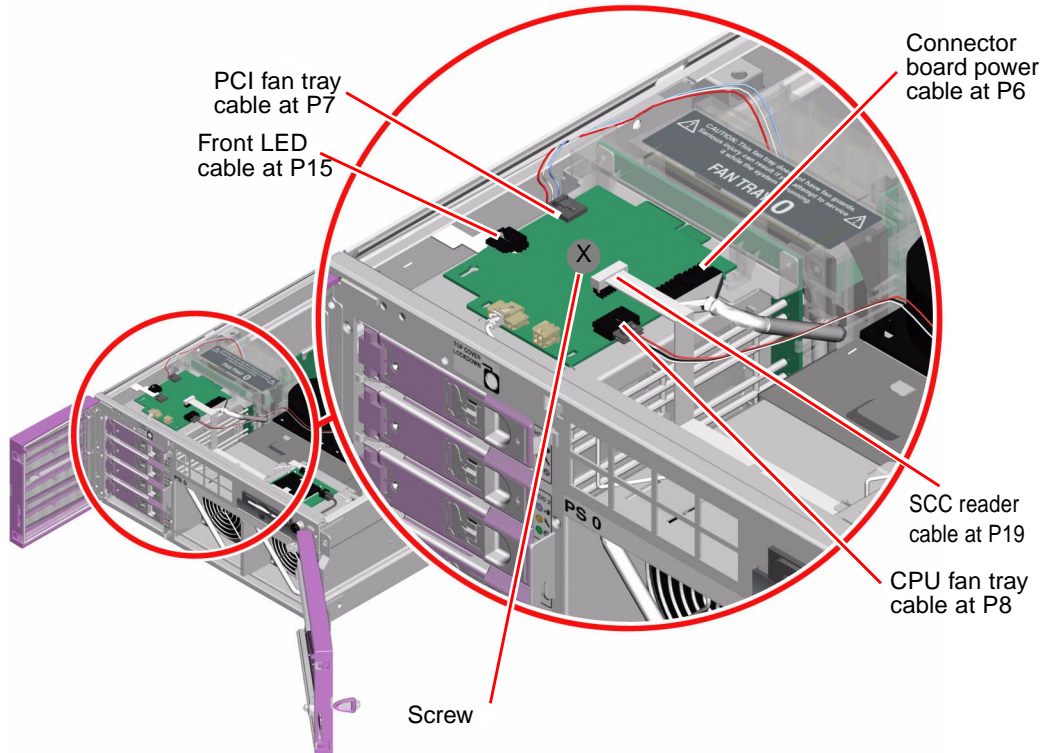

## 6. Connect the AC power cords to the back of the system.

## What Next

To reassemble the system, complete these tasks:

- “How to Install the Top Cover” on page 35
- “How to Slide the System Into the Cabinet” on page 32
- “How to Power On the System” on page 19

---

# How to Remove the SCSI Backplane

## Before You Begin

Complete these tasks:

- “How to Power Off the System” on page 23
- “How to Slide the System Out of the Cabinet” on page 29
- “How to Avoid Electrostatic Discharge” on page 44
- “How to Remove the Top Cover” on page 34
- “How to Remove the PCI Fan Tray” on page 67

## What to Do



---

**Caution** – The system supplies power to the SCSI backplane even when the system is powered off. To avoid personal injury or damage to the system, you must disconnect the AC power cords before servicing the SCSI backplane.

---

1. **Disconnect the AC power cords from the back of the system.**
2. **Disengage the hard disks from the SCSI backplane.**
  - a. **Pinch the disk drive latch sideways to release the disk drive handle.**
  - b. **Pull the handle away from the disk drive until you feel the disk drive connector disengage from the SCSI backplane connector.**
  - c. **Repeat Step a and Step b for each disk drive.**
3. **Loosen the Phillips No. 2 captive screw securing the connector board to the chassis.**
4. **Disengage the connector board from the SCSI backplane.**

Pull the connector board forward until it is disconnected from the SCSI backplane.

5. Loosen the two Phillips No. 2 captive screws securing the SCSI backplane to the chassis.
6. Disconnect the P4 SCSI data cable end from the SCSI backplane.  
Pull the cable end out of its connector.

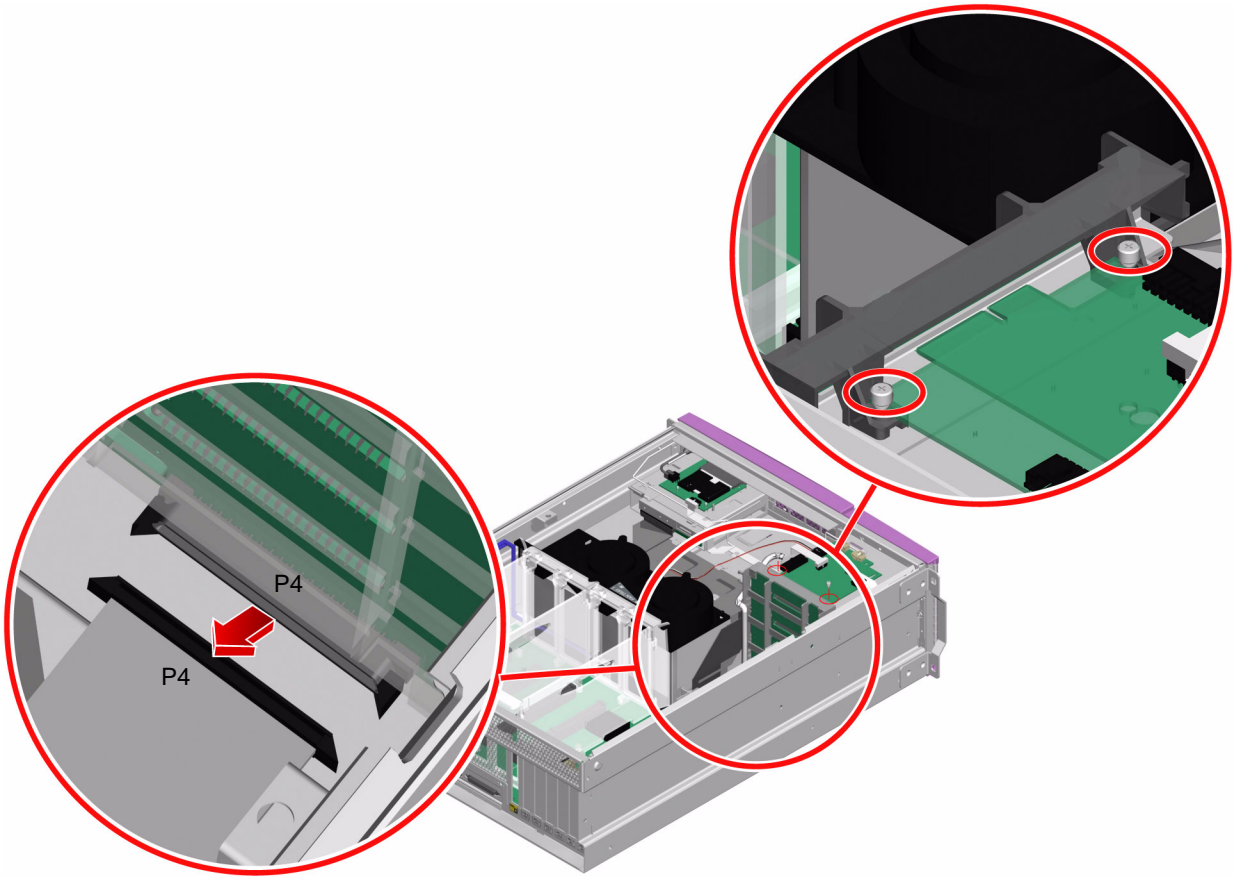

**7. Pull the SCSI backplane up and out of the system.**

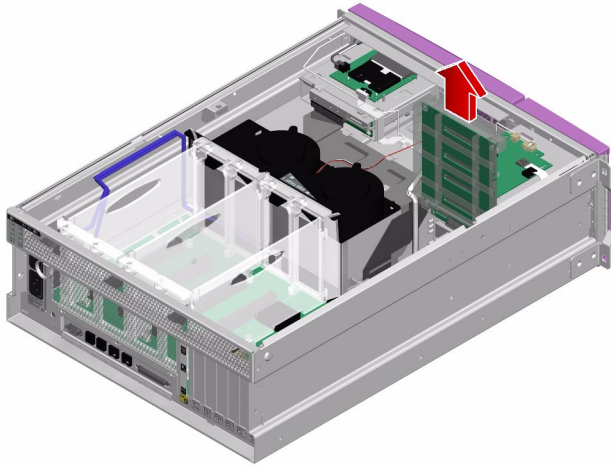

## What Next

Complete this task:

- “How to Install the SCSI Backplane” on page 133



---

# How to Install the SCSI Backplane

## Before You Begin

Complete this task:

- “How to Remove the SCSI Backplane” on page 130

## What to Do



---

**Caution** – The system supplies power to the SCSI backplane even when the system is powered off. To avoid personal injury or damage to the system, you must disconnect the AC power cords before servicing the SCSI backplane.

---

1. **Disconnect the AC power cords from the back of the system.**

**2. Connect the P4 SCSI data cable end at P4 on the SCSI backplane.**

Connect the cable before you install the SCSI backplane into the system.

**3. Place the SCSI backplane into the system so the metal tabs on the bottom of the chassis align with the holes in the bottom of the SCSI backplane.**

Make sure that the two Phillips No. 2 captive screws align with their screw holes.

---

**Note** – Make sure that the connector board does not come in contact with the SCSI backplane at this point in the installation.

---

**4. Tighten the two Phillips No. 2 captive screws that secure the SCSI backplane to the chassis.**

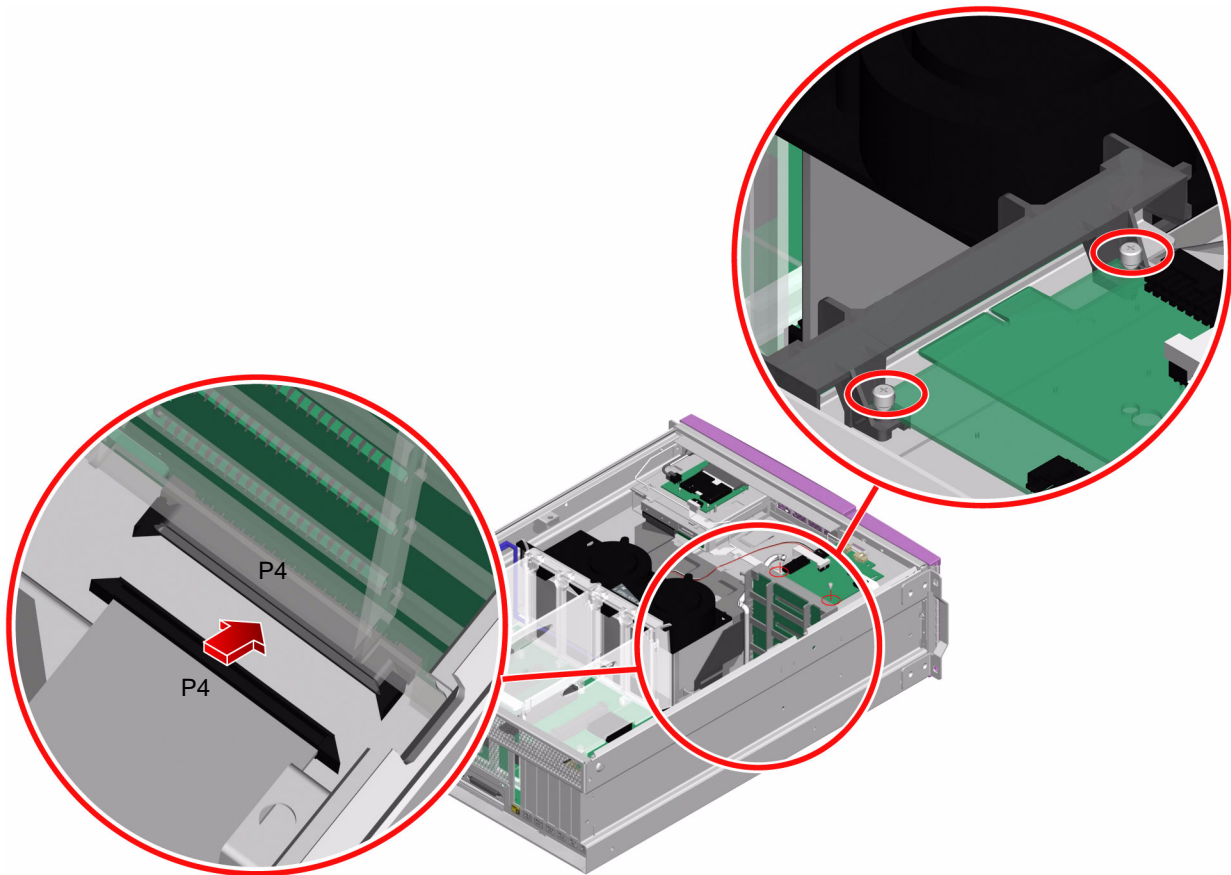

- 5. Slide the connector board toward the back of the system to connect the board to the SCSI backplane.**  
Push the connector board into the SCSI backplane until it is secure.
- 6. Tighten the Phillips No. 2 captive screw to secure the connector board to the chassis.**
- 7. Install the disk drives.**
  - a. Firmly press the center of the disk drive handle toward the disk drive until the latch closes, securing the disk drive in place.**
  - b. Repeat Step a for each disk drive.**
- 8. Connect the AC power cords to the back of the system.**

## What Next

To reassemble the system, complete these tasks:

- “How to Install the PCI Fan Tray” on page 70
- “How to Install the Top Cover” on page 35
- “How to Slide the System Into the Cabinet” on page 32
- “How to Power On the System” on page 19



## Servicing Cables

---

This chapter contains the following sections:

- “Cable Connections and Routing” on page 138
- “How to Remove the SCC Reader Cable” on page 139
- “How to Install the SCC Reader Cable” on page 141
- “How to Remove the SCSI Data Cable” on page 150
- “How to Install the SCSI Data Cable” on page 151
- “How to Remove the Connector Board Power Cable” on page 146
- “How to Install the Connector Board Power Cable” on page 148
- “How to Remove the System Control Keyswitch Cable” on page 142
- “How to Install the System Control Keyswitch Cable” on page 144
- “How to Remove the DVD-ROM Cable” on page 152
- “How to Install the DVD-ROM Cable” on page 154

---

# Cable Connections and Routing

Use the following table as a guide for connecting and routing system cables. Match cable ends with the corresponding board connectors. The next sections describe how to remove and install these cables.

**TABLE 7-1** Cable Connections and Routing

<b>Cable Name and Part Number</b>	<b>Routed From</b>	<b>Routed To</b>	<b>Cable Management Notes</b>
SCC Reader Cable (530-3151)	Connector board at P19	SCC reader at J18	Tuck cable under the two metal tabs on the chassis on top of power supply 0.
System Control Keyswitch Cable (530-3148)	SCC reader at J2	Keyswitch faceplate	
Connector Board Power Cable (530-3145)	Motherboard at P5	Connector board at P6	Route between the PCI fan tray and the CPU fan tray, underneath the crossbar. Route cable through the cable guide on the side of the SCSI backplane.
SCSI Data Cable (530-2144)	Motherboard at P3	SCSI backplane at P4	
DVD-ROM Cable (375-3104)	Motherboard at P1	DVD-ROM drive at J1	Route across power supply bays, down the side of power supply bay 0.

---

# How to Remove the SCC Reader Cable

## Before You Begin

Complete these tasks:

- “How to Power Off the System” on page 23
- “How to Slide the System Out of the Cabinet” on page 29
- “How to Avoid Electrostatic Discharge” on page 44
- “How to Remove the Top Cover” on page 34

## What to Do



---

**Caution** – The system supplies power to the system configuration card reader cable even when the system is powered off. To avoid personal injury or damage to the system, you must disconnect the AC power cords before servicing the system configuration card reader cable.

---

1. **Disconnect the AC power cords from the back of the system.**

2. **Disconnect the SCC reader cable end at P19 on the connector board.**  
Pull up on the cable end to release it from its connector.
3. **Disconnect the SCC reader cable end at J18 on the SCC reader.**  
Pull the cable end off its connector.

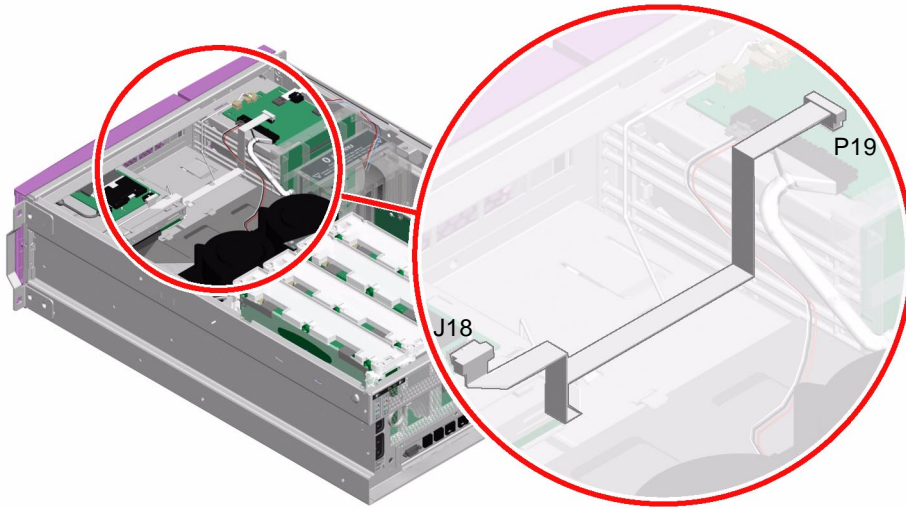

## What Next

Complete this task:

- “How to Install the SCC Reader Cable” on page 141



---

# How to Install the SCC Reader Cable

## Before You Begin

Complete this task:

- “How to Remove the SCC Reader Cable” on page 139

## What to Do



---

**Caution** – The system supplies power to the system configuration card reader cable even when the system is powered off. To avoid personal injury or damage to the system, you must disconnect the AC power cords before servicing the system configuration card reader cable.

---

1. **Connect the SCC reader cable at J18 on the SCC reader.**

Push the cable end into the connector.

2. **Connect the SCC reader cable at P19 on the connector board.**

Push the cable end into the connector.

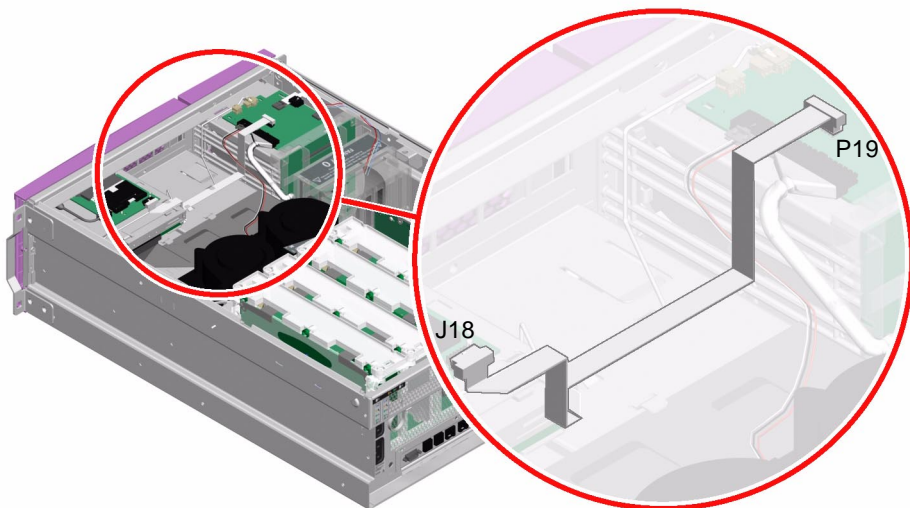

3. Tuck the cable under the two metal tabs located on the chassis above power supply 0.
4. Connect the AC power cords to the back of the system.

## What Next

Complete these tasks:

- “How to Install the Top Cover” on page 35
- “How to Slide the System Into the Cabinet” on page 32
- “How to Power On the System” on page 19

---

# How to Remove the System Control Keyswitch Cable

## Before You Begin

Complete these tasks:

- “How to Power Off the System” on page 23
- “How to Slide the System Out of the Cabinet” on page 29
- “How to Avoid Electrostatic Discharge” on page 44
- “How to Remove the Top Cover” on page 34

## What to Do



---

**Caution** – The system supplies power to the system control keyswitch cable even when the system is powered off. To avoid personal injury or damage to the system, you must disconnect the AC power cords before servicing the system control keyswitch cable.

---

1. Disconnect the AC power cords from the back of the system.

2. **Disconnect the system control keyswitch cable end at J2 on the SCC reader.**  
Press the locking tab on the cable end and pull it off its connector.
3. **Disconnect the system control keyswitch cable from the keyswitch faceplate.**  
Pull the cable end gently off the keyswitch faceplate.

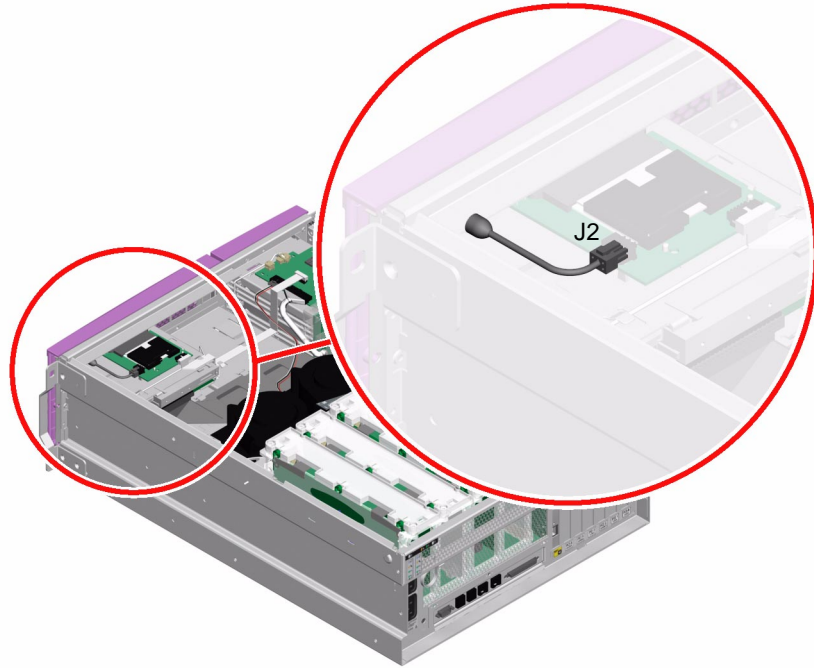

## What Next

Complete this task:

- “How to Install the System Control Keyswitch Cable” on page 144

---

# How to Install the System Control Keyswitch Cable

## Before You Begin

Complete this task:

- “How to Remove the System Control Keyswitch Cable” on page 142

## What to Do



---

**Caution** – The system supplies power to the system control keyswitch cable even when the system is powered off. To avoid personal injury or damage to the system, you must disconnect the AC power cords before servicing the system control keyswitch cable.

---

- 1. Connect the system control keyswitch cable end to the keyswitch faceplate.**  
Press the cable end into the keyswitch faceplate.

2. Connect the J2 system control keyswitch cable end at J2 on the SCC reader.  
Press the cable end into its connector.

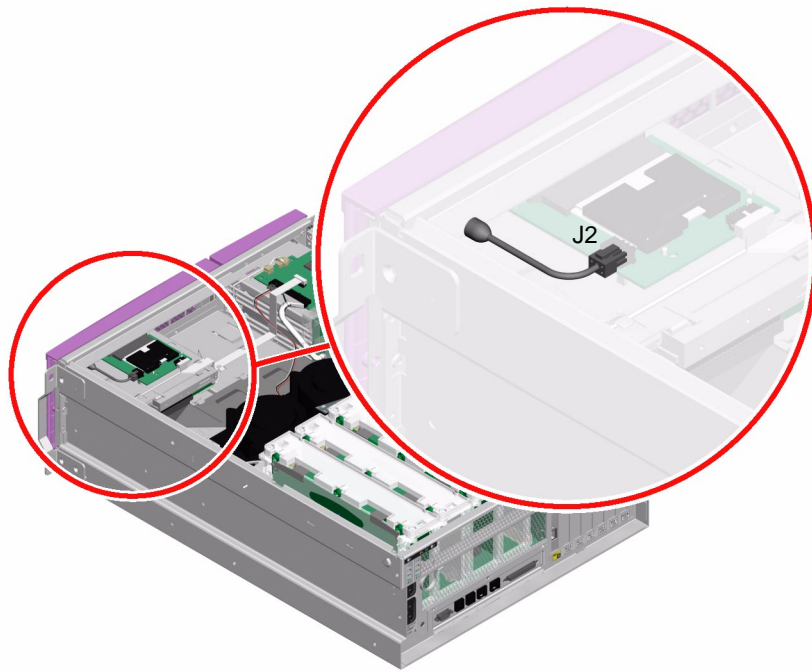

3. Connect the AC power cords to the back of the system.

## What Next

Complete these tasks:

- “How to Install the Top Cover” on page 35
- “How to Slide the System Into the Cabinet” on page 32
- “How to Power On the System” on page 19

---

# How to Remove the Connector Board Power Cable

## Before You Begin

Complete these tasks:

- “How to Power Off the System” on page 23
- “How to Slide the System Out of the Cabinet” on page 29
- “How to Avoid Electrostatic Discharge” on page 44
- “How to Remove the Top Cover” on page 34

## What to Do



---

**Caution** – The system supplies power to the connector board power cable even when the system is powered off. To avoid personal injury or damage to the system, you must disconnect the AC power cords before servicing the connector board power cable.

---

1. **Disconnect the AC power cords from the back of the system.**

**2. Disconnect the P5 cable end at P5 on the motherboard.**

Press the locking tab on the cable end and pull the cable out of its connector.

**3. Disconnect the P6 cable end at P6 on the connector board.**

Press the locking tab on the cable end and pull the cable out of its connector.

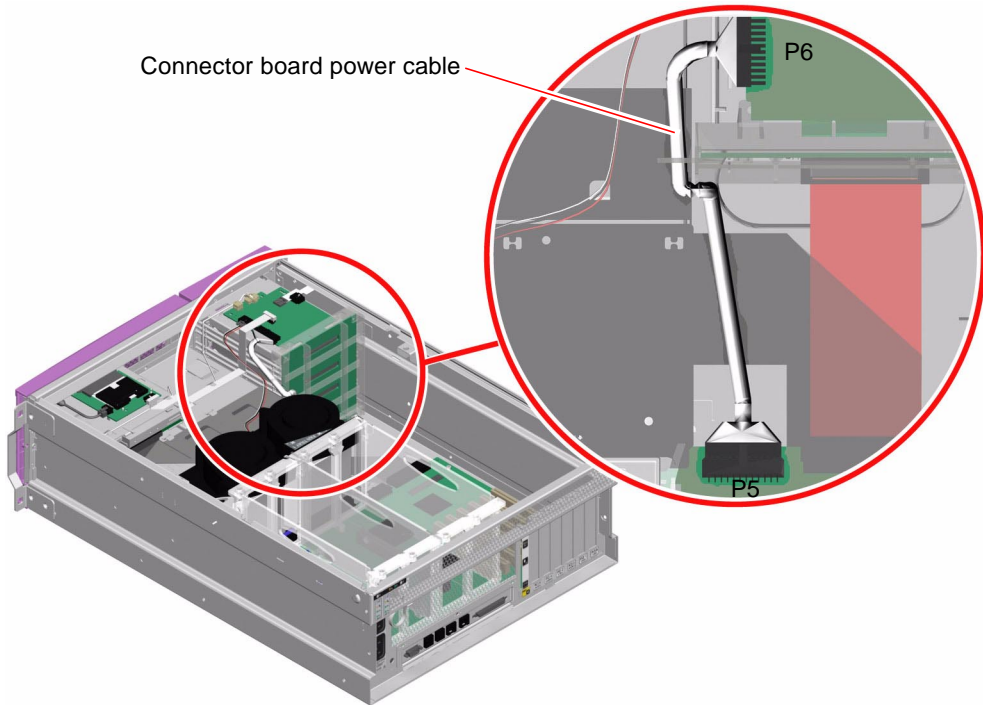

## What Next

Complete this task:

- “How to Install the Connector Board Power Cable” on page 148

---

# How to Install the Connector Board Power Cable

## Before You Begin

Complete this task:

- “How to Remove the Connector Board Power Cable” on page 146

## What to Do



---

**Caution** – The system supplies power to the connector board power cable even when the system is powered off. To avoid personal injury or damage to the system, you must disconnect the AC power cords before servicing the connector board power cable.

---

1. **Connect the P6 cable end at P6 on the connector board.**
2. **Connect the P5 cable end at P5 on the motherboard.**



### 3. Connect the AC power cords to the back of the system.

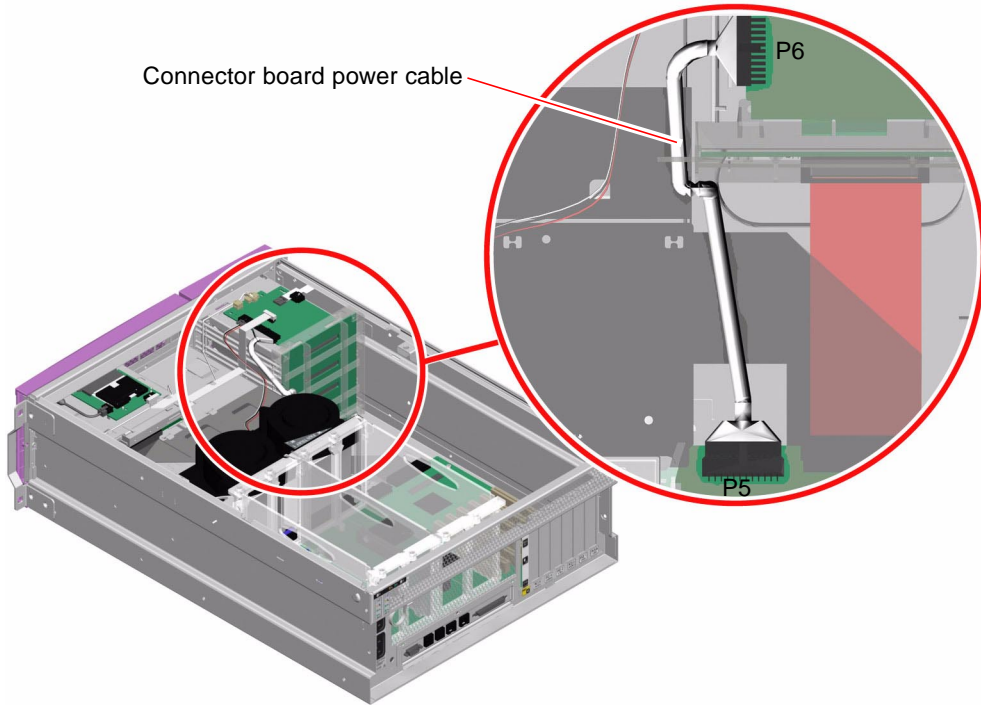

## What Next

Complete these tasks:

- “How to Install the Top Cover” on page 35
- “How to Slide the System Into the Cabinet” on page 32
- “How to Power On the System” on page 19

---

# How to Remove the SCSI Data Cable

## Before You Begin

Complete these tasks:

- “How to Power Off the System” on page 23
- “How to Slide the System Out of the Cabinet” on page 29
- “How to Avoid Electrostatic Discharge” on page 44
- “How to Remove the Top Cover” on page 34
- “How to Remove the PCI Fan Tray” on page 67

## What to Do

1. **Disconnect the P3 cable end at P3 on the motherboard.**

Pull the cable end out of its connector.

2. **Disconnect the P4 cable end at P4 on the SCSI backplane.**

Pull the cable end out of its connector.

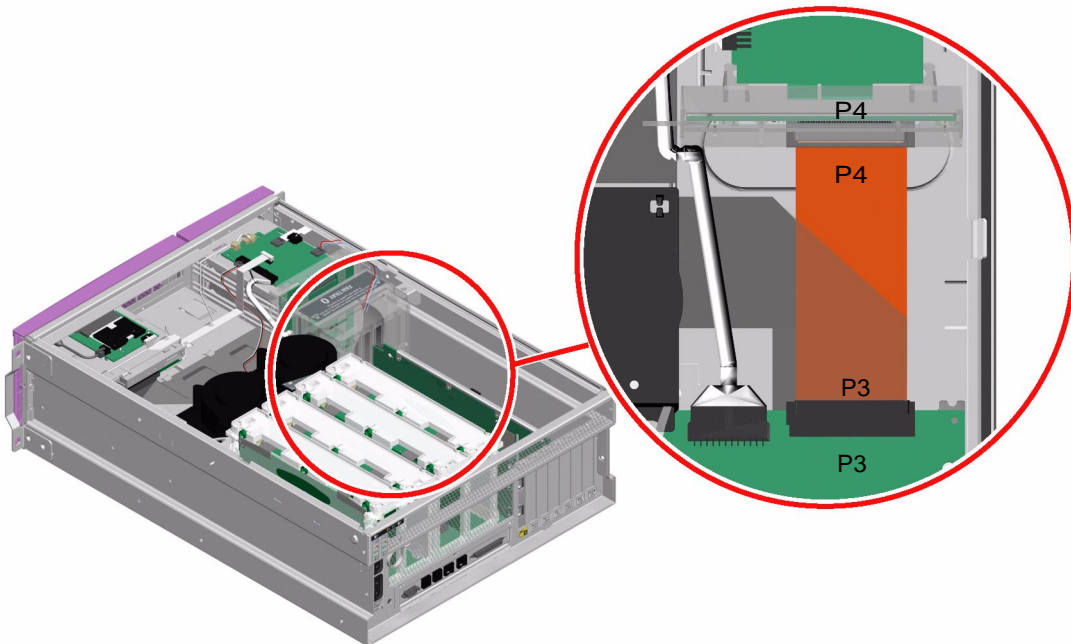

## What Next

Complete this task:

- “How to Install the SCSI Data Cable” on page 151

---

# How to Install the SCSI Data Cable

## Before You Begin

Complete this task:

- “How to Remove the SCSI Data Cable” on page 150

## What to Do

1. Connect the P4 cable end at P4 on the SCSI backplane.
2. Connect the P3 cable end at P3 on the motherboard.

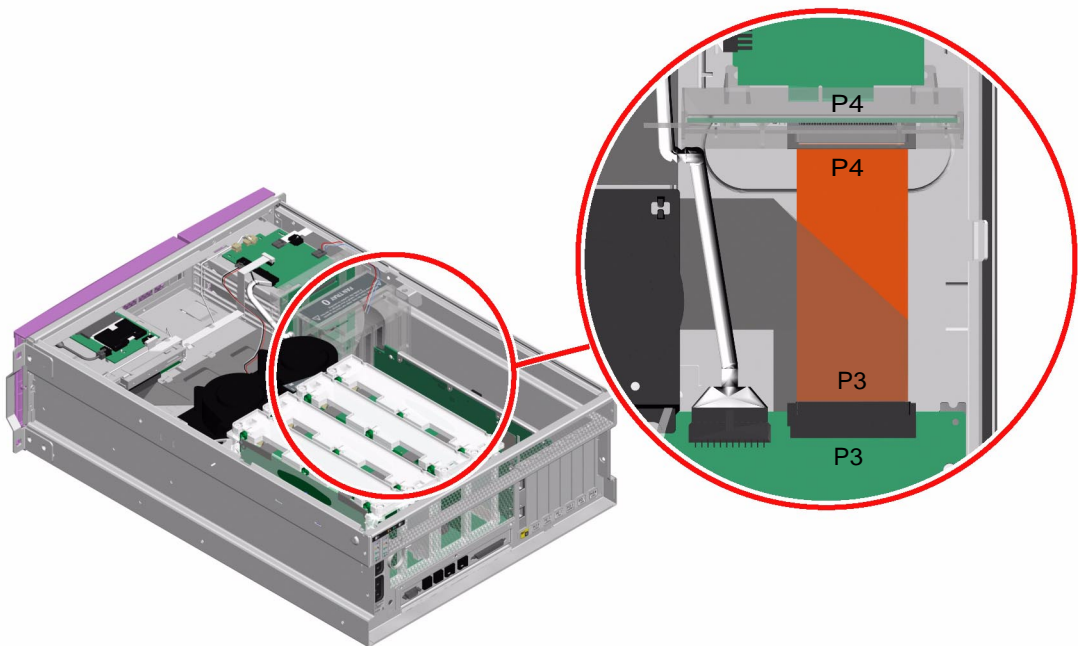

## What Next

Complete these tasks:

- “How to Install the PCI Fan Tray” on page 70
- “How to Install the Top Cover” on page 35
- “How to Slide the System Into the Cabinet” on page 32
- “How to Power On the System” on page 19

---

## How to Remove the DVD-ROM Cable

### Before You Begin

Complete these tasks:

- “How to Power Off the System” on page 23
- “How to Slide the System Out of the Cabinet” on page 29
- “How to Avoid Electrostatic Discharge” on page 44
- “How to Remove the Top Cover” on page 34
- “How to Remove the PCI Fan Tray” on page 67
- “How to Remove the CPU Fan Tray” on page 73

### What to Do

**1. Disconnect the P1 cable end at P1 on the motherboard.**

Lift the locking levers on the sides of the connector to release the cable end.

2. Using a Phillips No. 1 screwdriver, remove the two screws securing the DVD-ROM cable end to the DVD-ROM drive.

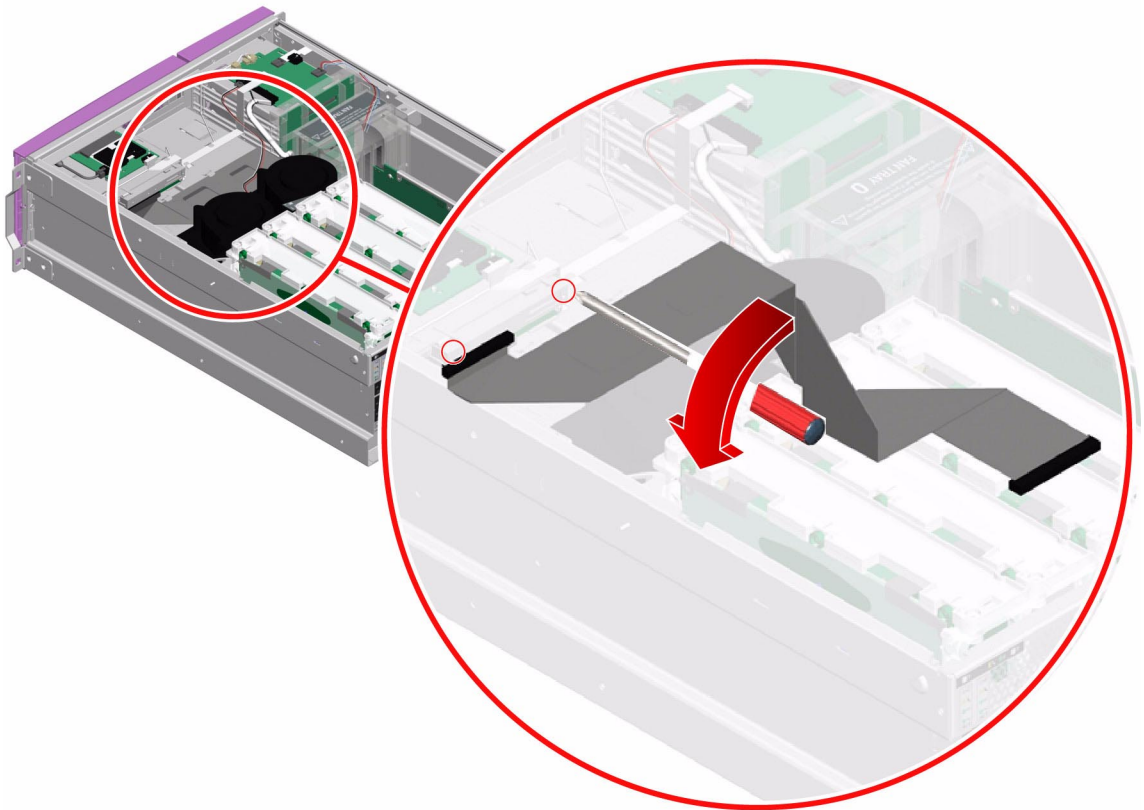

## What Next

Complete this task:

- “How to Install the DVD-ROM Cable” on page 154

---

# How to Install the DVD-ROM Cable

## Before You Begin

Complete this task:

- “How to Remove the DVD-ROM Cable” on page 152

## What to Do

- 1. Using a Phillips No. 1 screwdriver, attach the two screws that secure the DVD-ROM cable to the DVD-ROM drive.**
- 2. Route the DVD-ROM cable across the power supply bays and down the side of power supply bay 0.**  
Tuck the cable under three metal tabs on top of the power supply bays and one tab on the side of power supply bay 0.

3. **Connect the P1 cable end at P1 on the motherboard.**
  - a. **Make sure that the connector levers are rotated up before inserting the cable.**
  - b. **Press the cable end into the connector until the connector levers lie flat.**

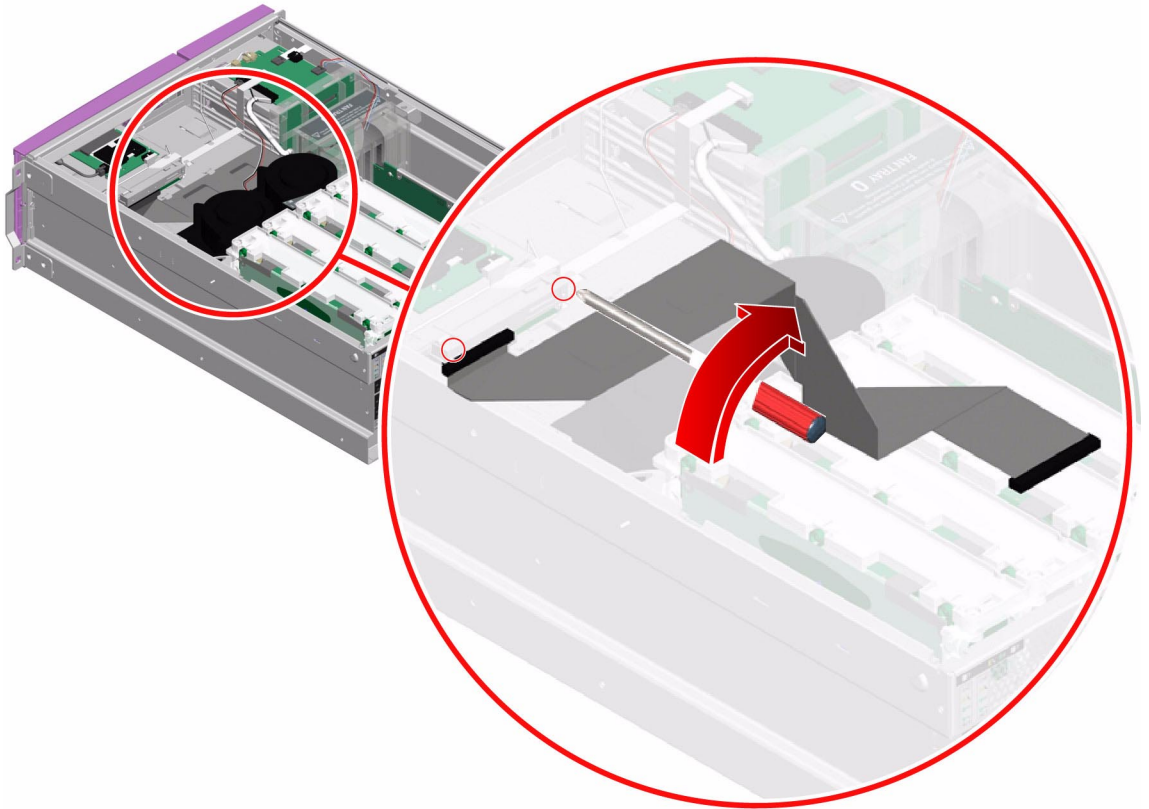

## What Next

Complete these tasks:

- “How to Install the PCI Fan Tray” on page 70
- “How to Install the CPU Fan Tray” on page 75
- “How to Install the Top Cover” on page 35
- “How to Slide the System Into the Cabinet” on page 32
- “How to Power On the System” on page 19





## Connector Pinouts

---

This appendix provides reference information about the system back panel ports and pin assignments.

Topics covered in this appendix include:

- “Reference for the Serial Port Connector” on page 158
- “Reference for the USB Connectors” on page 159
- “Reference for the Gigabit Ethernet Connectors” on page 160
- “Reference for the Network Management Connector” on page 161
- “Reference for the Serial Management Connector” on page 162
- “Reference for the SCSI Connector” on page 163

---

# Reference for the Serial Port Connector

The serial port connector (ttyb) is a DB-9 connector that can be accessed from the back panel.

## Serial Port Connector Diagram

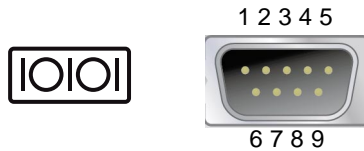

## Serial Port Connector Signals

Pin	Signal Description	Pin	Signal Description
1	Data Carrier Detect	6	Data Set Ready
2	Receive Data	7	Request to Send
3	Transmit Data	8	Clear to Send
4	Data Terminal Ready	9	Ring Indicate
5	Ground		

---

# Reference for the USB Connectors

Four Universal Serial Bus (USB) ports are located on the motherboard in a double-stacked layout and can be accessed from the back panel.

## USB Connector Diagram

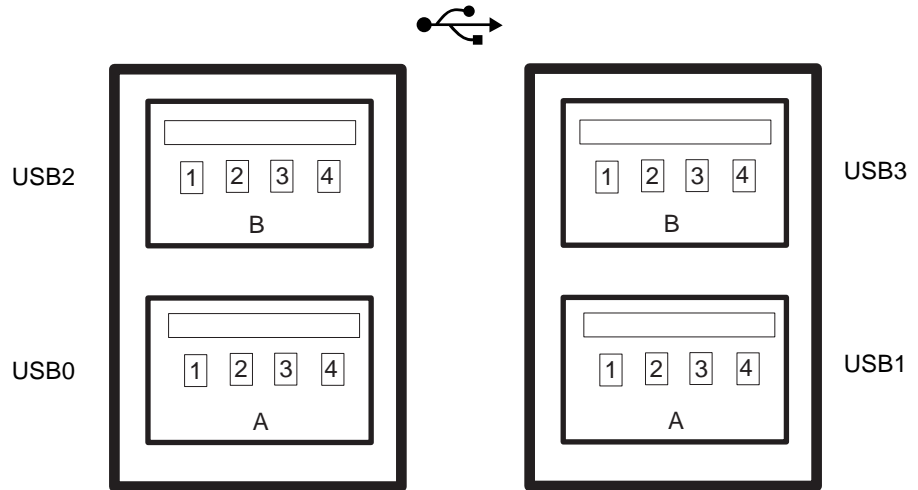

## USB Connector Signals

Pin	Signal Description	Pin	Signal Description
A1	+5 V (fused)	B1	+5 V (fused)
A2	USB0/1-	B2	USB2/3-
A3	USB0/1+	B3	USB2/3+
A4	Ground	B4	Ground

---

# Reference for the Gigabit Ethernet Connectors

Two RJ-45 Gigabit Ethernet connectors (net0, net1) are located on the system motherboard and can be accessed from the back panel. The Ethernet interfaces operate at 10 Mbps, 100 Mbps, and 1000 Mbps.

## Gigabit Ethernet Connector Diagram

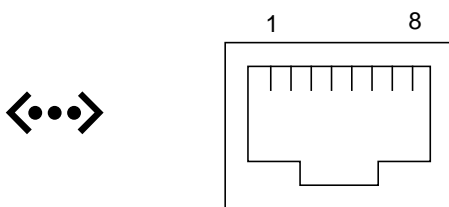

## Gigabit Ethernet Connector Signals

Pin	Signal Description	Pin	Signal Description
1	Transmit/Receive Data 0 +	5	Transmit/Receive Data 2 -
2	Transmit/Receive Data 0 -	6	Transmit/Receive Data 1 -
3	Transmit/Receive Data 1 +	7	Transmit/Receive Data 3 +
4	Transmit/Receive Data 2 +	8	Transmit/Receive Data 3 -

---

# Reference for the Network Management Connector

The network management connector (labeled NET MGT) is an RJ-45 connector located on the ALOM card and can be accessed from the back panel. This port needs to be configured prior to use.

## Network Management Connector Diagram

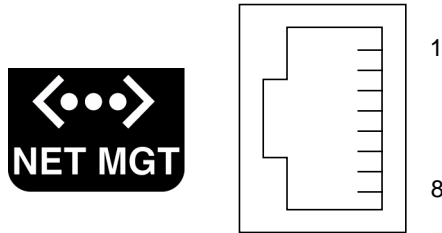

## Network Management Connector Signals

Pin	Signal Description	Pin	Signal Description
1	Transmit Data +	5	Common Mode Termination
2	Transmit Data -	6	Receive Data -
3	Receive Data +	7	Common Mode Termination
4	Common Mode Termination	8	Common Mode Termination

---

# Reference for the Serial Management Connector

The serial management connector (labeled SERIAL MGT) is an RJ-45 connector located on the ALOM card and can be accessed from the back panel. This port is the default connection to the system.

## Serial Management Connector Diagram

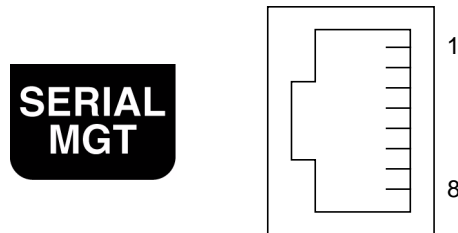

## Serial Management Connector Signals

Pin	Signal Description	Pin	Signal Description
1	Request to Send	5	Ground
2	Data Terminal Ready	6	Receive Data
3	Transmit Data	7	Data Set Ready
4	Ground	8	Clear to Send

---

# Reference for the SCSI Connector

The SCSI serial data connector is located on the motherboard and can be accessed from the back panel.

## SCSI Connector Diagram

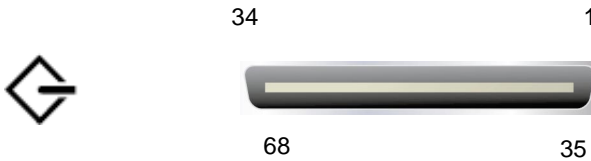

## SCSI Connector Signals

Pin	Signal Description	Pin	Signal Description
1	Data12 +	35	Data12 -
2	Data13 +	36	Data13 -
3	Data14 +	37	Data14 -
4	Data15 +	38	Data15 -
5	Parity1 +	39	Parity1 -
6	Data0 +	40	Data0 -
7	Data1 +	41	Data1 -
8	Data2 +	42	Data2 -
9	Data3 +	43	Data3 -
10	Data4 +	44	Data4 -
11	Data5 +	45	Data5 -

<b>Pin</b>	<b>Signal Description</b>	<b>Pin</b>	<b>Signal Description</b>
12	Data6 +	46	Data6 -
13	Data7 +	47	Data7 -
14	Parity0 +	48	Parity0 -
15	Ground	49	Ground
16	DIFF_SENSE	50	Ground
17	TERM_PWR	51	TERM_PWR
18	TERM_PWR	52	TERM_PWR
19	(N/C)	53	(N/C)
20	Ground	54	Ground
21	ATN +	55	ATN -
22	Ground	56	Ground
23	BSY +	57	BSY -
24	ACK +	58	ACK -
25	RST +	59	RST -
26	MSG +	60	MSG -
27	SEL +	61	SEL -
28	CD +	62	CD -
29	REQ +	63	REQ -
30	I/O +	64	I/O -
31	Data8 +	65	Data8 -
32	Data9 +	66	Data9 -
33	Data10 +	67	Data10 -
34	Data11 +	68	Data11 -



## System Specifications

---

This appendix provides the following specifications for the Sun Fire V440 server:

- “Reference for Physical Specifications” on page 166
- “Reference for Electrical Specifications” on page 166
- “Reference for Environmental Specifications” on page 167
- “Reference for Agency Compliance Specifications” on page 168
- “Reference for Clearance and Service Access Specifications” on page 168

---

## Reference for Physical Specifications

Measurement	U.S.	Metric
Height	6.85 in	17.4 cm
Width	17.48 in	44.4 cm
Depth	25 in	63.5 cm
Weight:		
Minimum	70 lbs	31 kg
Maximum	82 lbs	37.2 kg
Power Cord	8.2 ft	2.5 m

---

## Reference for Electrical Specifications

The following table provides the electrical specifications for the system. All specifications pertain to a fully configured system operating at 50 Hz to 60 Hz.

Parameter	Value
<b>Input</b>	
Nominal Frequencies	50 to 60 Hz
Nominal Voltage Range	100 to 240 VAC
Maximum Current AC RMS *	9.3A @ 100 VAC 7.7A @ 120 VAC 4.6A @ 200 VAC 4.45A @ 208 VAC 4.2A @ 220 VAC 4.0A @ 230 VAC 3.65A @ 240 VAC
<b>Output</b>	
+12 VDC	0.5 to 45A
-12 VDC	0 to 0.8A
+5 VDC	0.5 to 28A
-5 VDC	0.5 to 50A
Maximum DC Output of Power Supply	680 W
Maximum AC Power Consumption	925W for operation @ 100 VAC to 240 VAC
Maximum Heat Dissipation	3157 Btu/hr for operation @ 100 VAC to 240 VAC

\* Refers to total input current required for both AC inlets when operating with dual power supplies or current required for a single AC inlet when operating with a single power supply.

---

# Reference for Environmental Specifications

The operating and non-operating environmental specifications for the system are as follows.

Parameter	Value
<b>Operating</b>	
Temperature	5°C to 40°C (41°F to 104°F) noncondensing—IEC 60068-2-1&2
Humidity	20% to 80% RH noncondensing; 27°C max wet bulb—IEC 60068-2-3&56
Altitude	0 to 3000 meters (0 to 10,000 feet)—IEC 60068-2-13
Vibration (random)	0.0001 g <sup>2</sup> /Hz, 5 to 150 Hz, -12db/octave slope 150 to 500 Hz
Shock	3.0 g peak, 11 milliseconds half-sine pulse—IEC 60068-2-27
<b>Non-Operating</b>	
Temperature	-40°C to 60°C (-40°F to 140°F) noncondensing—IEC 60068-2-1&2
Humidity	93% RH noncondensing; 38°C max wet bulb—IEC 60068-2-3&56
Altitude	0 to 12,000 meters (0 to 40,000 feet)—IEC 60068-2-13
Vibration	0.001 g <sup>2</sup> /Hz, 5 to 150 Hz, -12db/octave slope 150 to 500 Hz
Shock	15.0 g peak, 11 milliseconds half-sine pulse; 1.0 inch roll-off front to back, 0.5 inch roll-off side to side—IEC 60068-2-27
Handling Drops	60 mm, 1 drop per corner, 4 corners—IEC 60068-2-31
Threshold Impact	0.85m/s, 3 impacts per caster, all 4 casters, 25 mm step-up—ETE 1010-01

---

## Reference for Agency Compliance Specifications

The system complies with the following specifications.

Category	Relevant Standards
Safety	UL 60950, CB Scheme IEC 950, CSA C22.2 950 from UL TUV EN 60950
RFI/EMI	47 CFR 15B Class A EN55022 Class A VCCI Class B ICES-003 AS/NZ 3548 CNS 13438 KSC 5858
Immunity	IEC 1000 EN55024 IEC 61000-4-2 IEC 61000-4-3 IEC 61000-4-4 IEC 61000-4-5 IEC 61000-4-6 IEC 61000-4-8 IEC 61000-4-11

---

---

## Reference for Clearance and Service Access Specifications

Minimum clearances needed for servicing the system are as follows.

Blockage	Required Clearance
Front of System	36 in (91.4 cm)
Back of System	36 in (91.4 cm)

---

## Board Connector Locations

---

This appendix illustrates the connector locations on the system boards. It contains the following sections:

- “Motherboard Connectors” on page 170
- “SCSI Backplane Connectors” on page 171
- “Connector Board Connectors” on page 171
- “ALOM Card Connectors” on page 172
- “SCC Reader Connectors” on page 172

# Motherboard Connectors

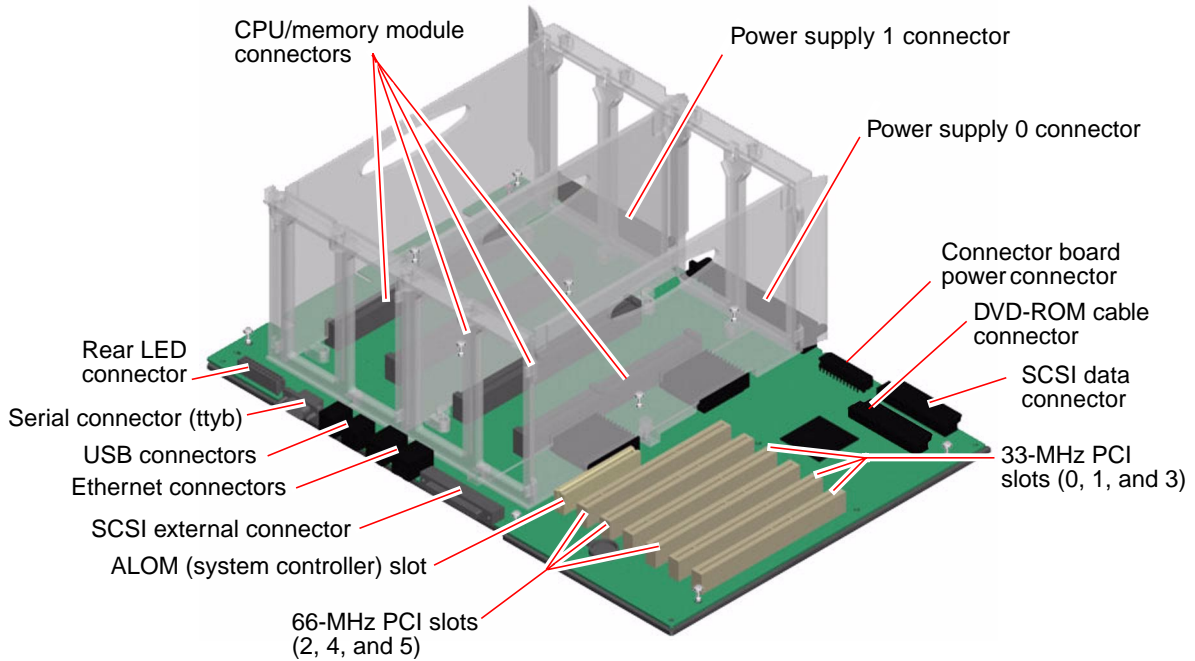

---

# SCSI Backplane Connectors

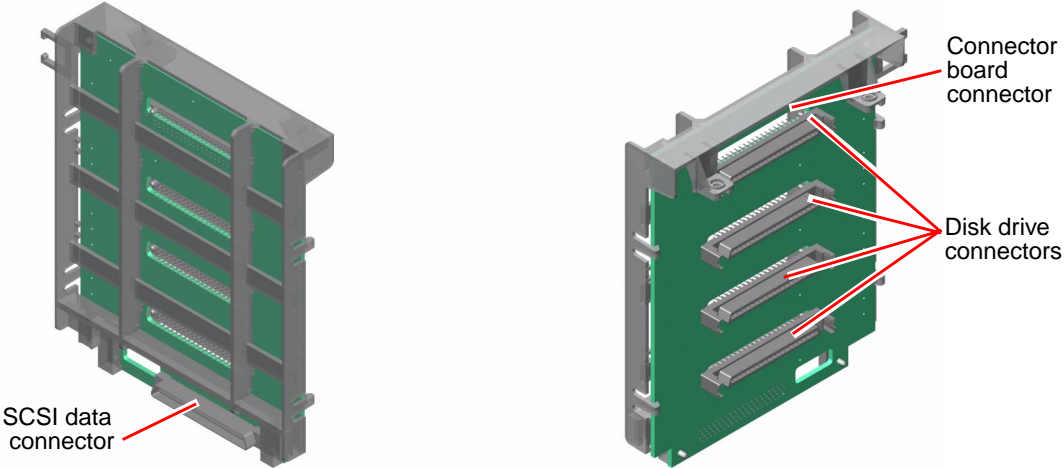

---

# Connector Board Connectors

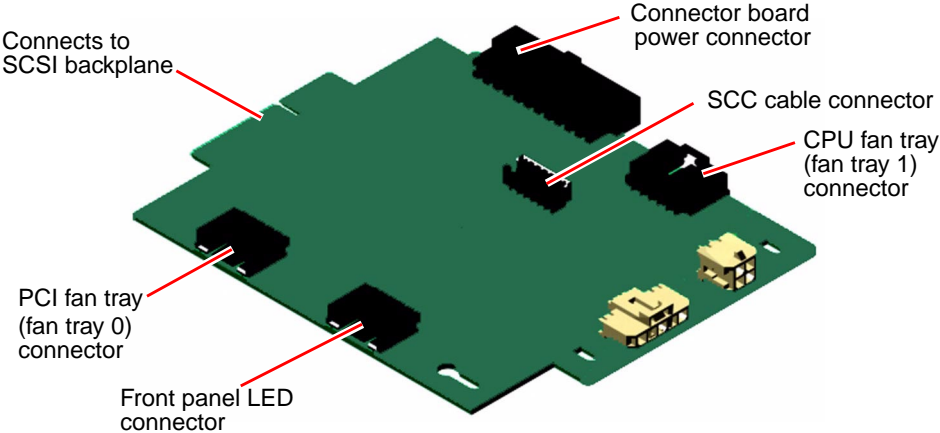

---

## ALOM Card Connectors

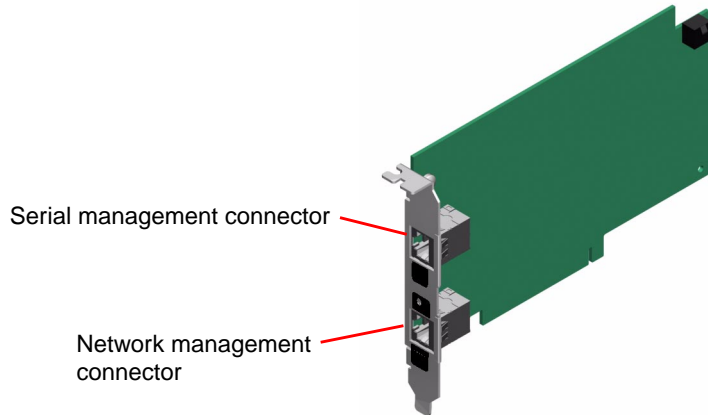

---

## SCC Reader Connectors

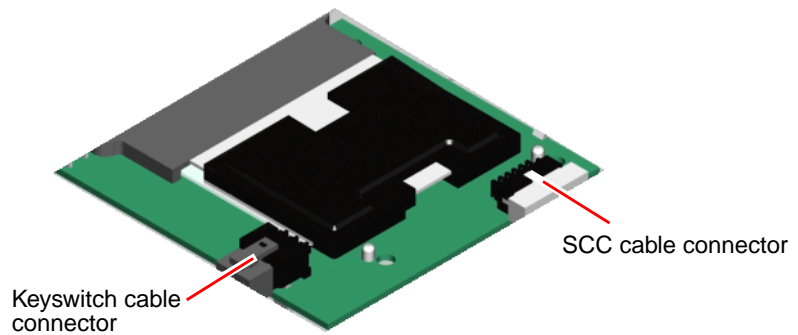



## Illustrated Parts Breakdown

---

This appendix contains a sequence of illustrations that show how the various pieces of the system fit together. Use the accompanying tables as a reference for ordering field-replaceable units (FRUs).

The part numbers listed in the following tables are correct as of the manual publication date but are subject to change without notice. Consult your authorized Sun sales representative or service provider to confirm a part number prior to ordering a replacement part.

This illustrated parts breakdown is divided into the following sections:

- “Front Panel Components” on page 174
- “Fan Components” on page 175
- “Motherboard Components” on page 176
- “Miscellaneous Components” on page 177
- “System Cables” on page 178

# Front Panel Components

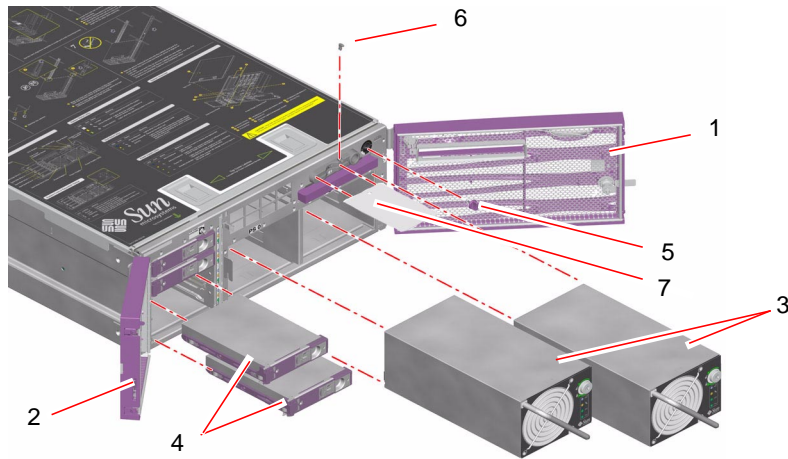

Reference Number	Part	Part Number
1	System door, right	330-3510-03
2	System door, left	330-3509-03
3	Power supply	F300-1501
4	36 GB SCSI disk drive	F540-4904
5	System mini-key	240-4429-01
6	SCC security pin	330-3724-01
7	System configuration card	F370-5155
	System key (not shown)	240-4341-01
	Decorative panel, right (not shown)	330-3592-01 (Not a FRU)
	Decorative panel, left (not shown)	330-3630-01 (Not a FRU)

# Fan Components

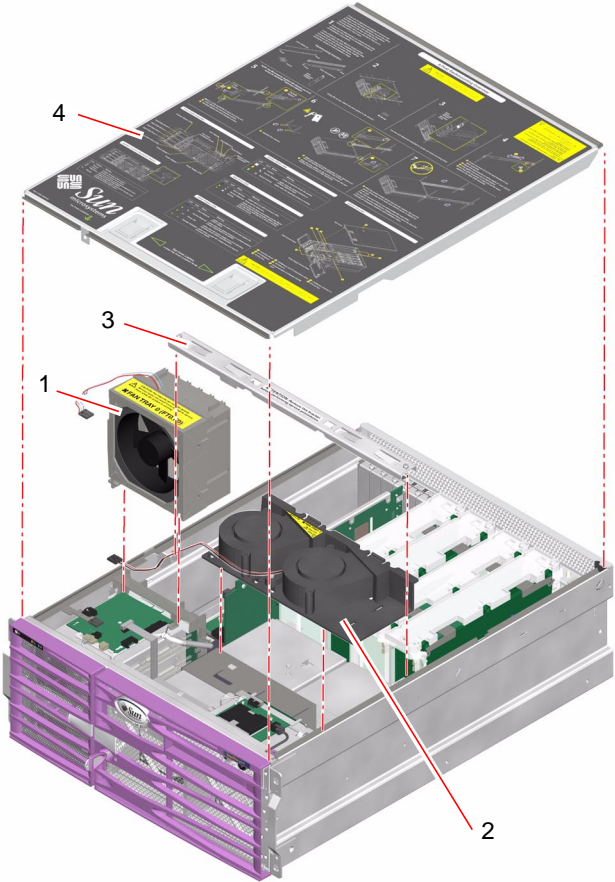

Reference Number	Part	Part Number
1	PCI fan tray (Fan tray 0)	F540-5258
2	CPU fan tray (Fan tray 1)	F540-5383
3	Crossbar	340-7450-03 (Not a FRU)
4	Top cover	340-6871-05 (Not a FRU)

# Motherboard Components

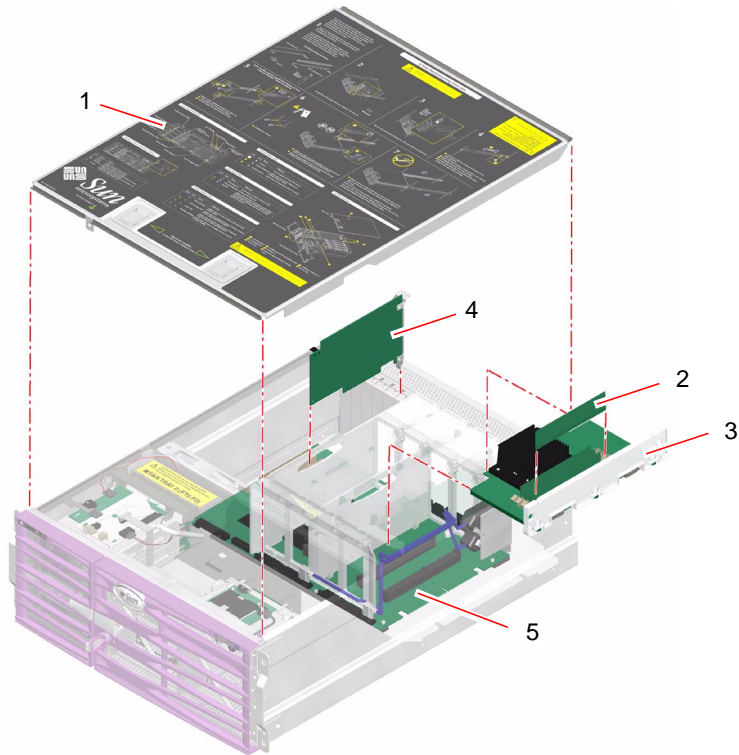

Reference Number	Part	Part Number
1	Top cover	340-6871-05 (Not a FRU)
2	1.062 GHz CPU/memory module	F501-6369
	1.28 GHz CPU/memory module (not shown)	F501-6370
3	512 MB DIMM	F370-4939
	1 GB DIMM (not shown)	F370-4940
4	ALOM card	F501-6346
5	Motherboard	F501-6344
	Rear LED cable (not shown)	370-5576-02 (Not a FRU)

# Miscellaneous Components

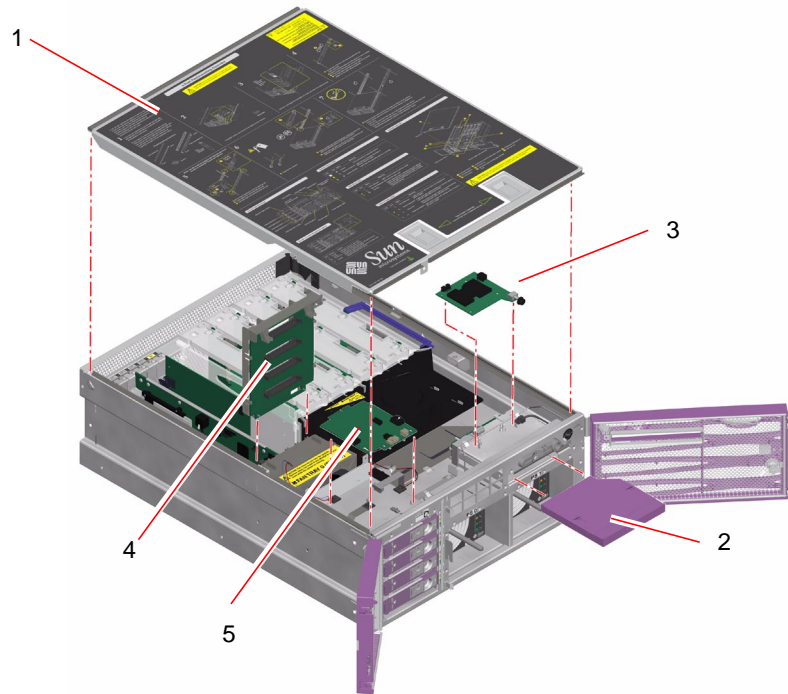

Reference Number	Part	Part Number
1	Top cover	340-6871-05 (Not a FRU)
2	DVD-ROM drive	F540-5596
3	SCC reader	F370-5127
4	SCSI backplane	F501-6335
5	Connector board	F501-6384

---

# System Cables

See TABLE 7-1 for cable connections and routing.

<b>Part</b>	<b>Part Number</b>
SCC reader cable	530-3151
System control keyswitch cable	530-3148
Connector board power cable	530-3145
SCSI data cable	530-3144
DVD-ROM cable	375-3104

# Index

---

## A

- Advanced Lights Out Manager (ALOM) card
  - connectors, 172
  - installing, 99
  - removing, 97
- agency compliance specifications, 168

## B

- booting, after installing new hardware, 26

## C

- cabinet
  - installing the system, 39
  - removing the system, 36
  - sliding the system into, 32
  - sliding the system out of, 29
- cables
  - connections and routing, 138
  - connector board power
    - installing, 148
    - removing, 146
  - DVD-ROM
    - installing, 154
    - removing, 152
  - SCSI data
    - installing, 151
    - removing, 150

- system configuration card (SCC) reader
  - installing, 141
  - removing, 139
- system control keyswitch
  - installing, 144
  - removing, 142

- clearance specifications, 168

### connector board

- connectors, 171
- installing, 128
- removing, 126

### CPU fan tray

- installing, 75
- removing, 73

### CPU/memory module

- installing, 83
- removing, 80

## D

- device trees, rebuilding, 28

### DIMMs

- installing, 90
- removing, 88

### disk drive

- caution, 19
- installing
  - hot-plug operation, 64
  - non-hot-plug operation, 60
- removing
  - hot-plug operation, 62
  - non-hot-plug operation, 57

DVD-ROM drive  
installing, 117  
removing, 116

## E

electrical specifications, 166  
electrostatic discharge (ESD) caution, 44  
environmental specifications, 167

## F

fan tray 0, *See* PCI fan  
fan tray 1, *See* CPU fan tray

## H

hot-pluggable components  
about, 48  
disk drive, installing, 64  
disk drive, removing, 62  
power supply, installing, 55  
power supply, removing, 52

## K

keyswitch, *See* system control keyswitch

## L

light-emitting diodes (LEDs)  
back panel LEDs, 9  
Ethernet LEDs, 10  
network management port LED, 11  
power supply LEDs, 11  
system status LEDs, 9  
front panel LEDs  
disk drive status LEDs, 5  
power supply status LEDs, 6  
system status LEDs, 3

## M

MAC addresses, 119  
memory interleaving, 87  
memory modules  
about, 86  
configuration, 87  
installing, 90  
removing, 88  
mini-key, 2  
motherboard  
connectors, 170  
installing, 107  
removing, 101  
moving the system, caution, 19

## N

network management port (NET MGT), 14

## P

PCI fan  
installing, 70  
removing, 67  
Peripheral Component Interconnect (PCI) card  
installing, 95  
removing, 83, 93  
physical specifications, 166  
power  
specifications, 166  
turning off, 23  
turning on, 19  
power supply  
installing  
hot-plug operation, 55  
non-hot-plug operation, 51  
output capacity, 166  
removing  
hot-plug operation, 52  
non-hot-plug operation, 48  
power-on self-test (POST), 8



## R

reconfiguration boot, initiating, 26

## S

safety agency compliance, 168

SCSI backplane

connectors, 171

installing, 133

removing, 130

security lock, 2

serial management port (SERIAL MGT), 14

service access specifications, 168

specifications

agency compliance, 168

clearance, 168

electrical, 166

environmental, 167

physical, 166

service access, 168

system configuration card (SCC)

installing, 120

removing, 119

system configuration card (SCC) reader

connectors, 172

installing, 124

removing, 122

system control keyswitch, 7

system specifications, *See* specifications

## T

top cover

installing, 35

removing, 34

